

DrayTek

Vigor2762

ADSL2/2+ & VDSL2 Router



Quick Start Guide

V1.0

Vigor2762

ADSL2/2+ & VDSL2 Router

Quick Start Guide

(Wireless models)

Guide Version: 1.0

Region: United Kingdom & Ireland

For updates and support, visit www.draytek.co.uk

February 2018 / Firmware V3.8.8 BT

Note: Product specification is subject to continuous evolution which may not always be reflected in current documentation. For the formal specification and details of the supported features of your product, please refer only to the web site at www.draytek.co.uk

Warranty

We warrant to the original end user (purchaser) that the router will be free from any defects in workmanship or materials for a period of two (2) years from the date of purchase from a DrayTek authorized dealer in the UK/Ireland. Please keep your purchase receipt in a safe place as it serves as proof of date of purchase. During the warranty period, and upon proof of purchase, should the product have indications of failure due to faulty workmanship and/or materials, we will, at our discretion, repair or replace the defective products or components, without charge for either parts or labour, to whatever extent we deem necessary to restore the product to proper operating condition. Any replacement will consist of a new or re-manufactured functionally equivalent product of equal value, and will be offered solely at our discretion. This warranty will not apply if the product is modified, misused, tampered with, damaged by external factors, used with unapproved accessories or subjected to abnormal working conditions. Warranty applies to hardware only, not software or firmware. Defects which do not significantly affect the usability of the product will not be covered by the warranty. We reserve the right to revise the manual and online documentation and to make changes from time to time in the contents hereof without obligation to notify any person of such revision or changes.

European Community Declarations

Manufacturer: DrayTek Corp.
 Address: No. 26, Fu Shing Road, HuKou Township, HsinChu Industrial Park, Hsin-Chu, Taiwan 303
 Product: Vigor 2762 Series

DrayTek Corp. declares that the Vigor2762 Series of routers are in compliance with the following essential requirements and other relevant provisions of Radio Equipment Directive (RED) 2014/53/EU, ErP 2009/125/EC and RoHS 2015/863/EU, Electro-Magnetic Compatibility (EMC) Directive 2014/30/EU by complying with the requirements set forth in EN55032/Class B, Low Voltage (LVD) Directive 2014/35/EU by complying with the requirements set forth in EN60950-1.

Importer: SEG, 11 Capital Business Park, Borehamwood, Herts WD6 1GW.

The Vigor 2762 series is designed for PSTN, DSL and 2.4GHz / 5GHz WLAN network use in the UK & Ireland.



We DrayTek Corp. , office at No.26, Fu Shing Road, HuKou County, Hsin-Chu Industry Park, Hsinchu 300, Taiwan , R.O.C., declare under our sole responsibility that the product

Product name: ADSL2/2+ & VDSL2 Router

Model number: Vigor2762 Series

Manufacturer: DrayTek Corp.

Address: No.26, Fu Shing Road, HuKou County, Hsin-Chu Industry Park, Hsinchu 300, Taiwan , R.O.C.

is in conformity with the relevant Union harmonisation legislation:

EMC Directive 2014/30/EU, Low Voltage Directive 2014/35/EU , ErP 2009/125/EC and RoHS 2011/65/EU with reference to the following standards

Standard	Version / Issue date
EN 55032	2012+AC:2013 class B
EN 61000-3-2	2014 Class A
EN 61000-3-3	2013
EN 55024	2010+A1:2015
EN 60950-1	2006 +A11:2009 +A1:2010 +A12:2011+ A2:2013
EC No. 1275/2008	2008

Frequency Information for Europe area

2.4G WLAN	2412MHz - 2472 MHz, max. TX power: 19.98dBm *1
5G WLAN	5180MHz - 5700 MHz, max. TX power: 27.00dBm *2
	Requirements in AT/BE/BG/CZ/DZ/DK/EE/FR/DE/IS/IE/IT/EL/ES/CY/LV/LI/LT/LU/HU/MT/NL/NO/PL/PT/RO/SI/SK/TR/FI/SE/CH/UK/HR. 5150MHz-5350MHz is for indoor use only.

(*1: for 2.4G WLAN model; *2: for 5G WLAN model)

Date: 22nd June, 2017

Place: Hsinchu

Legal Signature:



Calvin Ma - President



Join the UK mailing list

Users in the UK & Ireland can sign up to our mailing list which goes out approximately 4 times per year with products news, updates, hints & tips and offers. For details, please visit www.draytek.co.uk/list

Firmware & Tools Updates

Due to the continuous evolution of DrayTek technology and emerging risks, router firmware updates may be issued. Please consult the DrayTek web site for more information on newest firmware, tools and documents: www.draytek.co.uk (For UK/Ireland)

Regional and Network Compatibility

For all models, please check that you have been supplied with a device intended for your geographic region and networks. Hardware and software varies by region, as well as local support and warranty services. To be sure of compatibility and local support, ensure that you are buying the correct product through authorized channels. The outside of the product's box will state the region compatibility (e.g. "Applied Region: UK"). If you are unsure, check with DrayTek or your supplier. The use of unofficial components (e.g. PSUs) or adapting interfaces or the use of unauthorized software/firmware may cause malfunction, product damage or personal danger and invalidates your warranty and access to support services.

Table of Contents

1. Introduction.....	1
2. Package Contents.....	2
3. Panel Explanation.....	3
3.1 Vigor 2762n	3
3.2 Vigor 2762ac	5
4. Installing your Vigor 2762 router.....	7
4.1 Wall-Mounting the Vigor 2762	8
5. Setup & Configuration.....	9
5.1 Accessing the Router Web Interface.....	9
5.2 WAN1 - ADSL and VDSL2 Connection Setup.....	12
5.2.1 PPPoE connection with FTTC VDSL2	12
5.2.2 DHCP / Static IP connection with FTTC VDSL2	16
5.2.3 PPPoA connection with ADSL / ADSL2+.....	19
5.3 WAN2 – Ethernet Connection Setup.....	20
5.3.1 Enabling the Ethernet WAN Port	21
5.3.2 PPPoE.....	23
5.3.3 Static or Dynamic IP.....	24
5.4 WAN3 / WAN4 – 3G / 4G USB Modem Setup	25
5.4.1 PPP Mode	25
5.4.2 DHCP Mode	27
6. Getting further help	28
7. Additional Feature Setup	28
8. Keep up to date with our mailing list	28
9. Firmware Updates.....	29
10. Security & Router Best Practice.....	29

1. Introduction

The Vigor2762 series is an ADSL2+ / VDSL2 router / firewall with guest network capability for fast and secure home and small office connectivity, designed for bandwidth-intensive applications such as high-definition video streaming, online gaming and Internet telephony.

Packed with advanced features, the Vigor 2762 series offers truly comprehensive DSL connectivity and security. Compatible with all UK variants of ADSL (including ADSL2+ and Annex M), VDSL2 (BT Infinity™/FTTC), the Vigor 2762 can also be used for cable-modem or fibre connections, using its GigaLAN 4 port in Ethernet WAN mode and 3G/4G cellular service using a supported USB modem.

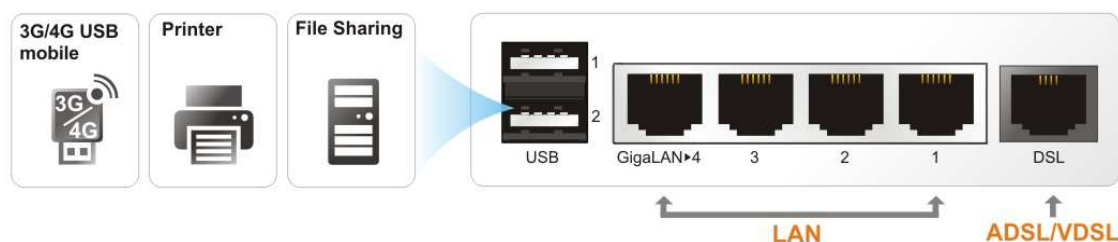

A 4-port Gigabit Ethernet switch on the LAN side provides high speed connectivity for your computers or network storage (NAS) devices and can connect a VigorAP wireless access point or network switch with 802.1Q VLAN tagging. Comprehensive security features include content filtering, web application controls and an object based firewall management system.

GlobalView Web Content Filtering allows blocking of websites based on the category they're determined to fit in, which is managed by the GlobalView servers, making it far simpler to block unwanted sites (e.g. Gambling and adult categories) with less maintenance required as new or changed site categorisations are continuously updated. A free 30-day trial is included with your new router.

Advanced IP based Quality of Service, Bandwidth Management and WAN Budget facilities make it possible to control bandwidth usage fairly on your network, prioritising important traffic such as Voice over IP over bulk downloads and making it possible to limit network segments, such as the guest network from over-using bandwidth.

The router's hardware accelerated IPSec/SSL/L2TP VPN (Virtual Private Networking) functionality can dial-out quickly and securely to an office VPN server for teleworking.

The SSL VPN server allows you to connect your computer, phone or tablet into your home network from anywhere, with access to network storage and secure Internet connectivity through the SSL VPN tunnel.

Two USB ports allow for connection of USB Printers, USB Storage (for Samba or FTP usage) for basic NAS functionality, USB Modem for Internet connectivity or a USB Temperature sensor to monitor temperatures remotely and warn if the temperature goes outside of the desired range.

2. Package Contents



DrayTek Vigor 2762 router



Quick Start Guide
(This document)

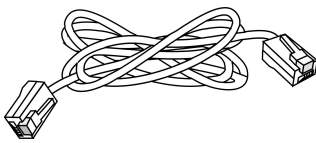

RJ-45 Cable (Ethernet)
(Connects to your PC or Switch)

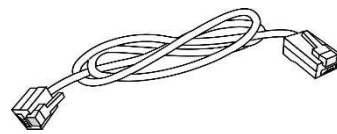

RJ-11 to RJ-11 Cable
(Connects to your DSL line)

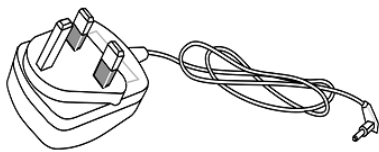

UK Power Adapter

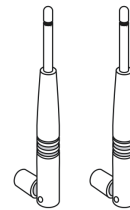





Antenna

3. Panel Explanation

3.1 Vigor 2762n





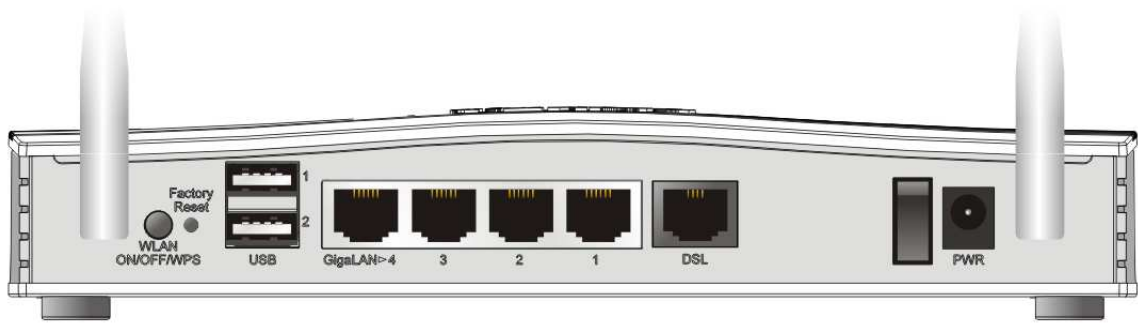



LED	Status	Explanation
 (Activity)	Blinking	The router is ready and operating normally
	Off	The router is powered off
 (Wireless LAN On/Off/WPS)	On	2.4GHz Access Point is active
	Blinking	Data is being transmitted on the router's 2.4 GHz wireless interface
	Blinking in unison with (Activity)	WPS pairing mode is active for two minutes
	Off	2.4GHz Access Point is turned off
 (USB)	On	USB device is connected and ready for use
	Blinking	Data is being transmitted over USB
 (DSL)	On	DSL connection synchronised
	Blinking (Slowly)	DSL connection not currently synchronising or not detected
	Blinking (Quickly)	DSL connection is synchronising
 (LAN1/2/3/4)	On	Ethernet LAN (RJ45) is connected
	Blinking	Data is transmitting (sending/receiving)
	Off	Ethernet LAN is disconnected



Interface	Description
Wireless LAN ON/OFF/WPS	<p>WLAN On - Press the button and release it within 2 seconds. When the wireless function is enabled, the green LED will be on</p> <p>WLAN Off - Press the button and release it within 2 seconds to turn off the WLAN function. When the wireless function is not enabled, the LED will be off</p> <p>When WPS is enabled in the router's web interface, press this button for more than 2 seconds to enable WPS pairing mode</p>
Factory Reset	<p>Restore the default settings.</p> <p>Usage: Turn on the router (ACT LED is blinking). Press gently and hold for more than 5 seconds. When the ACT LED blinks rapidly, release the button and the router will restart with its factory default configuration.</p>
USB1~USB2	<p>Connector for a USB 3G/4G modem, storage, printer or USB Thermometer.</p>
GigaLAN1~LAN4	<p>RJ-45 Gigabit Ethernet connectors for local network devices. GigaLAN4 can be configured as the Ethernet WAN port, see Section 5.3 for details</p>
DSL	<p>RJ-11 connector for ADSL or VDSL line</p>
I / O	<p>Power Switch. Turns the unit on (I) or off (O)</p>
PWR	<p>Connector for the power adapter</p>

3.2 Vigor 2762ac



LED	Status	Explanation
 (Activity)	Blinking	The router is ready and operating normally
	Off	The router is powered off
 (2.4GHz Wireless LAN On/Off/WPS)	On	2.4GHz Access Point is active
	Blinking	Data is being transmitted on the router's 2.4 GHz wireless interface
	Blinking in unison with (Activity)	WPS pairing mode is active for two minutes
	Off	2.4GHz Access Point is turned off
 (5GHZ Wireless LAN On/Off/WPS)	On	5GHz Access Point is active
	Blinking	Data is being transmitted on the router's 5GHz wireless interface
	Blinking in unison with (Activity)	WPS pairing mode is active for two minutes
	Off	5GHz Access Point is turned off
 (USB)	On	USB device is connected and ready for use
	Blinking	Data is being transmitted over USB
 (DSL)	On	DSL connection synchronised
	Blinking (Slowly)	DSL connection not currently synchronising or not detected
	Blinking (Quickly)	DSL connection is synchronising
 (LAN1/2/3/4)	On	Ethernet LAN (RJ45) is connected
	Blinking	Data is transmitting (sending/receiving)
	Off	Ethernet LAN is disconnected

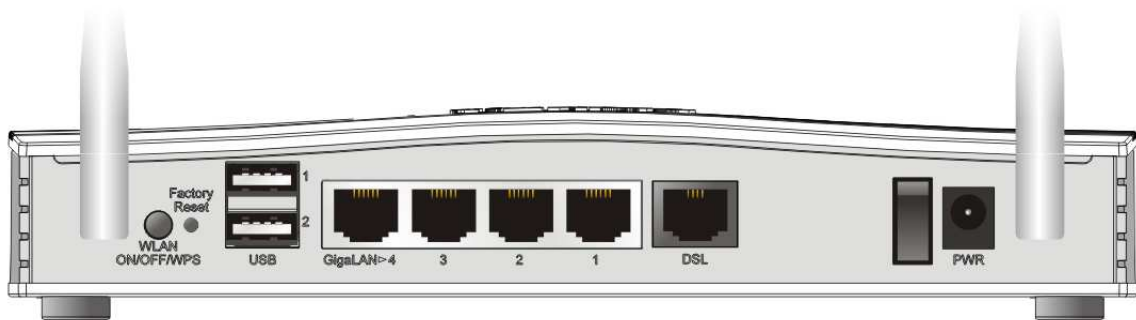

Interface	Description
Wireless LAN ON/OFF/WPS	<p>Press for less than 2 seconds to switch toggle the router's wireless interfaces:</p> <p>For example,</p> <ul style="list-style-type: none"> ● 2.4G (On) and 5G (On) - Default state. ● 2.4G (Off) and 5G (On) - press and release the button once. ● 2.4G (On) and 5G (Off) - press and release the button twice. ● 2.4G (Off) and 5G (Off) - press and release the button three times. <p>When WPS is enabled in the router's web interface, press this button for more than 2 seconds to enable WPS pairing mode.</p>
Factory Reset	<p>Restore the default settings.</p> <p>Usage: Turn on the router (ACT LED is blinking). Press gently and hold for more than 5 seconds. When the ACT LED blinks rapidly, release the button. Then the router will restart with the factory default configuration</p>
USB1-USB2	Connector for a USB 3G/4G modem, storage, printer or USB Thermometer
GigaLAN1-LAN4	RJ-45 Gigabit Ethernet connectors for local network devices. GigaLAN4 can be configured as the Ethernet WAN port, see Section 5.3 for details
DSL	RJ-11 connector for ADSL or VDSL line
I / O	Power Switch. Turns the unit on (I) or off (O)
PWR	Connector for the power adapter

4. Installing your Vigor 2762 router

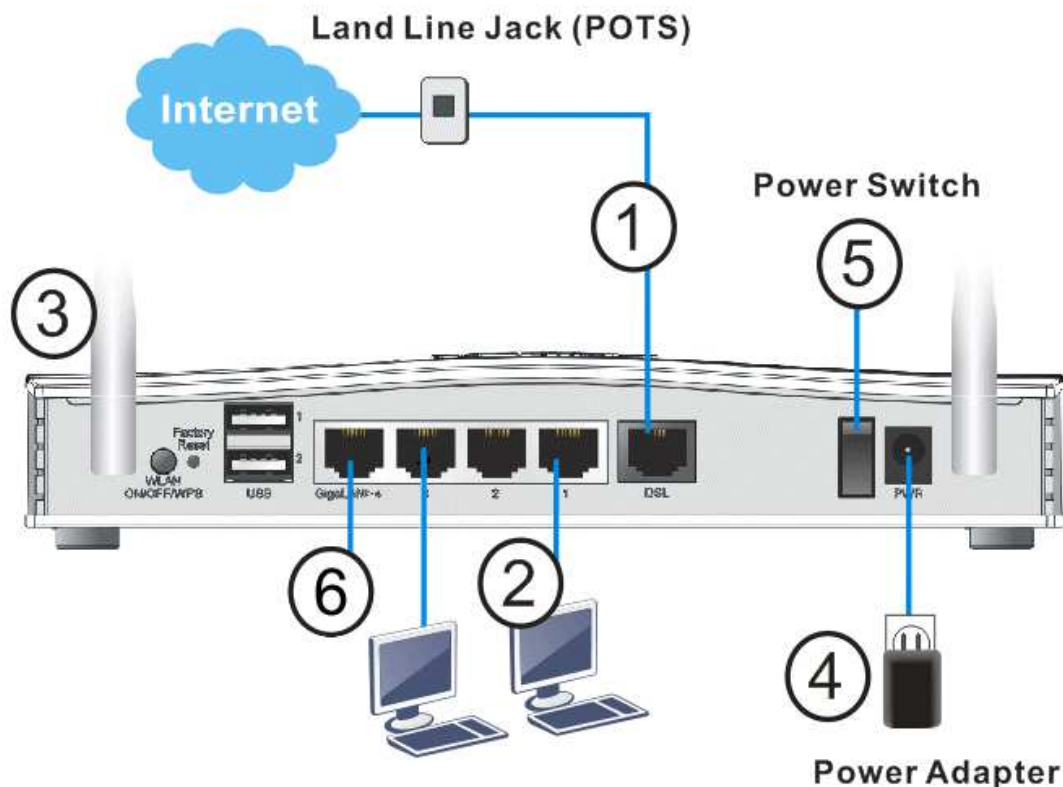

1. **ADSL/VDSL Connections:** Connect the DSL port to the Modem or DSL port of the external splitter/microfilter (not supplied) with the RJ-11 line cable. In some cases, your RJ-11 DSL socket will be built-into your phone line socket on the wall and you won't have a separate microfilter/splitter.
2. **LAN Connections:** Connect a LAN port of the router to your computer or switch.
3. **Wireless Antennas:** Connect the wireless antennas to the router
4. **Power Supply:** Connect the power adapter to the Vigor 2762's PWR socket on the rear and plug the power adapter into a suitable mains socket. Turn the Vigor 2762 on using its power switch.
5. The router will start up. After completing the system test, the ACT LED will light up and start blinking once per second to indicate that it is ready for use. For more detailed information of LED status, please refer to section 3.1 Front Panel Overview.
6. **Ethernet-based Internet Connections:** The GigaLAN4 port can be switched to operate as the Ethernet WAN port. This must be configured in the router's web interface before it can operate in this mode - Section 5.3 of Quick Start Guide details how to do that.
With the GigaLAN4 port configured for Ethernet WAN mode, connect the cable Modem/DSL Modem/Media Converter to the WAN port of the router with Ethernet cable (RJ-45).

4.1 Wall-Mounting the Vigor 2762

DrayTek Vigor 2762 series routers have keyhole type mounting slots on the underside to hang the router on, using screws attached to a wall or other surface.

1. A template is provided in the Vigor router packaging box to enable you to space the screws correctly on the wall
2. Place the template on the wall in the desired position and drill holes through the cardboard template at the marked points
3. Fit screws into the wall using the appropriate type of wall plug

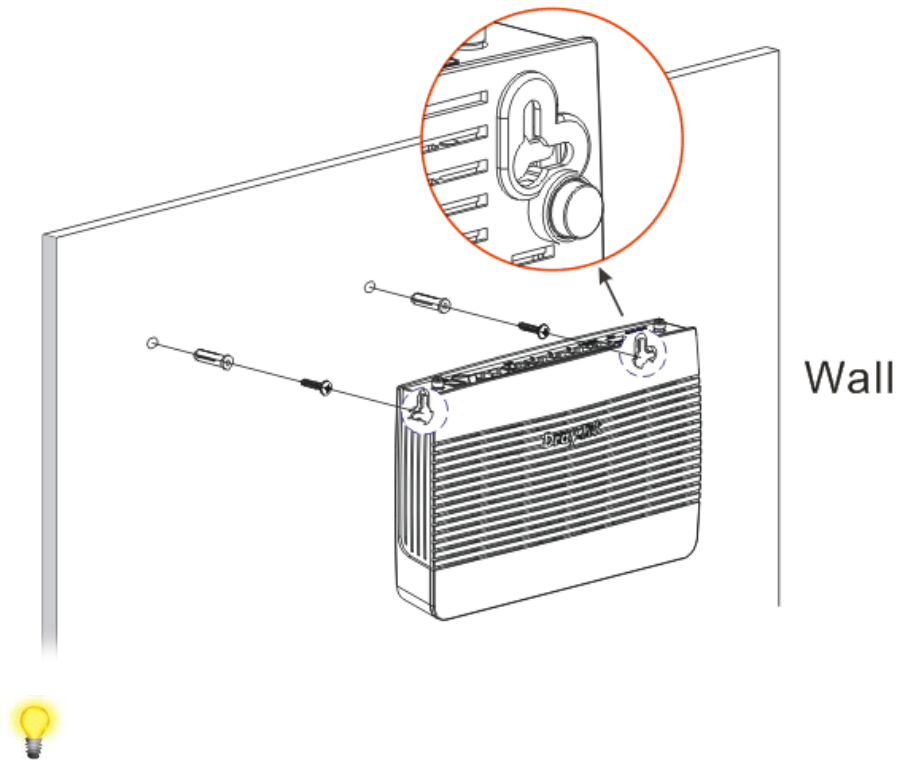

Note

Recommended drill bit diameter is 6.5mm (1/4").

4. With the screws installed, the router can be slotted into place

5. Setup & Configuration

This section provides examples of how to initially access the router and configure internet access for the most common types of Internet connection in the UK. If the instructions in this quick start guide do not allow you to get online with your ISP or type of Internet connection, there are additional guides available on in the Product Knowledgebase.

5.1 Accessing the Router Web Interface



Note

To access the router, your PC will need to either get its IP address using DHCP or have an IP address in the 192.168.1.x range. For details on how to change this, please refer to the “Trouble Shooting” section in the User Guide.

Open a web browser on your PC and type **https://192.168.1.1**.

The https:// prefix ensures that your connection is encrypted using SSL so that your session data cannot be intercepted. Without that prefix, your data passes in clear text.

You may get a warning from your browser (IE, Chrome, Edge, Safari etc.) about your server (the router) having an invalid certificate. Your browser will demand further confirmation or exception before allowing access. The warnings will look something like these examples.

This is from Mozilla Firefox:

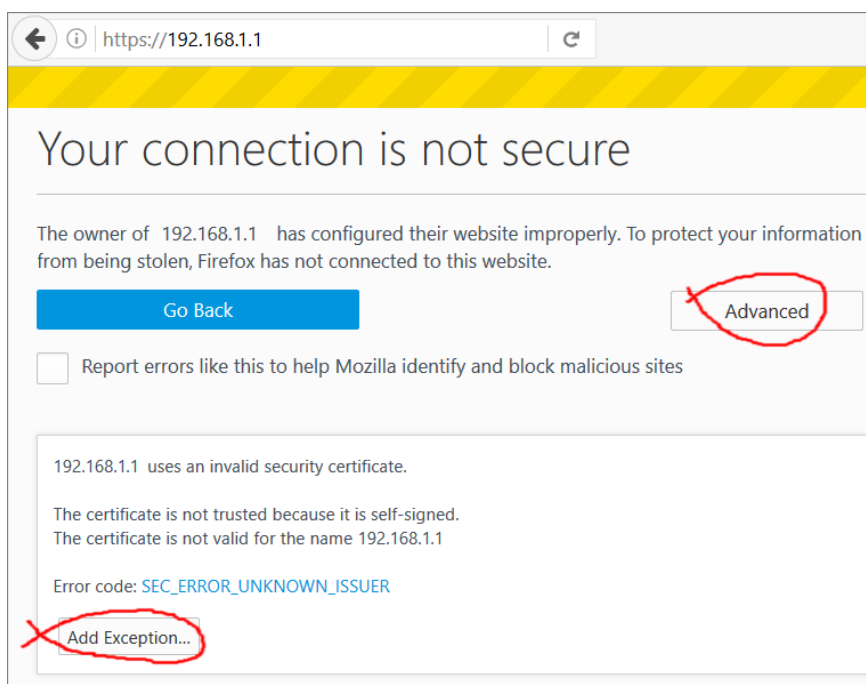

This is from Microsoft Edge:

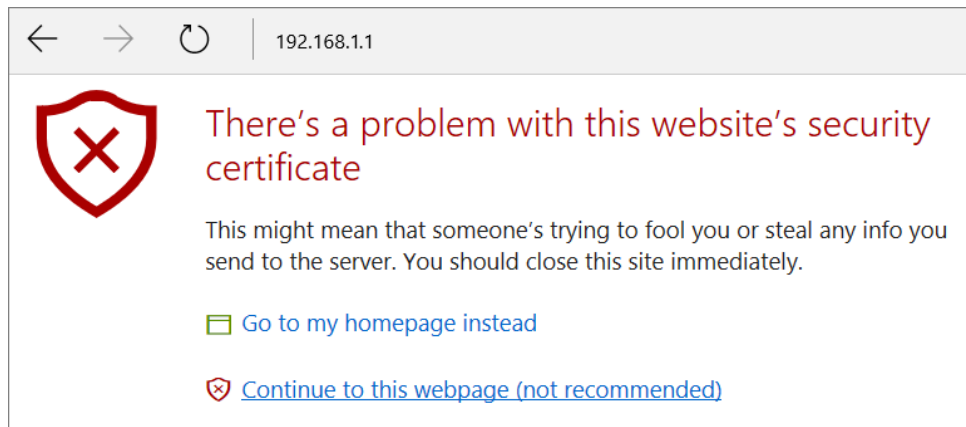

Most other browsers will present equivalent warnings. In each case, following the prompts/links will allow you to access the router's web interface. It is still encrypted with SSL/TLS.



Note

This warning appears because the router's default certificate is 'self-signed' rather than issued to you by a certificate authority who has verified your identity. A self-signed certificate means that you cannot verify the identity of the server, but as it's your own local router, that shouldn't be an issue - your connection is still encrypted.

The router login prompt will display ask for username and password.

The default login details are:

Username: admin
Password: admin





Note

If you cannot access the web interface, please go to the “Trouble Shooting” section in the User Guide to determine the cause of and solve your problem.

Upon successful login, the router will display the **Dashboard**, which shows a summary of the router model, WAN status, front panel port status and other information:

DrayTek Vigor2762 Series

Auto Logout | IR6

Dashboard

Dashboard
Wizards
Online Status

WAN
LAN
Hotspot Web Portal
Routing
NAT
Hardware Acceleration
Firewall
Objects Setting
CSM
Bandwidth Management
Applications
VPN and Remote Access
Certificate Management
Wireless LAN (2.4 GHz)
Wireless LAN (5 GHz)
SSL VPN
USB Application
System Maintenance
Diagnostics

Central Management
AP
External Devices

Support Area
Product Registration

All Rights Reserved.

System Information

Model Name	Vigor2762ac	System Up Time	27:19:31
Router Name	DrayTek	Current Time	2018 Feb 1 Thu 15:11:30
Firmware Version	3.8.8_RC2	Build Date/Time	Jan 25 2018 16:55:15
DSL Version	07-07-09-05-01-07	LAN MAC Address	00-1D-AA-65-33-60

Quick Access

System Status
Dynamic DNS
TR-069
IM/2P Block
Schedule
SysLog / Mail Alert
RADIUS
Firewall Object Setting
Data Flow Monitor

IPv4 Internet Access

	Line / Mode	IP Address	MAC Address	Up Time
WAN1	VDSL2 / PPPoE	Disconnected	00-1D-AA-65-33-61	00:00:00
WAN2	Ethernet / Static IP	198.51.100.154	00-1D-AA-65-33-62	27:19:07
WAN3	USB / ---	Disconnected	00-1D-AA-65-33-63	00:00:00

Interface

DSL	Connected : Down Stream : 79999Kbps / Up Stream : 19998Kbps
WAN	Connected : 1, WAN1 WAN2 WAN3
LAN	Connected : 0, Port1 Port2 Port3 Port4
WLAN	Connected : 0
WLAN5G	Connected : 0
USB	Connected : 1, USB 1 0, USB 2

Security

VPN	Connected : 0 Remote Dial-in User / LAN to LAN
DoS	Attack Detected :

System Resource

Current Status :	CPU Usage: <div style="width: 5%;"></div> 5%
	Memory Usage: <div style="width: 92%;"></div> 92%



Note

We recommend configuring a secure password when first logging in to the router’s administration interface.

The router’s administration password can be changed from **[System Maintenance] > [Administrator Password]**

5.2 WAN1 - ADSL and VDSL2 Connection Setup

The WAN1 interface of the Vigor 2762 router can connect to either an ADSL / ADSL2+ connection or a VDSL2 connection.

If your Internet connection uses VDSL2 and your ISP has supplied you with a Username and Password to connect to the Internet, go to section

5.2.1 PPPoE connection with FTTC VDSL2

If your Internet connection uses VDSL2 and your ISP does not supply or require a Username and Password to connect to the Internet, go to section

5.2.2 DHCP / Static IP connection with FTTC VDSL2

If your Internet connection uses ADSL or ADSL2+ and your ISP has supplied you with a Username and Password to connect to the Internet, go to section

5.2.3 PPPoA connection with ADSL / ADSL2+

5.2.1 PPPoE connection with FTTC VDSL2

1. Go to [WAN] > [General Setup] and click on the WAN1 link:

DrayTek Vigor2762 Series

WAN >> General Setup

Index	Enable	Physical Mode/Type	Active Mode	
WAN1	V	ADSL/-	Always On	V
WAN2	V	Ethernet/Auto negotiation	Failover(WAN1)	V
WAN3	V	USB/-	Failover(WAN2)	V

OK

2. On the settings page:

WAN >> General Setup

WAN 1

Enable:	<input type="text" value="Yes"/>	
Display Name:	<input type="text"/>	
Physical Mode:	VDSL2	
DSL Mode:	<input type="text" value="Auto"/>	
DSL Modem Code:	<input type="text" value="AnnexA_779517_773F01"/>	
Line Speed(Kbps):		
DownLink	<input type="text" value="0"/>	
UpLink	<input type="text" value="0"/>	
Active Mode:	<input type="text" value="Always On"/>	
VLAN Tag insertion	Customer	Service
ADSL	<input type="text" value="Disable"/> Tag value <input type="text" value="0"/> (0~4095) Priority <input type="text" value="0"/> (0~7)	
VDSL2	<input type="text" value="Disable"/> Tag value <input type="text" value="0"/> (0~4095) Priority <input type="text" value="0"/> (0~7)	<input type="text" value="Enable"/> Tag value <input type="text" value="101"/> (0~4095) Priority <input type="text" value="0"/> (0~7)

- Set the Enable option to Yes to activate the WAN1 connection
- Set the Active Mode to Always On
- **Enable the Service - VLAN Tag insertion**
- Set the Tag value setting to **101**
- DSL mode can be set to “VDSL2 only” but this is not required



Note

Please note that this value is correct for ISPs that operate over the Openreach VDSL2 network, if your ISP operates on a different VDSL2 network, this tag value may differ; please check with your ISP or the DrayTek UK Knowledgebase for ISP specific guides.

Click **OK** on that page to apply the changes.

3. Go to [WAN] > [Internet Access]

Firstly set the WAN1 Access Mode to PPPoE / PPPoA, then click the **Details Page** button to proceed:

WAN >> Internet Access

Index	Physical Mode	Access Mode	
WAN1	ADSL / VDSL2	PPPoE / PPPoA	Details Page
WAN2	Ethernet	None	Details Page
WAN3	USB	None	Details Page

4. On the PPPoE / PPPoA settings tab:

Select the **Enable** radio button at the top of the page to ensure that the PPPoE interface is enabled.

Input the username into the **Username** field and password in the **Password** field, as required. The Service Name does not need to be specified.

If your ISP has provided a static IP address, that can be specified by setting the **Fixed IP** setting to **Yes** and entering the IP in the **Fixed IP Address** field.

WAN >> Internet Access

WAN 1

PPPoE / PPPoA	MPoA / Static or Dynamic IP	IPv6
<input checked="" type="radio"/> Enable <input type="radio"/> Disable		
Modem Settings (for ADSL only)		
Multi-PVC channel	Channel 1	
VPI	0	
VCI	38	
Encapsulating Type	VC MUX	
Protocol	PPPoA	
Modulation	Multimode	
ISP Access Setup		
Service Name ¹		
Username	A123456@HG00.btclick.c	
Password	
<input type="checkbox"/> Fallback account		
Fallback Username		
Fallback Password		

Click **OK** on this page to apply the changes and the router will then prompt to restart. Click the OK button to restart the router.

- Once the router has restarted, the [Online Status] > [Physical Connection] page will display the VDSL information and PPP connection status, if the WAN1 section shows an IP address, it has connected to the internet successfully:

Auto Logout ▾ IPv6

Dashboard
Quick Start Wizard
Online Status
Physical Connection
Virtual WAN

WAN
LAN
NAT
Firewall
User Management
Objects Setting
CSM
Bandwidth Management
Applications
VPN and Remote Access
Certificate Management
Wireless LAN
SSL VPN
USB Application
System Maintenance
Diagnostics
External Devices

Support Area
Product Registration

Online Status

Physical Connection System Uptime: 0:8:44

	IPv4	IPv6		
LAN Status	Primary DNS: 194.72.0.98		Secondary DNS: 213.120.234.26	
IP Address	TX Packets	RX Packets		
192.168.1.1	0	0		

WAN 1 Status >> Drop PPPoA

Enable	Line	Name	Mode	Up Time		
Yes	VDSL2		PPPoE	0:07:41		
IP	GW IP	TX Packets	TX Rate(Bps)	RX Packets	RX Rate(Bps)	
217.34.6.35	217.42.145.215	224580	805	339568	963	

WAN 2 Status

Enable	Line	Name	Mode	Up Time		
Yes	Ethernet		---	00:00:00		
IP	GW IP	TX Packets	TX Rate(Bps)	RX Packets	RX Rate(Bps)	
---	---	0	0	0	0	

WAN 3 Status

Enable	Line	Name	Mode	Up Time	Signal
Yes	USB		---	00:00:00	-
IP	GW IP	TX Packets	TX Rate(Bps)	RX Packets	RX Rate(Bps)
---	---	0	0	0	0

VDSL2 Information (VDSL2 Firmware Version: 05-04-08-00-00-06)

Profile	State	UP Speed	Down Speed	SNR Upstream	SNR Downstream
17A	SHOWTIME	20000 (Kbps)	80000 (Kbps)	15 (0.1dB)	6 (0.1dB)



Note

If the WAN 1 IP address displayed begins with 172.16.x.x, it's possible that the ISP has not accepted the supplied Username and Password for the Internet connection.

Check that the ISP Access Setup - Username and Password match the details supplied by your ISP.

5.2.2 DHCP / Static IP connection with FTTC VDSL2

1. Go to [WAN] > [General Setup] and click on the WAN1 link:

The screenshot shows the DrayTek Vigor2762 Series web interface. The top navigation bar includes the DrayTek logo, the model name 'Vigor2762 Series', and several utility icons. On the left, there is a sidebar menu with options like 'Auto Logout', 'IR6', 'Dashboard', 'Wizards', 'Online Status', and a 'WAN' section containing 'General Setup' (highlighted), 'Internet Access', 'Multi-PVC/VLAN', 'WAN Budget', and 'LAN'. The main content area is titled 'WAN >> General Setup' and contains a table with the following data:

Index	Enable	Physical Mode/Type	Active Mode	
WAN1	V	ADSL/-	Always On	V
WAN2	V	Ethernet/Auto negotiation	Failover(WAN1)	V
WAN3	V	USB/-	Failover(WAN2)	V

Below the table is an 'OK' button.

2. On the settings page:

WAN >> General Setup

WAN 1

Enable:	Yes ▾	
Display Name:	<input type="text"/>	
Physical Mode:	VDSL2	
DSL Mode:	Auto ▾	
DSL Modem Code:	AnnexA_779517_773F01 ▾	
Line Speed(Kbps):		
DownLink	<input type="text" value="0"/>	
UpLink	<input type="text" value="0"/>	
Active Mode:	Always On ▾	
VLAN Tag insertion	Customer	Service
ADSL	Disable ▾ Tag value <input type="text" value="0"/> Priority <input type="text" value="0"/> (0~4095) (0~7)	
VDSL2	Disable ▾ Tag value <input type="text" value="0"/> Priority <input type="text" value="0"/> (0~4095) (0~7)	Enable ▾ Tag value <input type="text" value="101"/> Priority <input type="text" value="0"/> (0~4095) (0~7)

- Set the Enable option to Yes to activate the WAN1 connection
- Set the Active Mode to Always On
- **Enable the Service - VLAN Tag insertion**
- Set the Tag value setting to 101
- DSL mode can be set to “VDSL2 only” but this is not required



Note

Please note that this value is correct for ISPs that operate over the Openreach VDSL2 network, if your ISP operates on a different VDSL2 network, this tag value may differ; please check with your ISP or the DrayTek UK Knowledgebase for ISP specific guides.

Click **OK** on that page to apply the changes.

3. Go to **[WAN] > [Internet Access]**

Firstly set the WAN1 Access Mode to **MPoA / Static or Dynamic IP**, then click the **Details Page** button to proceed:

Auto Logout ▾

Dashboard
Wizards
Online Status

WAN
General Setup
Internet Access
Multi-PVC/VLAN
WAN Budget
LAN

WAN >> Internet Access

Internet Access

Index	Physical Mode	Access Mode	
WAN1	ADSL / VDSL2	MPoA / Static or Dynamic IP	Details Page
WAN2	Ethernet	None	Details Page
WAN3	USB	None	Details Page

4. In the MPoA / Static or Dynamic IP settings:

Select the **Enable** option and select **Obtain an IP address automatically** which will obtain an IP from the ISP using DHCP.

If your ISP has provided a static IP range, with a Network address and a Subnet Mask, specify that with the **Specify an IP address** option.

WAN 1

Enable Disable

Modem Settings (for ADSL only)
 Multi-PVC channel: Channel 2
 Encapsulation: 1483 Bridged IP LLC
 VPI: 0
 VCI: 101
 Modulation: Multimode

WAN Connection Detection
 Mode: ARP Detect

WAN IP Network Settings WAN IP Alias
 Obtain an IP address automatically
 Specify an IP address

Router Name: Vigor
 Domain Name:
 DHCP Client Identifier
 Username:
 Password:
 IP Address:
 Subnet Mask:
 Gateway IP Address:

OK Cancel

Click **OK** on this page to apply the changes and the router will then prompt to restart. Click the OK button to restart the router.

- Once the router has restarted, the **[Online Status] > [Physical Connection]** page will display the VDSL information and DHCP connection status, if the WAN1 section shows an IP address, it has connected to the internet successfully:

DrayTek Vigor2860 Series

Auto Logout IPv6

Dashboard
Quick Start Wizard
Online Status
Physical Connection
Virtual WAN

WAN
LAN
NAT
Firewall
User Management
Objects Setting
CSM
Bandwidth Management
Applications
VPN and Remote Access
Certificate Management
Wireless LAN
SSL VPN
USB Application
System Maintenance
Diagnostics
External Devices

Support Area
Product Registration

Online Status

Physical Connection System Uptime: 0:8:44

IPv4		IPv6	
LAN Status	Primary DNS: 194.72.0.98	Secondary DNS: 213.120.234.26	
IP Address	TX Packets	RX Packets	
192.168.1.1	0	0	

WAN 1 Status >> Release

Enable	Line	Name	Mode	Up Time		
Yes	VDSL2		DHCP Client	0:06:58		
IP	GW IP	TX Packets	TX Rate(Bps)	RX Packets	RX Rate(Bps)	
217.34.6.35	217.42.145.215	224580	805	339568	963	

WAN 2 Status

Enable	Line	Name	Mode	Up Time		
Yes	Ethernet		---	00:00:00		
IP	GW IP	TX Packets	TX Rate(Bps)	RX Packets	RX Rate(Bps)	
---	---	0	0	0	0	

WAN 3 Status

Enable	Line	Name	Mode	Up Time	Signal
Yes	USB		---	00:00:00	-
IP	GW IP	TX Packets	TX Rate(Bps)	RX Packets	RX Rate(Bps)
---	---	0	0	0	0

VDSL2 Information (VDSL2 Firmware Version: 05-04-08-00-00-06)

Profile	State	UP Speed	Down Speed	SNR Upstream	SNR Downstream
17A	SHOWTIME	20000 (Kbps)	80000 (Kbps)	15 (0.1dB)	6 (0.1dB)

5.2.3 PPPoA connection with ADSL / ADSL2+

1. Go to [WAN] > [Internet Access]

Firstly set the WAN1 Access Mode to PPPoE / PPPoA, then click the **Details Page** button to proceed:

WAN >> Internet Access

Index	Physical Mode	Access Mode	
WAN1	ADSL / VDSL2	PPPoE / PPPoA	Details Page
WAN2	Ethernet	None	Details Page
WAN3	USB	None	Details Page

2. On the PPPoE / PPPoA settings tab:

The details for the **VPI** and **VCI** settings for ADSL should be correct for UK usage, with **0** and **38** being the defaults. In most cases, it will not be necessary to change these. The **Modulation** setting can be left on its default of Multimode which will auto-detect the correct ADSL type to use.

Select the **Enable** radio button at the top of the page to ensure that the PPPoE interface is enabled.

Input the username into the **Username** field and password in the **Password** field, as required.

The Service Name does not need to be specified.

If your ISP has provided a static IP address, that can be specified by setting the **Fixed IP** setting to **Yes** and entering the IP in the **Fixed IP Address** field.

WAN >> Internet Access

WAN 1

Enable Disable

Modem Settings (for ADSL only)

Multi-PVC channel: Channel 1

VPI: 0

VCI: 38

Encapsulating Type: VC MUX

Protocol: PPPoA

Modulation: Multimode

ISP Access Setup

Service Name¹: []

Username: A123456@HG00.btclick.c

Password: []

Fallback account

Fallback Username: []

Fallback Password: []

Click **OK** on this page to apply the changes and the router will then prompt to restart. Click the OK button to restart the router.

- Once the router has restarted, the [Online Status] > [Physical Connection] page will display the ADSL information and PPP connection status, if the WAN1 section shows an IP address, it has connected to the internet successfully:

Auto Logout IPv6

Dashboard
Quick Start Wizard
Online Status
Physical Connection
Virtual WAN

WAN
LAN
NAT
Firewall
User Management
Objects Setting
CSM
Bandwidth Management
Applications
VPN and Remote Access
Certificate Management
Wireless LAN
SSL VPN
USB Application
System Maintenance
Diagnostics
External Devices

Support Area
Product Registration

Online Status

Physical Connection System Uptime: 0:8:44

IPv4		IPv6			
LAN Status		Primary DNS: 194.72.0.98		Secondary DNS: 213.120.234.26	
IP Address	TX Packets	RX Packets			
192.168.1.1	0	0			
WAN 1 Status >> Drop PPPoA					
Enable	Line	Name	Mode	Up Time	
Yes	VDSL2		PPPoE	0:07:41	
IP	GW IP	TX Packets	TX Rate(Bps)	RX Packets	RX Rate(Bps)
217.34.6.35	217.42.145.215	224580	805	339568	963
WAN 2 Status					
Enable	Line	Name	Mode	Up Time	
Yes	Ethernet		---	00:00:00	
IP	GW IP	TX Packets	TX Rate(Bps)	RX Packets	RX Rate(Bps)
---	---	0	0	0	0
WAN 3 Status					
Enable	Line	Name	Mode	Up Time	Signal
Yes	USB		---	00:00:00	-
IP	GW IP	TX Packets	TX Rate(Bps)	RX Packets	RX Rate(Bps)
---	---	0	0	0	0
VDSL2 Information (VDSL2 Firmware Version: 05-04-08-00-00-06)					
Profile	State	UP Speed	Down Speed	SNR Upstream	SNR Downstream
17A	SHOWTIME	20000 (Kbps)	80000 (Kbps)	15 (0.1dB)	6 (0.1dB)



Note

If the WAN 1 IP address displayed begins with 172.16.x.x, it's possible that the ISP has not accepted the supplied Username and Password for the Internet connection.

Check that the ISP Access Setup - Username and Password match the details supplied by your ISP.

5.3 WAN2 – Ethernet Connection Setup

The WAN2 interface of the Vigor 2762 router can connect to a modem such as the Vigor 130 VDSL2 to Ethernet modem, an ISP supplied router or another network with an Internet connection.

The Ethernet WAN port is shared with the GigaLAN4 port and must be configured to operate in WAN mode as shown in section 5.3.1 Enabling the Ethernet WAN Port

If you are using a modem and your ISP has supplied you with a Username and Password to connect to the Internet, go to section 5.3.2 PPPoE

If the router is connected to a modem and the ISP does not supply or require a Username and Password to connect to the Internet, or you are connecting the WAN2 connection to another router or network go to section 5.3.3 Static or Dynamic IP

5.3.1 Enabling the Ethernet WAN Port

The Vigor 2762 series router uses the GigaLAN4 port to connect to an Ethernet based Internet connection. In its default state, the GigaLAN4 port operates as a standard LAN port and the WAN2 (Ethernet WAN) options cannot be selected in the router's web interface.

To enable the router's Ethernet WAN port on GigaLAN4 instead of LAN mode:

1. Go to [WAN] > [General Setup] and click WAN2



2. In its default state, the Enable option is set to No, which allows the GigaLAN4 port to be used as a standard LAN port.

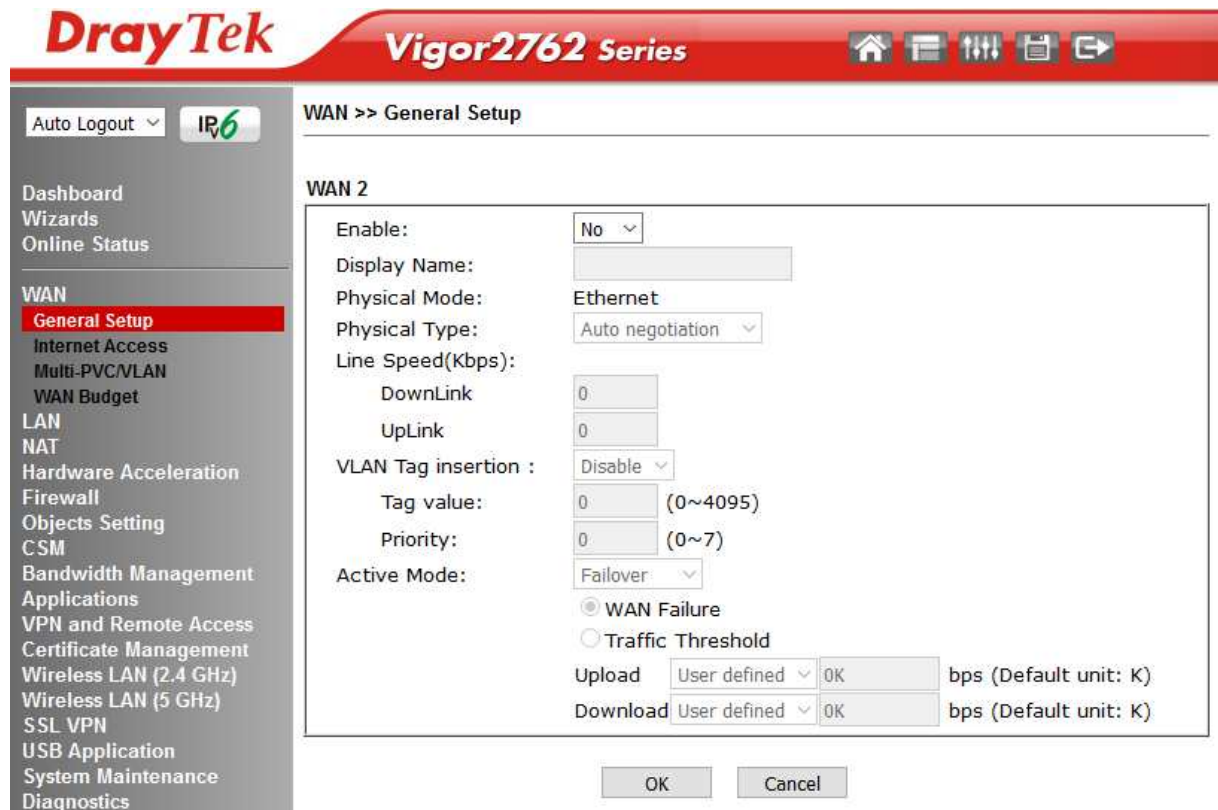

- Set the **Enable** option for WAN2 to **Yes**, this enables the other options on this page. Set the Active Mode to **Always On** to make the Ethernet port the active Internet connection.

DrayTek Vigor2762 Series

Auto Logout | IPv6

Dashboard
Wizards
Online Status

WAN
General Setup
Internet Access
Multi-PVC/VLAN
WAN Budget
LAN
NAT
Hardware Acceleration
Firewall
Objects Setting
CSM
Bandwidth Management
Applications
VPN and Remote Access
Certificate Management
Wireless LAN (2.4 GHz)

WAN >> General Setup

WAN 2

Enable: Yes ▾
 Display Name:
 Physical Mode: Ethernet
 Physical Type: Auto negotiation ▾
 Line Speed(Kbps):
 DownLink:
 UpLink:
 VLAN Tag insertion : Disable ▾
 Tag value: (0~4095)
 Priority: (0~7)
 Active Mode: Always On ▾

OK Cancel

- Click OK to apply the change and the router will prompt to restart. Click OK to restart the router.

System Maintenance >> Reboot System

Reboot System

Do you want to reboot your router ?

Using current configuration
 Using factory default configuration

OK

Once the router has restarted, the WAN2 - Ethernet WAN interface can be configured on the router, as shown in the following two sections.



Note

To reconfigure the GigaLAN4 port for LAN use, go to **[WAN] > [General Setup] > [WAN2]** and set the **Enable** option to **No**. Once the router has been restarted to apply the change, the port will operate in LAN mode.

5.3.2 PPPoE

This connection method will typically be used with a modem such as the Vigor 130 VDSL2 modem, which passes through the PPPoE connection from the ISP to the router.

1. Go to [WAN] > [Internet Access]

Firstly set the WAN2 Access Mode to PPPoE, then click the **Details Page** button to proceed:

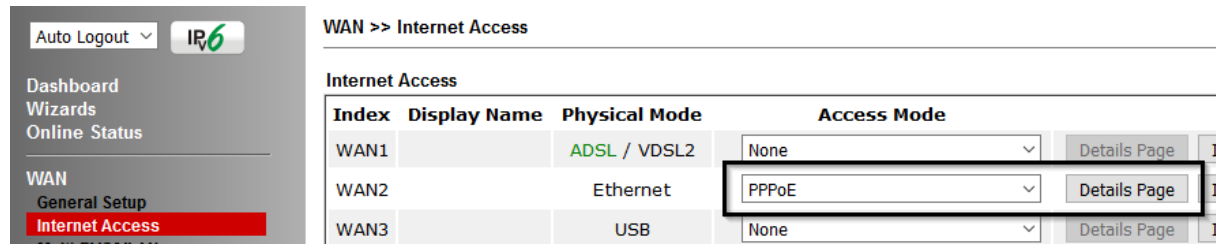

2. In the PPPoE settings tab:

Select the **Enable** radio button at the top of the page to ensure that the PPPoE interface is enabled.

Input the username into the **Username** field and password in the **Password** field, as required. The Service Name does not need to be specified.

If your ISP has provided a static IP address, that can be specified by setting the **Fixed IP** setting to **Yes** and entering the IP in the **Fixed IP Address** field.

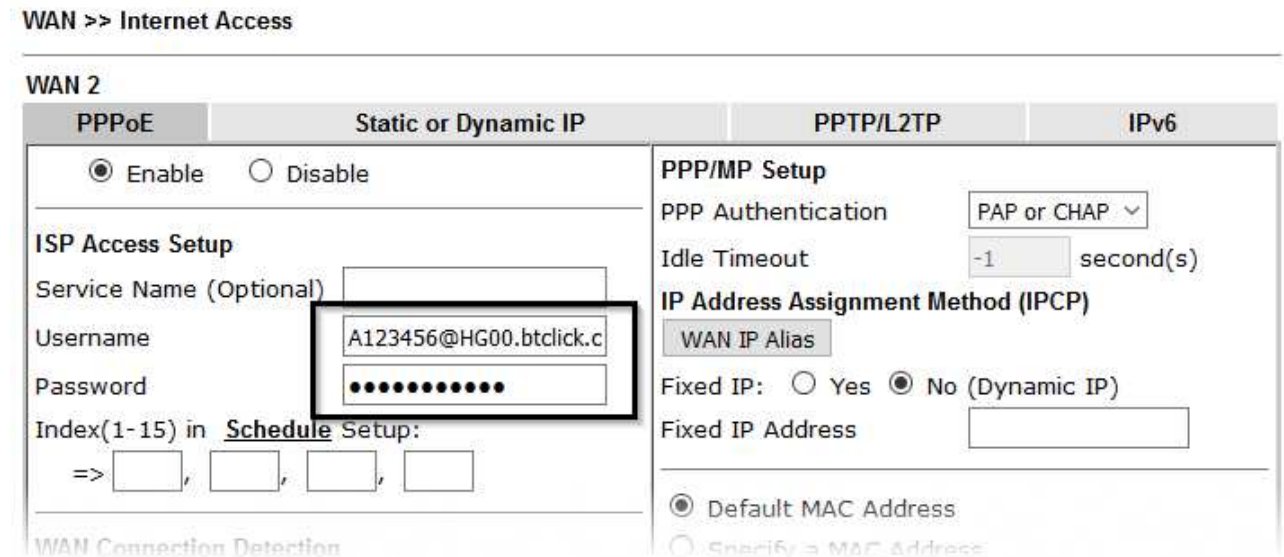

Click **OK** on that page to save the settings and the router will then prompt to restart, allow it to restart to properly apply the changes.

Once the router has restarted, log back into the web interface and select [Online Status] > [Physical connection], if it has connected, the relevant WAN Interface status text will be in green along with an IP address which indicates that the connection is active and ready for use.

5.3.3 Static or Dynamic IP

1. Go to [WAN] > [Internet Access]

Firstly set the WAN2 Access Mode to Static or Dynamic IP, then click the Details Page button to proceed:

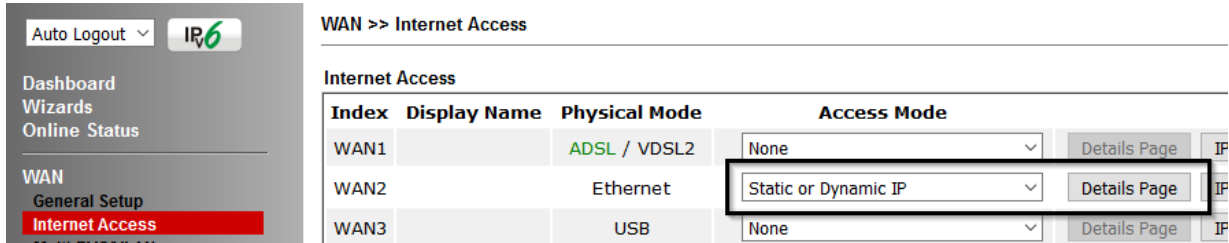

2. In the Static or Dynamic IP settings:

Select the **Enable** option and select **Obtain an IP address automatically** which will obtain an IP from the ISP with DHCP.

If your ISP has provided a static IP range, with a Network address and a Subnet Mask, specify that with the **Specify an IP address** option.

WAN >> Internet Access

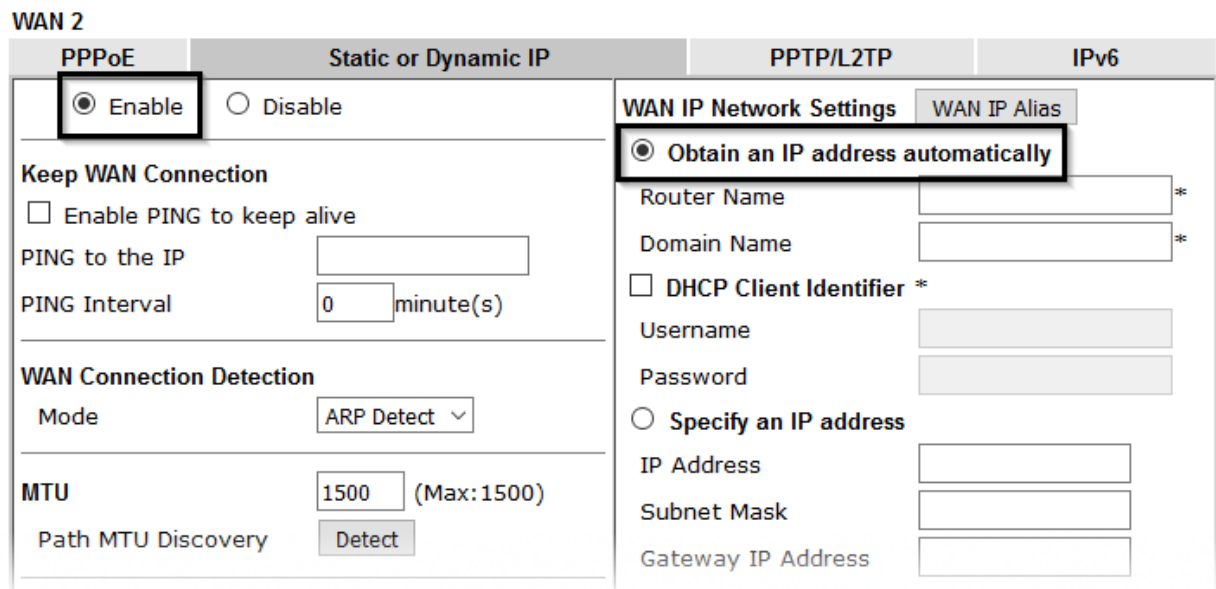

Click **OK** on this page to apply the changes and the router will then prompt to restart. Click to restart the router.

Once the router has restarted, log back into the web interface and select [Online Status] > [Physical connection], if it has connected, the relevant WAN Interface status text will be in green along with an IP address which indicates that the connection is active and ready for use.

5.4 WAN3 / WAN4 – 3G / 4G USB Modem Setup

The 3G / 4G USB modem facility can be used either as a primary Internet connection or as a backup that will only activate when other WAN interfaces are offline. It allows a supported USB modem to provide internet access through the router.

The list of supported modems can be found under:
[USB Application] > [Modem Support List]

or on the DrayTek UK site:

<https://www.draytek.co.uk/support/guides/usb-3g-4g-modem-support-list>

There are two USB modem connection modes available:

PPP mode is used where the modem provides a dial-up interface and would typically require software to perform dialing and provide status information and diagnostics when used with a PC.

DHCP mode is used where the modem operates as a virtual network adapter / router and will usually have diagnostics and usage information shown in a web interface.

When configuring the 3G / 4G modem, the router will require the correct **APN** (Access Point Name) details and a username and password with some ISPs. If those details are not set, the mobile network may reject the connection attempts of the router, which will result in the router showing no signal / no IP address.

5.4.1 PPP Mode

To set up the USB WAN for PPP mode, go to [WAN] > [Internet Access]
Select **3G/4G USB Modem (PPP mode)** from the drop-down box

Click the **Details Page** button to continue:

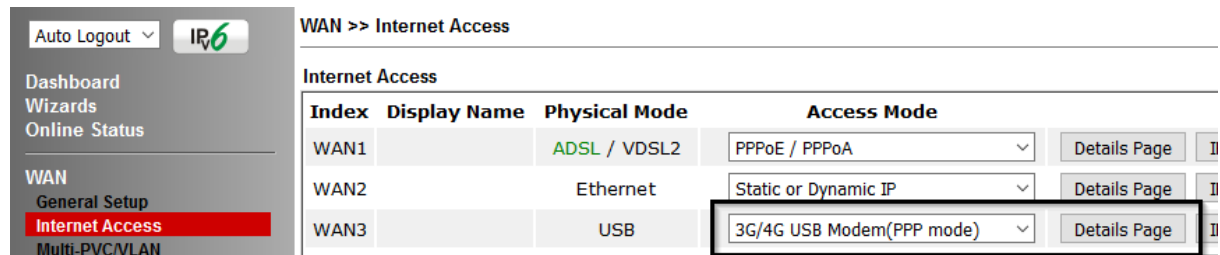

The screenshot shows the router's configuration interface. On the left is a navigation menu with 'Internet Access' highlighted. The main content area is titled 'WAN >> Internet Access' and contains a table of WAN interfaces. The table has columns for Index, Display Name, Physical Mode, and Access Mode. WAN3 is selected, and its Access Mode is set to '3G/4G USB Modem(PPP mode)'. A 'Details Page' button is visible next to it.

Index	Display Name	Physical Mode	Access Mode	
WAN1		ADSL / VDSL2	PPPoE / PPPoA	Details Page
WAN2		Ethernet	Static or Dynamic IP	Details Page
WAN3		USB	3G/4G USB Modem(PPP mode)	Details Page

In the USB WAN settings, select the **Enable** option to enable the WAN interface.

The Modem String values typically do not need to be changed.

Enter the **PPP Username** and **PPP Password** if your ISP requires these to authenticate.

Enter a **SIM PIN** code only if your SIM card has a PIN set on it, otherwise leave this blank.

WAN 3

3G/4G USB Modem(PPP mode)	<input checked="" type="radio"/> Enable <input type="radio"/> Disable	
SIM PIN code	<input type="text"/>	
Modem Initial String	<input type="text" value="AT&FE0V1X1&D2&C1S0=0"/> <small>(Default:AT&FE0V1X1&D2&C1S0=0)</small>	
APN Name	<input type="text"/>	<input type="button" value="Apply"/>
Modem Initial String2	<input type="text" value="AT"/>	
Modem Dial String	<input type="text" value="ATDT*99#"/> <small>(Default:ATDT*99#, CDMA:ATDT#777, TD-SCDMA:ATDT*98*1#)</small>	
Service Name	<input type="text"/>	(Optional)
PPP Username	<input type="text"/>	(Optional)
PPP Password	<input type="text"/>	(Optional)
PPP Authentication	<input type="text" value="PAP or CHAP"/>	

To set the **APN Name**, enter the APN required by the SIM card / network into the APN Name field and click the **Apply** button:

3G/4G USB Modem(PPP mode)	<input checked="" type="radio"/> Enable <input type="radio"/> Disable	
SIM PIN code	<input type="text"/>	
Modem Initial String	<input type="text" value="AT&FE0V1X1&D2&C1S0=0"/> <small>(Default:AT&FE0V1X1&D2&C1S0=0)</small>	
APN Name	<input type="text" value="exampleAPN"/>	<input type="button" value="Apply"/>
Modem Initial String2	<input type="text" value="AT"/>	
Modem Dial String	<input type="text" value="ATDT*99#"/>	

This will move the APN Name into the **Modem Initial String** to indicate that it has been saved.

3G/4G USB Modem(PPP mode)	<input checked="" type="radio"/> Enable <input type="radio"/> Disable	
SIM PIN code	<input type="text"/>	
Modem Initial String	<input type="text" value="APN:exampleAPN"/> <small>(Default:AT&FE0V1X1&D2&C1S0=0)</small>	
APN Name	<input type="text" value="exampleAPN"/>	<input type="button" value="Apply"/>
Modem Initial String2	<input type="text" value="AT"/>	
Modem Dial String	<input type="text" value="ATDT*99#"/>	

Click **OK** to save and apply the changes.

If the modem is detected successfully, the WAN interface should be able to connect. Status information can be viewed on the **[Online Status] > [Physical Connection]** section as WAN3. If there is a successful connection, the WAN interface text will show in green and will show an IP address.

5.4.2 DHCP Mode

To set up the USB WAN for DHCP mode, go to **[WAN] > [Internet Access]**
Select **3G/4G USB Modem (DHCP mode)** from the drop-down box
Click the **Details Page** button to continue:

Index	Display Name	Physical Mode	Access Mode	
WAN1		ADSL / VDSL2	PPPoE / PPPoA	Details Page
WAN2		Ethernet	Static or Dynamic IP	Details Page
WAN3		USB	3G/4G USB Modem(DHCP mode)	Details Page

In the USB WAN settings, select the **Enable** option to enable the WAN interface.

Enter a **SIM PIN** code only if your SIM card has a PIN set on it, otherwise leave this blank.

Network Mode defaults to **4G/3G/2G** which will auto-select the network type to connect to and will use whichever mode the base station recommends. Setting this to a specific mode will force that connection type, for instance “4G Only” will connect using 4G specifically

The APN Name will typically not need to be set with a USB modem that uses DHCP mode, however if the modem cannot connect then enter the APN for the SIM card used in the modem.

WAN >> Internet Access

WAN 3

<input checked="" type="radio"/> Enable <input type="radio"/> Disable	Authentication <input type="text" value="PAP or CHAP"/>
SIM PIN code <input type="text"/>	Username <input type="text"/> (Optional)
Network Mode <input type="text" value="4G/3G/2G"/> (Default: 4G/3G/2G)	Password <input type="text"/> (Optional)
APN Name <input type="text" value="exampleAPN"/>	
LTE hardware version ---	
WAN Connection Detection	
Mode <input type="text" value="ARP Detect"/>	
MTU <input type="text" value="1500"/> (Default: 1500)	
Path MTU Discovery <input type="text" value="Choose IP"/>	

Click **OK** to save and apply the changes.

If the modem is detected successfully, the WAN interface should be able to connect. Status information can be viewed on the **[Online Status] > [Physical Connection]** section as **WAN3**. If there is a successful connection, the WAN interface text will show in green and will show an IP address.

6. Getting further help

If the router does not appear to be operating correctly or you cannot get online to the Internet, please visit our web site (www.draytek.co.uk) for further troubleshooting advice or to contact our support technicians. Always have your serial number to hand.

Users in the UK/Ireland using qualifying products should visit for support options including email support, telephone support, our help knowledgebase and access to the UK user support forums.

If you are **outside** of the UK/Ireland, please contact your own local supplier, email to support@draytek.com or visit www.draytek.com/support

For warranty service, in the first instance, please contact the support services, as listed above, for help in diagnosing or eliminating the problem or issue. The support department can arrange repair or service if then deemed necessary.

The standard Vigor 2762 series warranty is 'Return to base' (RTB) unless you have VigorCare which provides enhanced services (see www.draytek.co.uk/vigorcare).

You should keep your proof of purchase (original invoice) safely in case warranty or other service is ever required.

7. Additional Feature Setup

This is a quick setup guide to get you online with your new router. Your Vigor 2762 series router is capable of very much more and has a plethora of other features.

These are covered in the main user manual, which is available on the Downloads page:

<https://www.draytek.co.uk/support/downloads>

The online knowledgebase has additional information on how to configure the router's Internet connectivity and more advanced features:

<https://www.draytek.co.uk/support/product-knowledgebase>

8. Keep up to date with our mailing list

Now that you have your DrayTek product, you should keep up to date with product updates (firmware), security advisories and other product news, advice or special offers. Users in the UK/Ireland can subscribe to our mailing list. For details and to subscribe, please visit

In other countries or regions, please contact your local distributor/supplier for local options.

9. Firmware Updates

It is strongly recommended that you keep your router firmware up to date with the latest version in order to have all of the latest security and feature improvements.

Always obtain firmware from official sources, i.e. (for UK/Ireland users).

There are two firmware file types:

.all - upgrade retaining all previous settings

.rst - upgrade and reset to factory default

It is recommended to take a configuration backup prior to upgrading the firmware.

10. Security & Router Best Practice

Your router is the gateway to an entire business network and data. Even the best security equipment requires correct usage in order to ensure that its features are effective.

There are many simple practices that every router user should adopt to help reduce the risk to their network or business as well as some very common and simple mistakes that people habitually make - simple mistakes which could then be exploited by others.

We've produced our free guide "**Router Best Practice**" which contains essential information for anyone installing, configuring or using a broadband router or wireless LAN.

Available to download: <https://www.draytek.co.uk/best>