

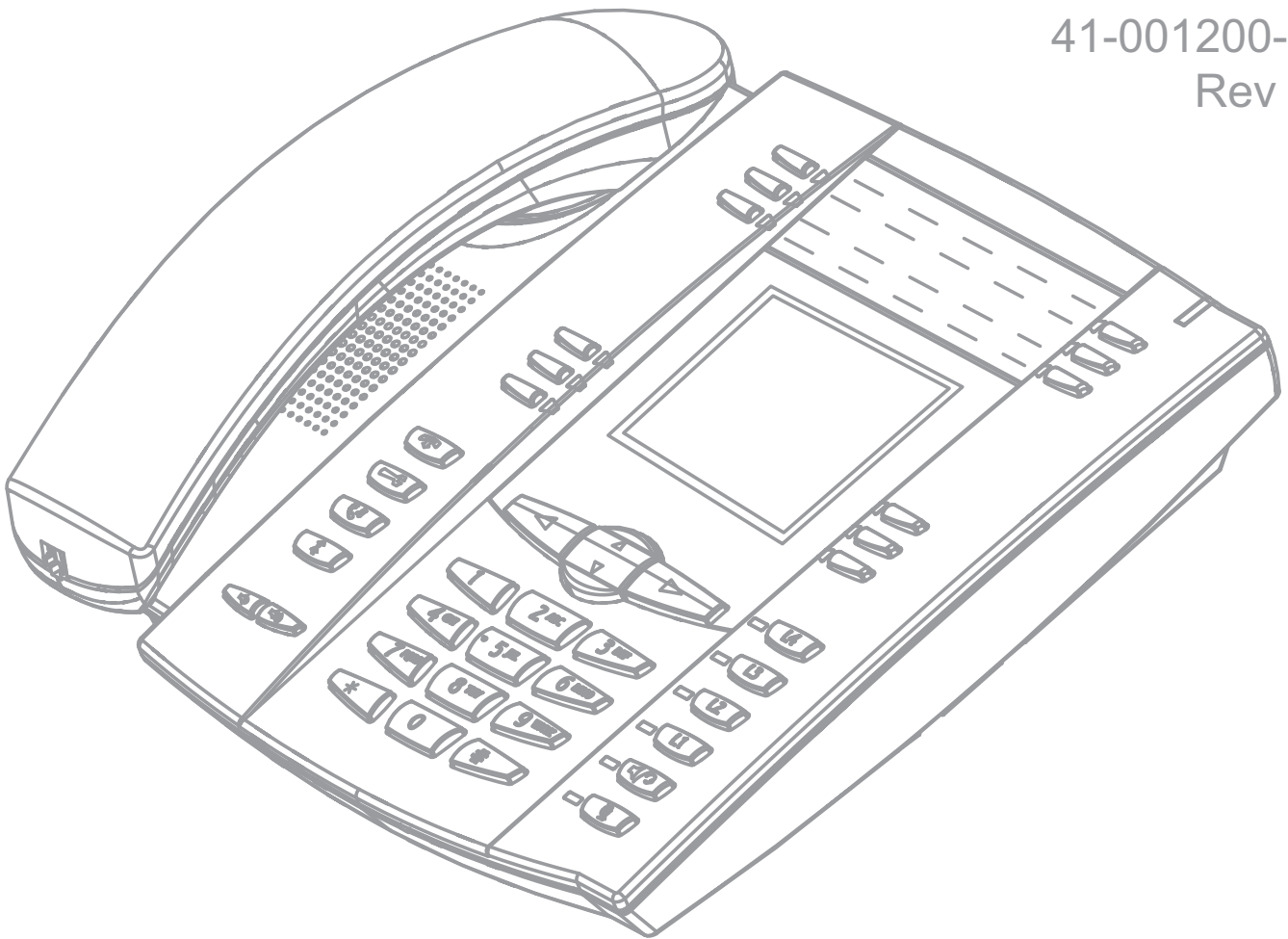

6755i IP Phone

User Guide
Release 2.5

41-001200-20
Rev 00



Aastra Telecom will not accept liability for any damages and/or long distance charges, which result from unauthorized and/or unlawful use. While every effort has been made to ensure accuracy, Aastra Telecom will not be liable for technical or editorial errors or omissions contained within this documentation. The information contained in this documentation is subject to change without notice.



Copyright 2008 Aastra Telecom. www.aastratelecom.com
All Rights Reserved.

Software License Agreement

Aastra Telecom Inc., hereinafter known as "Seller", grants to Customer a personal, worldwide, non-transferable, non-sublicenseable and non-exclusive, restricted use license to use Software in object form solely with the Equipment for which the Software was intended. This Product may integrate programs, licensed to Aastra by third party Suppliers, for distribution under the terms of this agreement. These programs are confidential and proprietary, and are protected as such by copyright law as unpublished works and by international treaties to the fullest extent under the applicable law of the jurisdiction of the Customer. In addition, these confidential and proprietary programs are works conforming to the requirements of Section 401 of title 17 of the United States Code. Customer shall not disclose to any third party such confidential and proprietary programs and information and shall not export licensed Software to any country except in accordance with United States Export laws and restrictions.

Customer agrees to not reverse engineer, decompile, disassemble or display Software furnished in object code form. Customer shall not modify, copy, reproduce, distribute, transcribe, translate or reduce to electronic medium or machine readable form or language, derive source code without the express written consent of the Seller and its Suppliers, or disseminate or otherwise disclose the Software to third parties. All Software furnished hereunder (whether or not part of firmware), including all copies thereof, are and shall remain the property of Seller and its Suppliers and are subject to the terms and conditions of this agreement. All rights reserved.

Customer's use of this software shall be deemed to reflect Customer's agreement to abide by the terms and conditions contained herein. Removal or modification of trademarks, copyright notices, logos, etc., or the use of Software on any Equipment other than that for which it is intended, or any other material breach of this Agreement, shall automatically terminate this license. If this Agreement is terminated for breach, Customer shall immediately discontinue use and destroy or return to Seller all licensed software and other confidential or proprietary information of Seller. In no event shall Seller or its suppliers or licensors be liable for any damages whatsoever (including without limitation, damages for loss of business profits, business interruption, loss of business information, other pecuniary loss, or consequential damages) arising out of the use of or inability to use the software, even if Seller has been advised of the possibility of such damages.

Table of Contents

Software License Agreement	iii
Table of Contents	v
About this Guide	1
Documentation	1
Introduction	2
Phone Features	2
Requirements	2
Installation and Setup	3
Getting Started	4
Plugging in and Starting the Phone	4
Network Connected/Network Disconnected	7
Idle Screen	8
IP Phone Keys and Key Descriptions	12
Key Descriptions	12
Methods for Customizing Your Phone	15
Phone Options via the IP Phone UI	15
Phone Options via the Aastra Web UI	18
Phone Status	22
Phone Status via IP Phone UI	22
Finding Your Phone's IP Address	23
Phone Status via the Aastra Web UI	24
Customizing Your Phone	27
Ring Tones and Tone Sets	27
Contrast Level	30
Backlight	31
Live Dialpad*	33
Set Audio	34
Time and Date	37
Language	44
User Password	52
Resetting a User Password	54
Restarting your phone	55
Phone Lock	56
Defining an Emergency Dial Plan	58

Table of Contents

Line Keys, Programmable Keys, and Softkeys	60
Multiple Line and Call Appearances	60
Softkeys and Programmable Keys	61
State-Based Softkeys (Bottom Keys only)	64
Line Key	67
Speeddial Key	71
Editing Speeddial Keys	78
"Do not Disturb" (DND) Key	82
Busy Lamp Field (BLF) Key	84
BLF List Key	87
Automatic Call Distribution (ACD) Key (for Sylanro Servers)	90
Directed Call Pickup/Group Call Pickup Keys (for Sylanro Servers)	95
XML Key	101
Flash Key	108
Sprecode Key	110
Park/Pickup Keys	112
Last Call Return (lcr) Key (Sylanro Servers only)	119
Call Forward Key	121
BLF/Xfer	123
Speeddial/Xfer	126
Speeddial/Conf	129
Services Key	132
Directory Key	135
Callers List Key	137
Intercom Key	139
Phone Lock Key	141
Paging Key (Sends the RTP Stream)	143
None Key	147
Empty Key	149
Deleting a Key	151
Making Calls	152
Dialing a Number	152
Pre-dialing a Number	153
Using Handsfree Speakerphone	153

Table of Contents

Using a Headset	154
Using Intercom	155
Redial	157
Mute	158
Receiving Calls	159
Answering an Incoming Call	159
Sending an Incoming Call to Voicemail	160
Handling Calls	161
Placing a Call on Hold	161
Transferring Calls	163
Conferencing Calls	165
Ending Calls	171
Managing Calls	172
Directory List	172
Callers List	183
Account Configuration (DND and Call Forwarding)	188
Missed Calls Indicator	209
Voicemail	210
Additional Features	211
Star Codes	211
Suppress DTMF Playback	211
Display DTMF Digits	213
Enable/Disable Call Waiting	215
Play Call Waiting Tone	217
Stuttered Dial Tone	218
XML Beep Support	219
Status Scroll Delay	220
Incoming Call Interrupts Dialing	221
Switch UI Focus to Ringing Line	223
Preferred Line and Preferred Line Timeout	224
Goodbye Key Cancels Incoming Calls	226
UPnP Mapping Lines (for remote phones)	228
Message Waiting Indicator	230
Incoming Intercom Call Features	231

Table of Contents

Using Redial Key for “Last Number Redial”	234
Group RTP Paging (receives RTP streams)	235
Use LLDP ELIN	237
Shared Call Appearance (SCA) Call Bridging	238
Available Features Enabled by Administrators	241
Outgoing Intercom Calls	241
Missed Call Summary Subscription	241
Customizable Callers List Key and Services Key	242
Autodial (Hotline and Warmline)	242
Centralized Conferencing	242
Answer and Ignore Softkeys for XML Applications	243
XML Softkey for Special Characters in XML Applications	243
Playing a WAV File On Your Phone	244
Using the Keypad During Active XML Applications	244
Key Redirection	245
XML Applications and Off-Hook Interaction	246
XML Override for a Locked Phone	246
RTP Recording and Simultaneous Playing	246
“Hold” Feature Enhancement (for Broadsoft Servers)	247
Authentication Support for HTTP/HTTPS Download Methods Used with Broadsoft Client Management System (CMS)	247
Diverting Calls from Your Phone	248
Display of Call Destination Information	249
Model M670i and M675i Expansion Modules	250
Using the Expansion Modules	252
Troubleshooting Solutions	255
Limited Warranty	261
Appendix A - Time Zone Codes	A-1
Index	Index-1

About this Guide

This guide explains how to use the basic features of your new 6755i phone. Not all features listed are available by default. Contact your system or network Administrator to find out which features and services are available to you on your system.

Your System Administrator has the ability to customize some features on this phone. For information on more advanced settings and configurations, Administrators should refer to the *Aastra SIP IP Phone Administrator Guide*.

Documentation

- ***Aastra 6755i SIP IP Phone Installation Guide*** – Contains installation and set-up instructions, general features and functions, and basic options list customization. This Installation Guide is included in the box with your phone.
- ***Aastra 6755i SIP IP Phone User Guide*** – Describes the most commonly used features and functions for an end user. This User Guide can be downloaded from www.aastratelecom.com.
- ***Aastra SIP IP Phone Administrator Guide*** – Contains advanced Administrator information and procedures for setting up the 6755i IP Phone on a network. This Administrator Guide is intended for the System Administrator and can be downloaded from www.aastratelecom.com.

Introduction

This 6755i IP telephone has all the features of a regular business phone, allowing you to make and receive calls, transfer, conference and more. The 6755i IP telephone provides communications over an IP Network using the SIP IP telephony protocol.

Phone Features

- 8 line graphical LCD screen (144 x 75 pixels) with white backlight
- 12 programmable keys
 - 6 Top keys: Programmable hard keys
 - 6 Bottom keys: Programmable state-based softkeys
- Press-and-hold speeddial key configuration feature
- 4 call appearance lines with LEDs
- Supports up to 9 call lines
- Full-duplex speakerphone for handsfree calls
- Headset mode support (via handset jack)
- Built-in-two-port, 10/100 Ethernet switch - lets you share a connection with your computer.
- Inline power support (based on 802.3af standard) which eliminates power adapters.
- AC power adapter (included)
- Enhanced busy lamp fields*
- Set paging*

* Availability of feature dependant on your phone system or service provider

Requirements

The 6755i IP Phone requires the following environment:

- SIP-based IP PBX system or network installed and running with a SIP account created for the 6755i IP phone.
- Access to a Trivial File Transfer Protocol (TFTP), File Transfer Protocol (FTP), Hypertext Transfer Protocol (HTTP) server, or Hyper Text Transfer Protocol over Secure Sockets Layer (SSL) (HTTPS).
- Ethernet/Fast Ethernet LAN (10/100 Mb)
- Category 5/5e straight through cabling

- Power source

For Ethernet networks that supply in-line power to the phone (IEEE 802.3af):

- For power, use the Ethernet cable (supplied) to connect from the phone directly to the network for power. (No 48v AC power adapter required.)

For Ethernet networks that DO NOT supply power to the phone:

- For power, use the 48V AC Power Adapter (included) to connect from the DC power port on the phone to a power source.

or

- (optional) - For power, use a Power over Ethernet (PoE) power injector or a PoE switch. A PoE power injector is available as an optional accessory from Aastra Telecom. Contact your Administrator for more information.

Installation and Setup

If your System Administrator has not already setup your 6755i phone, please refer to the *Aastra 6755i Installation Guide* for basic installation and physical setup information. For more advanced administration and configuration information, System Administrators should refer to the *Aastra SIP IP Phone Administrator Guide*.

Getting Started

The 6755i must be set up and be configured prior to its first use. This section describes phone behavior and start up screens you may see when the phone is first plugged in, or when it is restarted.

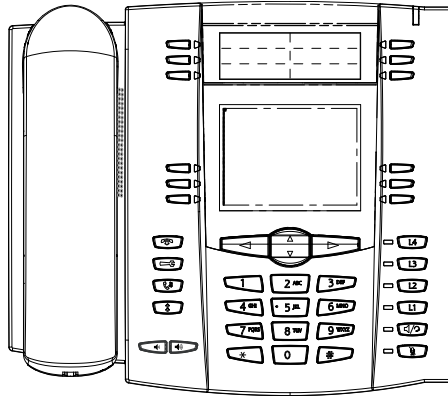

Plugging in and Starting the Phone

The 6755i automatically begins the start up sequence as soon as it is connected. The phone goes through this process the first time you plug in your phone and every time you restart your phone.

The phone displays the following startup screens.

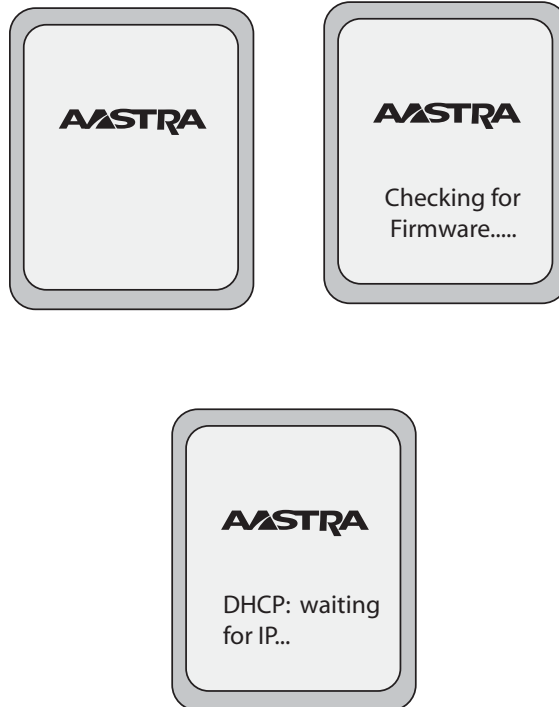

The 6755i phone then checks settings and looks for new configuration and firmware updates for the phone from a server. If a new update is found, the phone displays the message “**Updating Configuration**”. This may take a few moments while the phone downloads the latest updates.

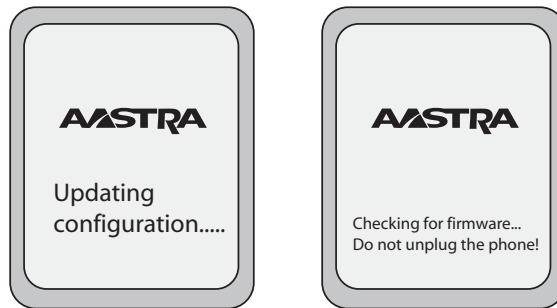

Note: New updates to your phone can be automatically scheduled from the server. This is set up on the phone system by your System Administrator and should be scheduled during non-business hours or slow call periods.



Important! Do not unplug or remove power to the phone while it is checking or installing firmware and configuration information.

If language packs were loaded to your phone by your System Administrator, the following screen displays during startup.



When the configuration update is complete, the phone displays the following screens and then displays the Idle screen.

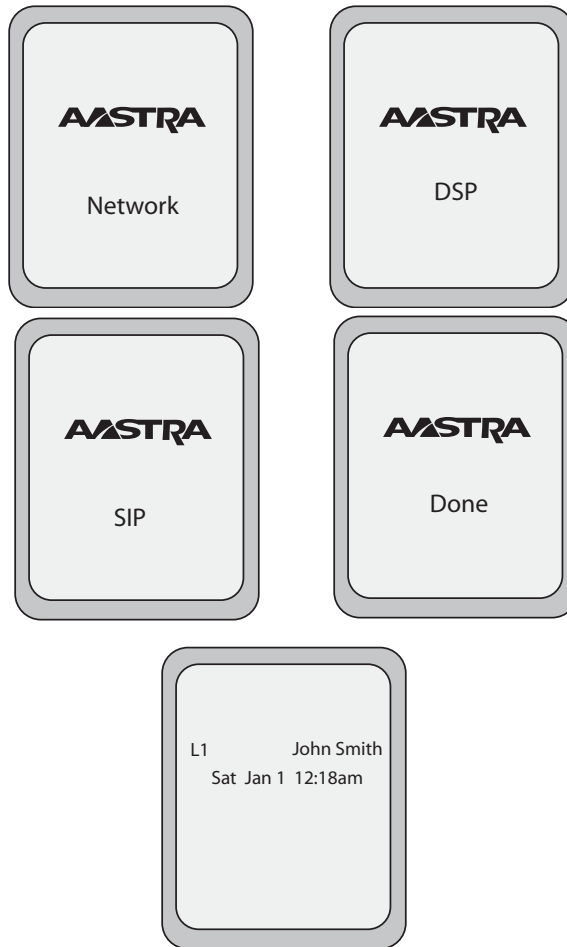

Idle Screen

Network Connected/Network Disconnected

If your phone is successful when connecting to the network the following screen displays before changing to the Idle screen.

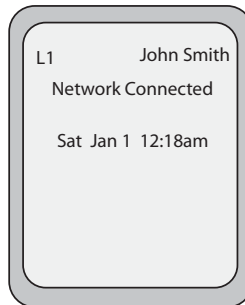

If your phone did not successfully connect to the network, the "**Network Disconnected**" prompt appears on the display and the telephone status light turns on.

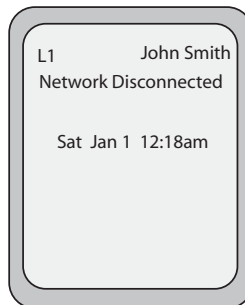

Check that the cables are tightly connected to the phone and to the wall jack. The phone should automatically detect when it is reconnected and displays the "**Network Connected**" prompt for a few seconds. However, if changes have been made to your phone's network settings, you may need to restart your phone.

For more information about connecting your phone, see the *Aastra 6755i IP Phone Installation Guide*, the section "**Connecting to the Network and to Power**".

Check with your system or network Administrator for assistance.



Note: If the phone displays "No Service" you can still use the phone but it is not registered with the Registrar. For more information about registering your phone, see your System Administrator.

Idle Screen

When the phone has successfully updated the configuration and connected to the network, the phone displays the **Idle State** screen. The idle screen is shown whenever your phone is not in use.

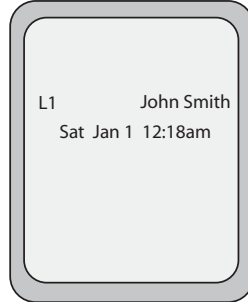

Note: Your System Administrator sets up your SIP screen name, line number, and any other administrative features required. If your name does not display on the screen, contact your System Administrator.

The **Idle State** screen lists your name (SIP screen name) and day, date, and time. In the above screen, the "L1" indicates John Smith is configured on Line 1.

By default, the top programmable keys 1 through 4 are configured for Services, Directory, Callers List, and Intercom, respectively. You can configure the 6 top programmable keys with up to 6 functions, and the 6 bottom softkeys with up to 20 functions as required.

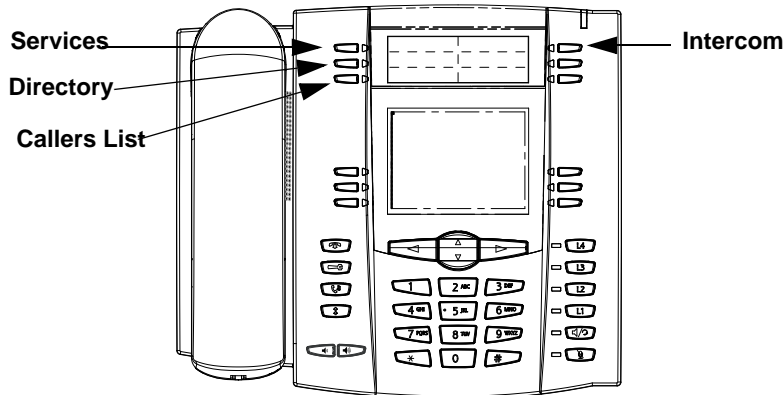

Reference

For more information about configuring the top programmable keys and the bottom softkeys, see [“Softkeys and Programmable Keys”](#) on page 61.

For more information about using the Services, Directory, Callers List, Intercom, Dial, Conference, and Transfer keys, see the following sections:

- [“Making Calls”](#) on page 152.
- [“Handling Calls”](#) on page 161.
- [“Managing Calls”](#) on page 172.

Idle Screen With Softkeys/Programmable Keys Configured

If you or your Administrator have configured softkey functions on your phone, the labels for those functions display on the screen. Programmable key functions (top keys) do not display on the LCD. For example, in the following illustration, **Home** and **Office** were configured as speeddial keys on the bottom set of softkeys and **Do Not Disturb** (DND) was configured on the top set of programmable keys.

 **Note:** The top programmable key descriptions do not display on the LCD. You can write the function assigned to the programmable key using the label provided for the phone.

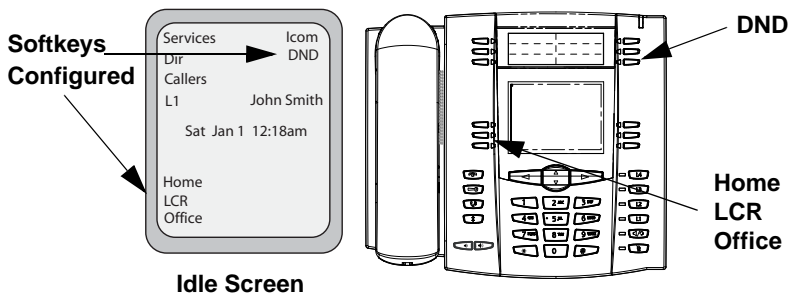

Idle Screen with Voicemail Messages

The envelope icon  displays on the Idle State screen only if you have new messages waiting. The number next to the envelope indicates how many new messages you have.

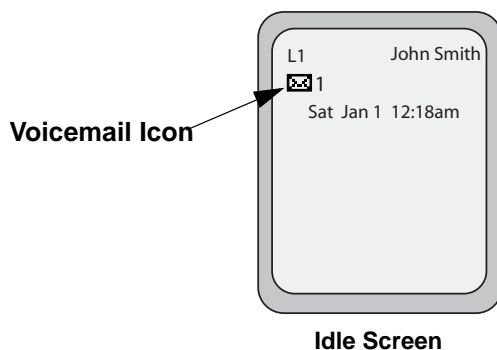

To access your voicemail messages, use the star codes for your system if a voicemail softkey has not been configured on your phone. For more information on your system's star codes, please refer to the documentation for the voicemail system you are using.

Screen Display After Picking Up the Handset

When you pickup the handset, the screen displays as follows:

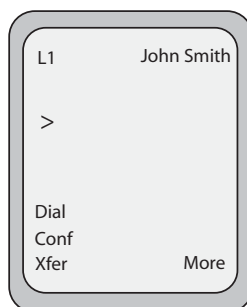

This screen displays the following keys located on the bottom left of the screen:

- Dial
- Conf (Conference)
- Xfer (Transfer)

These keys are static and cannot be changed.

A **More** softkey also displays at the bottom right of the screen if you have configured softkeys.

For example, in the illustration below, the 6755i has several bottom softkeys configured on the idle screen. A **"More"** key displays for you to view additional softkeys on another screen. Also, if you pick up the handset, a **"More"** displays for you to view additional softkeys. You can press the **More** softkey to toggle between the first and second screens to display all configured softkeys.

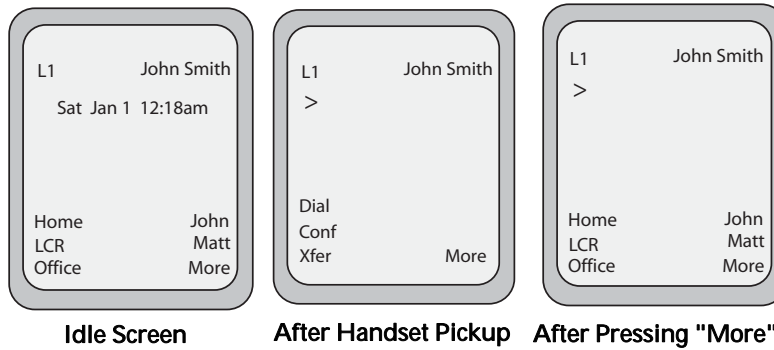

Note: The bottom set of 6 softkeys map to the current state-based configurable softkeys.



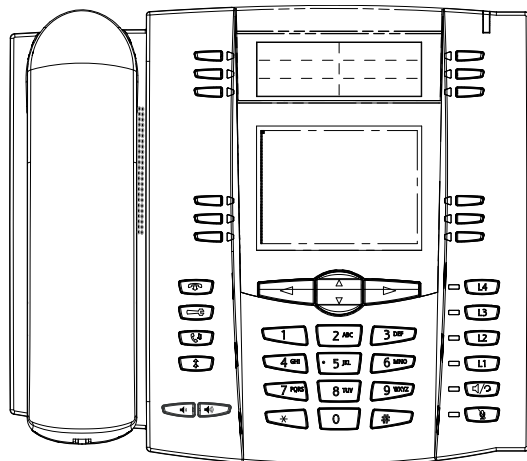

IP Phone Keys and Key Descriptions





The following sections describe the various 6755i phone key functions, and how they help you make and manage your calls and caller information.



Key Descriptions

The following table identifies the keys on the key panel of your 6755i IP phone that you can use for handling calls.

Keys	Key Description
	Goodbye key - Ends an active call. The Goodbye key also exits an open list, such as the Options List, without saving changes.
	Options key - Accesses options to customize your phone. Your System Administrator may have already customized some of your settings. Check with your System Administrator before changing the Administrator-only options.
	Hold key - Places an active call on hold. To retrieve a held call, press the call appearance button beside the light that is flashing.
	Redial key - Redials up to 100 previously dialed numbers. Pressing the Redial key twice simultaneously redials the last dialed number.
	Volume control key - Adjusts the volume for the handset, headset, ringer, and handsfree speaker.

Keys	Key Description
	<p>Line/Call Appearance key - Connects you to a line or call. The Aastra 6755i IP phone supports up to 4 line keys.</p>
	<p>Handsfree key - Activates Handsfree for making and receiving calls without lifting the handset. When the audio mode option is set, this key is used to switch between a headset and the handsfree speakerphone.</p>
	<p>Mute key - Mutes the microphone so that your caller cannot hear you (the light indicator flashes when the microphone is on mute).</p>
	<p>Navigation keys - Pressing the UP and DOWN arrow keys lets you view different status and text messages on the LCD display (if there is more than 1 line of status/text messages). These buttons also let you scroll through menu selections, such as the Options List.</p> <p>Pressing the LEFT and RIGHT arrow keys lets you view the different line/call appearances. While in the Options List, these keys allow you to exit or enter the current option. When you are editing entries on the display, pressing the LEFT arrow key erases the character on the left; pressing the RIGHT arrow key sets the option.</p>

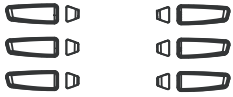
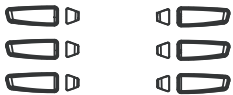
Keys	Key Description												
	<p>Programmable keys - 6 Top keys: programmable hard keys (up to 6 programmable functions)</p> <p>By default, keys 1 through 4 are assigned as Services, Directory, Callers List, and Intercom, respectively. Keys 5 and 6 have no assigned functions. All 6 keys are programmable and can be assigned to perform specific functions.</p> <p>The following are the default functions for the programmable keys on the 6755i IP phone:</p> <table border="0"> <tr> <td style="vertical-align: top;">1 SERVICES</td> <td>Accesses enhanced features and services such as XML applications and voicemail, provided by third parties.</td> </tr> <tr> <td style="vertical-align: top;">2 DIRECTORY</td> <td>Accesses the Directory List which displays up to 200 names and phone numbers (stored in alphabetical order)</td> </tr> <tr> <td style="vertical-align: top;">3 CALLERS LIST</td> <td>Accesses the Callers List which lists the last 200 calls received.</td> </tr> <tr> <td style="vertical-align: top;">4 INTERCOM</td> <td>Automatically connects with a remote extension for outgoing calls, and answers incoming intercom calls.</td> </tr> <tr> <td style="vertical-align: top;">5 NONE</td> <td>No assigned function</td> </tr> <tr> <td style="vertical-align: top;">6 NONE</td> <td>No assigned function</td> </tr> </table> <p>The following softkeys display when you pick up the handset:</p> <ul style="list-style-type: none"> • DIAL- After entering a phone number from the keypad, you can press the Dial softkey to immediately dial the number. • CONF - Begins a conference with the active call. • XFER - Transfers the active call to another number. <p>For more information about programming the programmable keys to perform specific functions, see the “Softkeys and Programmable Keys” on page 61.</p>	1 SERVICES	Accesses enhanced features and services such as XML applications and voicemail, provided by third parties.	2 DIRECTORY	Accesses the Directory List which displays up to 200 names and phone numbers (stored in alphabetical order)	3 CALLERS LIST	Accesses the Callers List which lists the last 200 calls received.	4 INTERCOM	Automatically connects with a remote extension for outgoing calls, and answers incoming intercom calls.	5 NONE	No assigned function	6 NONE	No assigned function
1 SERVICES	Accesses enhanced features and services such as XML applications and voicemail, provided by third parties.												
2 DIRECTORY	Accesses the Directory List which displays up to 200 names and phone numbers (stored in alphabetical order)												
3 CALLERS LIST	Accesses the Callers List which lists the last 200 calls received.												
4 INTERCOM	Automatically connects with a remote extension for outgoing calls, and answers incoming intercom calls.												
5 NONE	No assigned function												
6 NONE	No assigned function												
	<p>Softkeys - 6 Bottom keys: programmable state-based softkeys (up to 20 programmable functions).</p> <p>For more information about programming the softkeys to perform specific functions, see the “Softkeys and Programmable Keys” on page 61.</p>												

Methods for Customizing Your Phone

There are two ways to customize specific options on your phone:

- Using the Options  key on the IP Phone
- Using the Aastra Web UI in an Internet browser window from your PC.

Phone Options via the IP Phone UI

You can customize your phone by pressing the Options  key and accessing the IP Phone UI.

These options allow you to customize the following phone settings.

Option Number	Option
1	<p>Call Forward</p> <ol style="list-style-type: none"> 1. Cfdw Number 2. Cfdw Mode 3. No. Rings <p>Note: The menus that display for Call Forward are dependant on the Call Forward Mode set on the phone. Default is "Account" mode.</p>
2	<p>Preferences</p> <ol style="list-style-type: none"> 1. Tones <ul style="list-style-type: none"> Ring Tone Tone Set 2. Contrast Level 3. Speeddial Edit 4. Live Dialpad 5. Set Audio <ul style="list-style-type: none"> Audio Mode Headset Mic Vol 6. Time and Date <ul style="list-style-type: none"> Time Zone Daylight Savings Time Format Date Format Time Server <ul style="list-style-type: none"> Time Server 1 Time Server 2 Time Server 3 Set Time Set Date 7. Language <ul style="list-style-type: none"> Screen Language Input Language

3	Phone Status 1. IP&MAC Addresses 2. LAN Port 3. PC Port 4. Firmware Info 5. Error Messages
4	User Password
5	Administrator Menu (Password Protected)
6	Restart Phone
7	Phone Lock



Note: *The "Administrator Menu" options are Administrator level functions only, and are not accessible by the user. These options should only be set up and changed by your System Administrator.

Simplified Options Menu



Your System Administrator may configure a simplified options menu for your phone. The following table indicates the options that may appear on your phone if the simplified options menu is applied.

Option Number	Option
1	Call Forward 1. Cfdw Number 2. Cfdw Mode 3. No. Rings Note: The menus that display for Call Forward are dependant on the Call Forward Mode set on the phone. Default is "Account" mode.
2	Preferences 1. Tones Ring Tone Tone Set 2. Contrast Level 3. Live Dialpad 4. Set Audio Audio Mode Headset Mic Vol
3	Phone Status 1. IP&MAC Addresses 2. LAN Port 3. PC Port 4. Firmware Info 5. Error Messages
4	Phone Lock

Using the IP Phone UI



IP Phone UI

1. Press the Options key  on the phone to enter the Options List.
2. To go to an **Option**, use 5 and 2 to scroll through the list, or press the number corresponding to the **Option**.
3. Press the **Select** softkey, the 4 button, or press the digit number of the corresponding option to select an option.
4. Use the softkeys that display for each option to change a selected option.
5. Press the **Done** button to save the change.
6. Press the  button, the 3 button, or the  button at any time to exit without saving changes.

References

For more information about customizing your phone using the available options from the IP Phone UI, see the section [“Customizing Your Phone”](#) on [page 27](#).

For more information about Administrator options, contact your System Administrator.

Phone Options via the Aastra Web UI

In addition to the IP Phone UI options, you can customize additional options on the IP Phone using the Aastra Web UI. In order to access your phone using the Aastra Web UI, you need to know your phone's IP address. To find your phone's IP address, see [“Finding Your Phone's IP Address”](#) on page 23.

Using the Aastra Web UI



Aastra Web UI

1. Open your web browser, enter the phone's IP address or host name into the address field and press **<Enter>**.

The following logon screen displays.

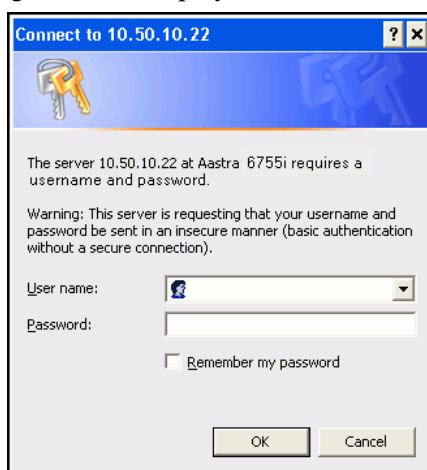

2. At the prompt, enter your username and password and click .



Note: For a user, the default user name is **“user”** and the password field is left blank.

The Network Status window displays for the IP phone you are accessing.

AASTRA 6755i
Log Off

Status
System Information

Operation
User Password
Phone Lock
Softkeys and XML
Programmable Keys
Keypad Speed Dial
Directory
Reset

Basic Settings
Preferences
Account Configuration

Network Status

Attribute	LAN Port	PC Port
Link State	Up	Down
Negotiation	Auto	Auto
Speed	100Mbps	10Mbps
Duplex	Full	Half
MAC Address:	00-08-5D-16-10-F4	

Hardware Information

Attribute	Value
Platform	55i Revision 0

Firmware Information

Attribute	Value
Firmware Version	2.5.0.83
Firmware Release Code	SIP
Boot Version	2.3.0.1225
Date/Time	Jun 30 2008 23:57:25

SIP Status

Line	SIP Account	Status	Backup Registrar Used?
1	9995551212@proxy.com:5060	Registered	Yes
2	9995551212@proxy.com:5060	Registered	Yes
3	9995551212@proxy.com:5060	Registered	Yes

3. You can logout of the Aastra Web UI at any time by clicking **Log Off**.

The following categories display in the side menu of the Aastra Web UI: **Status, Operation, Basic Settings.**

Headings	Descriptions
Status	The Status section displays the network status and the MAC address of the IP phone. It also displays hardware and firmware information about the IP phone, and information about the SIP account(s) currently configured on the phone. The information in the Network Status window is read-only.
Operation	<p>User Password - Allows you to change user password.</p> <p>Phone Lock - Allows you to assign an emergency dial plan to the phone, lock the phone to prevent any changes to the phone and to prevent use of the phone, and reset the user password.</p> <p>Keypad Speeddial - Allows you to assign a speeddial number to a specific digit on the phone's keypad for speeddialing purposes.</p> <p>Softkeys and XML - Allows you to configure up to 6 bottom softkeys with functions identified in the list below.</p> <p>Programmable Keys - Allows you to configure up to 6 top programmable keys. By default, Keys 1 through 4 are programmed as Services, Directory, Callers List, and Intercom, respectively. You can configure any of the six keys with the functions identified in the list below.</p> <p>Available Functions for Softkeys and Programmable Keys</p> <ul style="list-style-type: none"> • none • line • speeddial • do not disturb (DND) • Busy Lamp Field (BLF) • BLF List • Auto Call Distribution (ACD) • Directed Call Pickup • Extensible Markup Language (XML) • flash • sprecode • park • pickup • Last Call Return (lcr) • Call Forward • BLF/Xfer • Speeddial/Xfer • Speeddial/Conf • Directory • Callers List • Intercom • Services • Phone Lock • Paging • Empty <p>Expansion Module - Allows you to configure an additional 36 softkeys with a M670i Expansion Module, or an additional 60 softkeys with a M675i Expansion Module if it is attached to the phone. This option displays on the side menu of the Aastra Web UI only if an Expansion Module is attached. Not all functions in the table above apply to the Expansion Modules.</p> <p>Directory - Allows you to copy the Callers List and Directory List from your IP phone to your PC.</p> <p>Reset - Allows you to restart the IP phone when required.</p>

Headings	Descriptions
<p>Basic Settings</p>	<p>Preferences - Allows you to enable/disable the following:</p> <ul style="list-style-type: none"> • Park Call • Pickup Parked Call • Suppress DTMF Playback • Display DTMF Digits • Call Waiting • Play Call Waiting Tone • Stuttered Dial Tone • XML Beep Support • Status Scroll Delay (seconds) • Incoming Call Interrupts Dialing • Switch UI Focus to Ringing Line • Preferred Line • Preferred Line Timeout (seconds) • Goodbye Key Cancels Incoming Call • UPnP Mapping Lines • Message Waiting Indicator Line • DND Key Mode • Call Forward Key Mode • Use LLDP ELIN <p>This category also allows you to configure:</p> <ul style="list-style-type: none"> • incoming Intercom call settings • group paging RTP settings • ring tones (global and per-line basis) • ring tone sets • time and date settings • Webpage language and input language <p>Account Configuration - Allows you to configure “do not disturb” (DND) and “call forwarding” (CFWD) by account. You can have multiple accounts on the 6755i.</p>

Phone Status

You can view the status of your phone using the IP Phone UI or the Aastra Web UI.

Phone Status via IP Phone UI

The "**Phone Status**" option on the IP phone displays the status of your phone to the LCD display.

This option allows you to view your phone's:

- Network status including your phone's IP and MAC address
- Local Area Network (LAN) port information
- PC Port information (if PC link exists)
- Firmware version
- Error messages from the last reboot or startup

Use the following procedure to view the status of your phone using the IP Phone UI.



IP Phone UI

1. Press  on the phone to enter the Options List.
2. Select **Phone Status**.
3. Select the option you want to view:
 - **IP&MAC Address**
 - **LAN Port**
 - **PC Port**
 - **Firmware Info**
 - **Error Messages**

The option you select displays to the LCD. Use the 5 and 2 keys to scroll the through the LCD display.

Finding Your Phone's IP Address

If you want to access your phone's options using an Internet browser, you need to enter the IP address of the phone in the browser to open the Aastra Web UI. Use the following procedure to find your phone's IP address.



IP Phone UI

1. Press  to enter the Options List.
2. Scroll to **Phone Status** and press **Select**.

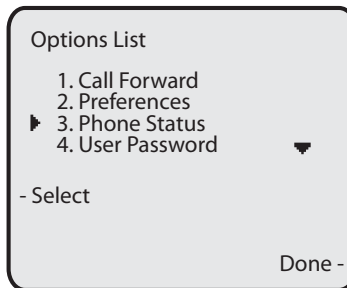

3. Scroll to **IP&MAC Addresses** and press **Select**.

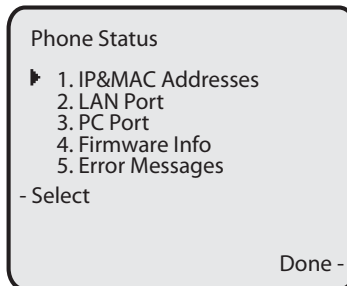

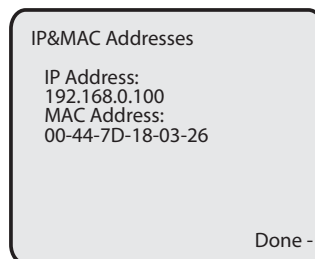

The IP address of your 6755i IP phone displays in the "**IP Address**" field.

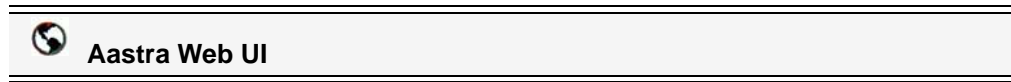

Phone Status via the Aastra Web UI

Use the following procedure to view the phone status via the Aastra Web UI.



1. Open your web browser, enter the phone's IP address or host name into the address field and press **<Enter>**.
2. In the Username/Password window, enter your username and password and click .



Note: For a user, the default user name is “**user**” and the password field is left blank.

The Network Status window displays for the IP phone you are accessing.

Attribute	LAN Port	PC Port
Link State	Up	Down
Negotiation	Auto	Auto
Speed	100Mbps	10Mbps
Duplex	Full	Half

MAC Address: 00-08-5D-16-10-F4

Attribute	Value
Platform	55i Revision 0

Attribute	Value
Firmware Version	2.5.0.83
Firmware Release Code	SIP
Boot Version	2.3.0.1225
Date/Time	Jun 30 2008 23:57:25

Line	SIP Account	Status	Backup Registrar Used?
1	9995551212@proxy.com:5060	Registered	Yes
2	9995551212@proxy.com:5060	Registered	Yes
3	9995551212@proxy.com:5060	Registered	Yes

This Network Status window is view only. It displays the Network Status of your phone which includes the following:

- Link State, Negotiation, Speed, and Duplex setting for the LAN and PC ports
- MAC Address
- Hardware Information
- Firmware Information
- SIP Account status

SIP Account Status

The IP Phones show the SIP registration status on the IP Phone's Network Status screen in the Aastra Web UI.

The following is an illustration of the Network Status screen in the Aastra Web UI with SIP status displayed.

6755i
Log Off

Status
System Information

Operation
User Password
Phone Lock
Softkeys and XML
Programmable Keys
Keypad Speed Dial
Directory
Reset

Basic Settings
Preferences
Account Configuration

Network Status

Attribute	LAN Port	PC Port
Link State	Up	Down
Negotiation	Auto	Auto
Speed	100Mbps	10Mbps
Duplex	Full	Half

MAC Address: 00-08-5D-16-10-F4

Hardware Information

Attribute	Value
Platform	55i Revision 0

Firmware Information

Attribute	Value
Firmware Version	2.5.0.83
Firmware Release Code	SIP
Boot Version	2.3.0.1225
Date/Time	Jun 30 2008 23:57:25

SIP Status

Line	SIP Account	Status	Backup Registrar Used?
1	9995551212@proxy.com:5060	Registered	Yes
2	9995551212@proxy.com:5060	Registered	Yes
3	9995551212@proxy.com:5060	Registered	Yes

SIP Account Status

The following table describes the status conditions that can display for the account.

Status Condition	Description								
Registered	<p>Displays this status on accounts that HAVE been registered with the SIP proxy server.</p> <p>Example:</p> <table border="0"> <thead> <tr> <th data-bbox="505 474 565 499">Line</th> <th data-bbox="618 474 764 499">SIP Account</th> <th data-bbox="1143 474 1219 499">Status</th> <th data-bbox="1312 415 1422 499">Backup Registrar Used?</th> </tr> </thead> <tbody> <tr> <td data-bbox="505 506 521 531">1</td> <td data-bbox="618 506 1089 531">9057604603@anasiproxy.aastra.com:5060</td> <td data-bbox="1143 506 1260 531">Registered</td> <td data-bbox="1312 506 1357 531">Yes</td> </tr> </tbody> </table> <p>where Account Number is "1" SIP Account is "9057604603@anasiproxy.aastra.com" on port "5060" Status is "Registered" Backup registrar is used ("Yes")</p>	Line	SIP Account	Status	Backup Registrar Used?	1	9057604603@anasiproxy.aastra.com:5060	Registered	Yes
Line	SIP Account	Status	Backup Registrar Used?						
1	9057604603@anasiproxy.aastra.com:5060	Registered	Yes						
SIP Error Number	<p>Displays on accounts when registration fails with the SIP proxy server.</p> <p>Example:</p> <table border="0"> <thead> <tr> <th data-bbox="505 867 565 892">Line</th> <th data-bbox="618 867 764 892">SIP Account</th> <th data-bbox="1143 867 1219 892">Status</th> <th data-bbox="1312 808 1422 892">Backup Registrar Used?</th> </tr> </thead> <tbody> <tr> <td data-bbox="505 898 521 924">4</td> <td data-bbox="618 898 1089 924">9057604601@anasiproxy.aastra.com:5060</td> <td data-bbox="1143 898 1188 924">401</td> <td data-bbox="1312 898 1347 924">No</td> </tr> </tbody> </table> <p>where Account Number is "4" SIP Account is "9057604601@anasiproxy.aastra.com" on port "5060" Status is "401" - Unregistered if SIP registration fails. Backup registrar is used ("No")</p>	Line	SIP Account	Status	Backup Registrar Used?	4	9057604601@anasiproxy.aastra.com:5060	401	No
Line	SIP Account	Status	Backup Registrar Used?						
4	9057604601@anasiproxy.aastra.com:5060	401	No						

Customizing Your Phone

The following paragraphs describe the options available from either the IP Phone UI, the Aastra Web UI, or both, and provide procedures applicable to the option.

Ring Tones and Tone Sets

You can configure ring tones and ring tone sets on the IP phone.

Ring Tones

There are several distinct ring tones a user can select from to set on the IP phones. You can enable/disable these ring tones on a global or per-line basis.

The following table identifies the valid settings and default values for each type of configuration method.

Ring Tones Table

Configuration Method	Valid Values	Default Value
IP Phone UI	Global Tone 1 Tone 2 Tone 3 Tone 4 Tone 5 Silent	Global Setting: Tone 1
Aastra Web UI	Global: Tone 1 Tone 2 Tone 3 Tone 4 Tone 5 Silent	Global Setting: Tone 1
Lines 1 to 9	Per-Line Setting: Global Tone 1 Tone 2 Tone 3 Tone 4 Tone 5 Silent	Per-Line Setting: Global

Ring Tone Sets

In addition to ring tones, you can configure ring tone sets on a global-basis on the IP phone. Ring tone sets consist of tones customized for a specific country. The ring tone sets you can configure on the IP phones are:

- United States (US) (Default - also used in Canada)
- Mexico
- Brazil
- United Kingdom (UK)
- Italy
- Germany
- France
- Europe (generic tones)
- Australia

When you configure the country's tone set, the country-specific tone is heard on the phone for the following:

- dial tone
- secondary dial tone
- ring tone
- busy tone
- congestion tones
- call waiting tone
- ring cadence pattern

You configure global ring tones and tone sets using the Aastra Web UI and the IP Phone UI.

Configuring Ring Tones and Tone Sets



IP Phone UI

Use the following procedures to configure ring tones and tone sets on the IP phone.

Global configuration only

1. Press  on the phone to enter the Options List.
2. Select **Preferences**.
3. Select **Tones**.
4. Select **Ring Tone**.

5. Select the type of ring tone (**Tone 1** through **Tone 5**, or **Silent**).
6. Press **Done**.
7. Select **Tone Set**.
8. Select the country for which you want to apply the tone set. Valid values are **Australia, Europe, France, Germany, Italy, UK, Mexico, Brazil**, and **US**. Default is **US**.
9. Press **Done**.
The ring tone and tone set you select is immediately applied to the IP phone.



1. Click on **Basic Settings->Preferences->Ring Tones**.

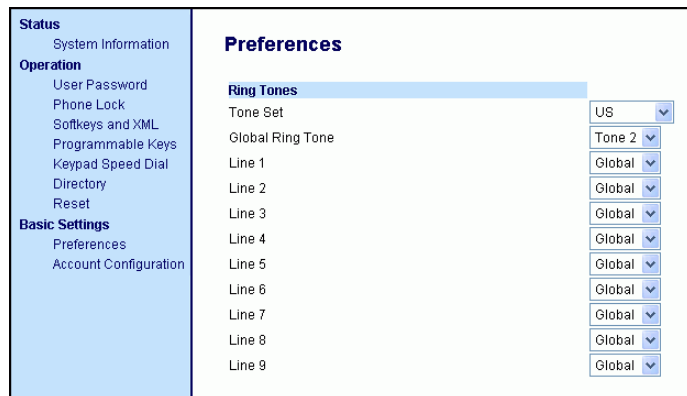

For global configuration:

2. In the "**Ring Tones**" section, select a country from the "**Tone Set**" field.
Valid values are **Australia, Europe, France, Germany, Italy, UK, Mexico, Brazil**, and **US**.
Default is **US**.
3. Select a value from the "**Global Ring Tone**" field.



Note: See the [Ring Tones Table](#) on [page 27](#) for valid values.

For per-line configuration:

4. In the "**Ring Tone**" section, select a line for which you want to set ring tone.
5. Select a value from the "**LineN**" field.



Note: See the [Ring Tones Table](#) on [page 27](#) for valid values.

6. Click  to save your settings.

Contrast Level

The "**Contrast Level**" option on the IP phone allows you to set the amount of light that illuminates the LCD display. Use this option to set the preference of contrast level.

You can set the contrast level using the IP Phone UI only.

Setting Contrast Level



1. Press  on the phone to enter the Options List.
2. Select **Preferences**.
3. Select **Display**.
4. Select **Contrast Level**.

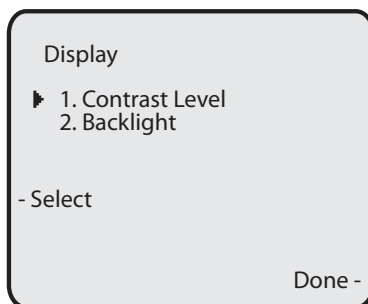

5. Use the 3 and 4 navigation buttons to increase or decrease the intensity of contrast lighting on the LCD.

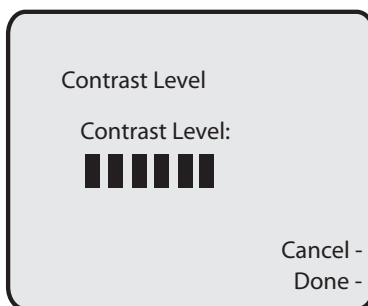

6. Press **Done** to save your selection.

Backlight

The "**Backlight**" option on the IP phone allows you to set the backlight status on the LCD display to the following:

- **Off** - Backlight is always OFF.
- **Auto** (Default)- Automatically turns ON the backlight when the phone is in use, and then automatically turns OFF the backlight when the phone is idle after a specified length of time.

Auto backlighting sets the phone to turn off the backlighting after a period of inactivity; the idle period is user definable under the Advanced softkey when you select the Auto mode. In Auto mode, the backlight turns on with a key press or state change on the phone.

Setting the Backlight



IP Phone UI

1. Press  on the phone to enter the Options List.
2. Select **Preferences**.
3. Select **Display**.
4. Select **Backlight**.

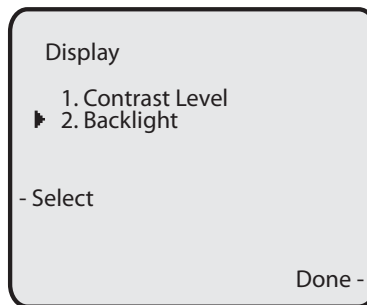

5. Use the 5 and 2 navigation buttons to select the Backlight status for your phone. Default is "**Auto**". Available options are:
 - **Off**
 - **Auto** (Default)
6. If you selected "**Off**", press **Done** to save your setting.

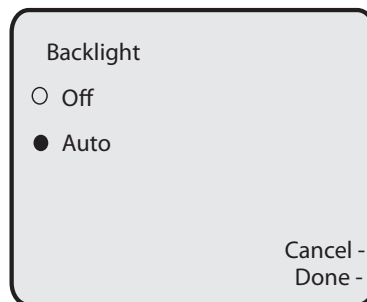

- 7. If you selected "**Auto**", press the **Advanced** softkey.

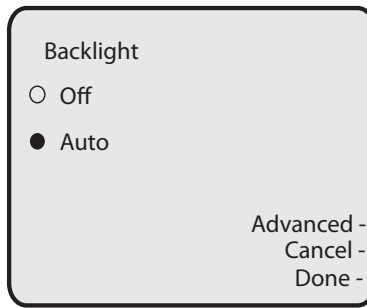

- 8. Using the keypad, enter the amount of seconds you want the phone to stay backlit when the phone is idle. Valid values are **1** to **120** seconds (2 minutes). Default is **10 seconds**. When this period of time is reached, the phone turns OFF the backlight. Use the "**Backspace**" and/or "**Clear**" softkeys to delete entries if required.

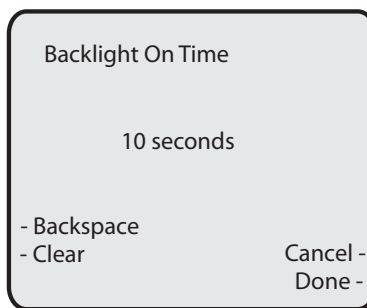

- 9. Press **Done** to save your setting.

Live Dialpad*

The "**Live Dialpad**" option on the IP phone turns the Live Dial Pad mode ON or OFF. With live dial pad ON, the 6755i IP phone automatically dials out and turns ON Handsfree mode as soon as a dial pad key or softkey is pressed. With live dial pad OFF, if you dial a number while the phone is on-hook, lifting the receiver or pressing the  initiates a call to that number.

*Availability of feature dependant on your phone system or service provider.

You can enable/disable the live dialpad using the IP Phone UI only.

Enabling/Disabling Live Dialpad



1. Press  on the phone to enter the Options List.
2. Select **Preferences**.
3. Select **Live Dialpad**.

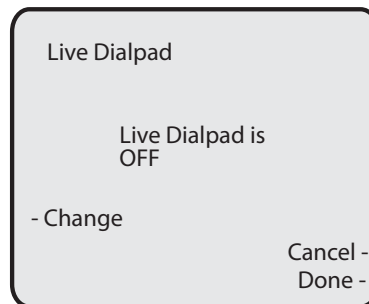

4. Use the **Change** softkey to turn the live dialpad ON or OFF.
5. Press **Done** to save your setting.





Set Audio

The "Set Audio" option on the IP Phone allows you to set the audio mode for your IP phone. It also allows you to set the volume level of the headset microphone.

You can set Audio on your IP phone using the IP Phone UI only.

Audio Mode

The 6755i allows you to use a handset, a headset, or handsfree mode to handle incoming and outgoing calls. The audio mode option provides different combinations of these three methods to provide maximum flexibility in handling calls. There are four audio mode options you can set:

Audio Mode Option	Description
Speaker	This is the default setting. Calls can be made or received using the handset or handsfree speakerphone. In handset audio mode, pressing the  button on the phone switches to handsfree speakerphone. In Speaker audio mode, lift the handset to switch to the handset.
Headset	Choose this setting if you want to make or receive all calls using a handset or headset. Calls can be switched from the handset to headset by pressing the  button on the phone. To switch from the headset to the handset, lift the handset.
Speaker/Headset	Incoming calls are sent to the handsfree speakerphone first when the  button is pressed. By pressing the button again, you can switch back and forth between the handsfree speakerphone and the headset. At anytime, lifting the handset switches back to the handset from either the handsfree speakerphone or the headset.
Headset/Speaker	Incoming calls are sent to the headset first when the  button is pressed. By pressing the button again, you can switch back and forth between the headset and the handsfree speakerphone. At anytime, lifting the handset switches back to the handset from either the headset or the handsfree speakerphone.

Headset Mic Volume

The "Headset Mic Volume" option allows you to set the volume level for the headset microphone.

Setting Audio Mode and Headset Mic Volume



IP Phone UI

1. Press on the phone to enter the Options List.
2. Select **Preferences**.
3. Select **Set Audio**.
4. Select **Audio Mode**.

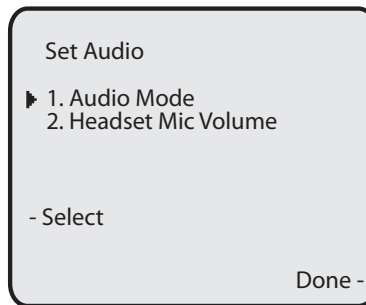

5. Select the audio mode you want to use on your phone. Default is **Speaker**.
Valid values are:
 - **Speaker** (Default)
 - **Headset**
 - **Speaker/Headset**
 - **Headset/Speaker**

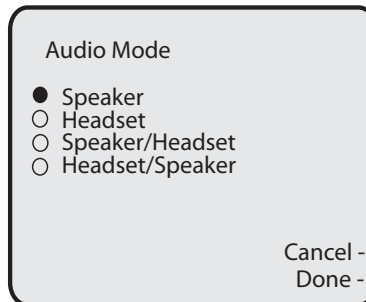

6. Press **Done** to save your setting.

7. Select **Headset Mic Volume**.

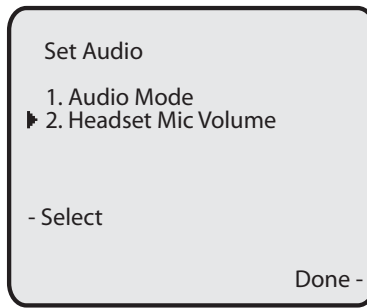

8. Select the **Low**, **Medium**, or **High** volume level. Default is **Medium**.

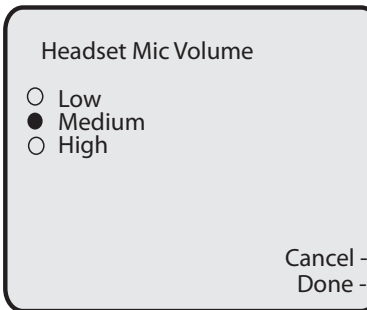

9. Press **Done** to save your selection.

Time and Date

On the IP phones, you can configure the following:

- Time and date
- Time and date format
- Time zone
- Daylight savings time
- Time Servers



Note: Only the Time and Date Formats and Time Servers can be set using the Aastra Web UI.

Configuring Time and Date

Use the following procedures to configure the time and date settings on the IP phone.



IP Phone UI

Set Time and Time Format



Note: The time and time format you configure display on the phone's idle screen.

1. Press  on the phone to enter the Options List.
2. Select **Preferences**.
3. Select **Time and Date**.
4. Select **Set Time**.

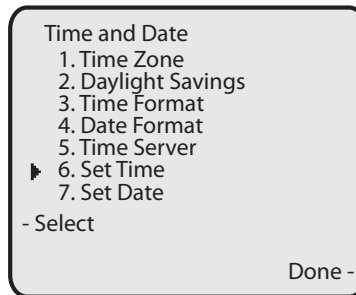

- Using the keys on the keypad, enter a time to set on the IP phone. Use the "**Backspace**" key to move back a space and delete a character. Use the "**AM/PM**" softkey to specify either AM or PM for the time setting.

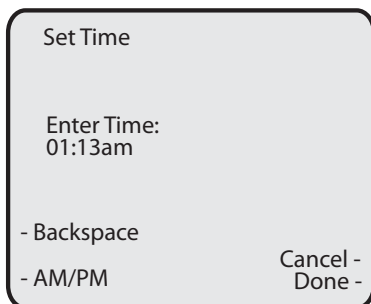

- Press **Done** to save the setting.
- Select **Time Format**.
- Using the "**Change**" softkey, set the Time Format to either a 12 hour format or a 24 hour format. Valid values are **12h** and **24h**. Default is **12h**.

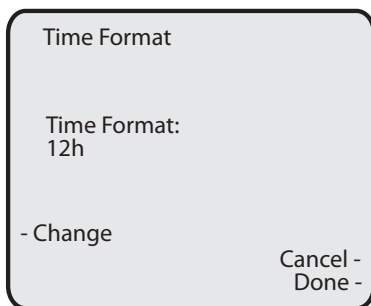

- Press **Done** to save the Time Format you selected.

Set Date and Date Format



Note: The date and date format you configure display on the phone's idle screen.

- Select **Preferences**.
- Select **Time and Date**.
- Select **Set Date**.

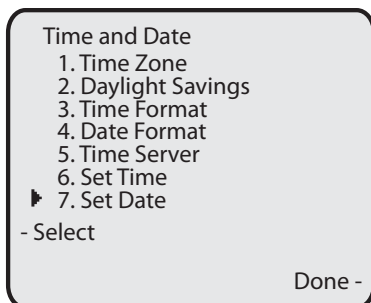

4. Using the keys on the keypad, enter a date to set on the IP phone. Use the "**Backspace**" key to move back a space and delete a character.

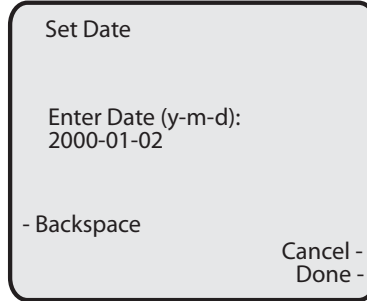

Set Date

Enter Date (y-m-d):
2000-01-02

- Backspace

Cancel -
Done -

5. Press **Done** to save the setting.
6. Select **Date Format**.
7. Select a date format from the list of options. Default is **Sun Jan 2**. Valid values are:
- Sun Jan 2 (Default)
 - 2-Jan-00
 - 2000 01 02
 - 02/01/2000
 - 02/01/00
 - 02-01-00
 - 01/.02/00
 - Jan 2
 - 2 Jan 2000
 - Sun 2 Jan
 - 2 Jan
 - 02.01.2000

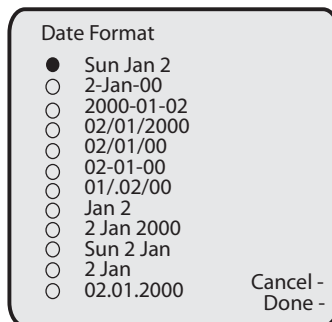

Date Format

- Sun Jan 2
- 2-Jan-00
- 2000-01-02
- 02/01/2000
- 02/01/00
- 02-01-00
- 01/.02/00
- Jan 2
- 2 Jan 2000
- Sun 2 Jan
- 2 Jan
- 02.01.2000

Cancel -
Done -

8. Press **Done** to save the Date Format.

Set Time Zone

1. Select **Preferences**.
2. Select **Time and Date**.
3. Select **Time Zone**.

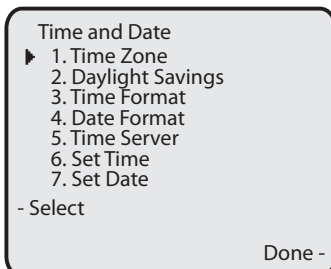

A list of Time Zones display for different areas of the world.

4. Select a Time Zone that applies to your area.
The default Time Zone is **US-Eastern**.

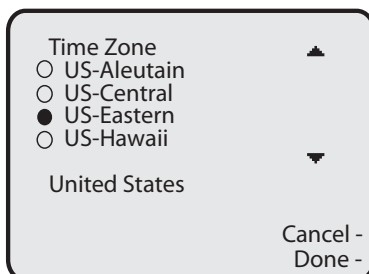

Note: For a list of the Time Zones values available on the IP Phone, see [‘Appendix A - Time Zone Codes.’](#)

5. Press **Done** to save the Time Zone setting.

Daylight Savings Time

1. Select **Preferences**.
2. Select **Time and Date**.
3. Select **Daylight Savings**.

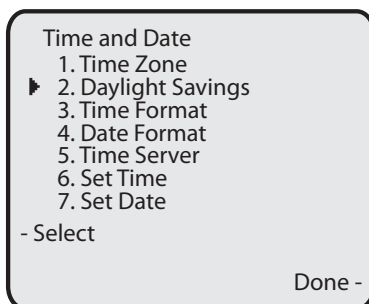

4. Select a Daylight Savings time from the list of options. Default is **Automatic**. Valid values are:
 - **OFF**
 - **30 min summertime**
 - **1h summertime**
 - **Automatic (Default)**

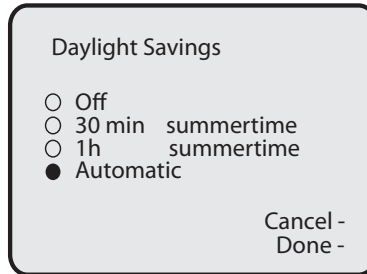

5. Press **Done** to save the Daylight Savings value you selected.

Set Time Servers

With a valid time server enabled your IP phone will synchronize the time displayed with the specified configuration server. The phone will use the time from Time Server 1 unless it is not configured or unavailable, in which case it will move on to Time Server 2, and if necessary Time Server 3.

1. Select **Preferences**.
2. Select **Time and Date**.
3. Select **Time Server**.

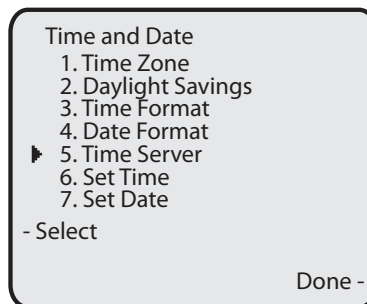

4. Select from **Time Server 1**, **Time Server 2**, or **Time Server 3**.

5. Enable the time server if required using the "Enable" key.

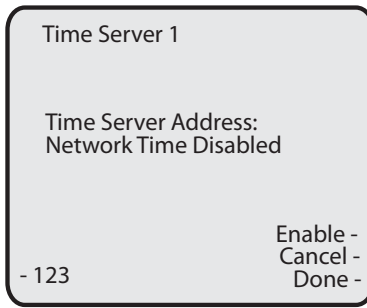

Note: The default for Time Servers is **Enabled**.

6. Using the keys on the keypad, enter an IP address or domain name for the time server. Use the "Backspace" key to move back a space and delete a character. Use the "Dot" softkey to enter dots within the IP address or domain name. Use the "123" softkey to toggle between entering numbers and entering letters.

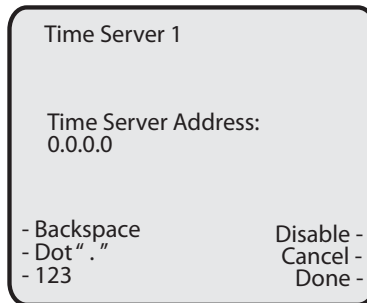

7. Press **Done** to save the time server setting.



Aastra Web UI

1. Click on **Basic Settings->Preferences->Time and Date Setting**.

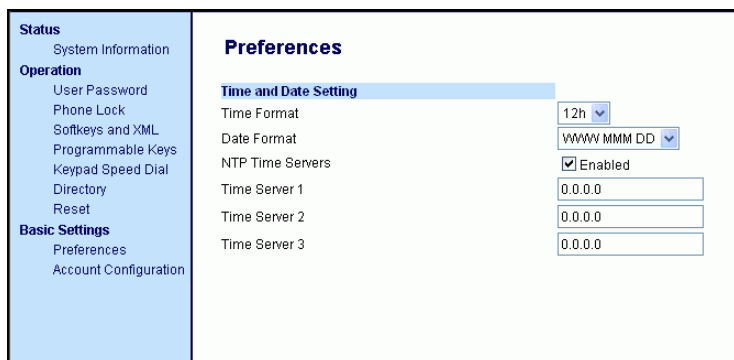

2. In the "Time Format" field, select the time format you want to use on your phone. Valid values are:
 - **12h** (12 hour format) (default)

- **24h** (24 hour format)



Note: The time and time format you configure display on the phone's idle screen.

3. In the **“Date Format”** field, select the date format you want to use on your phone. Default is **WWW MMM DD**. Valid values are:
 - WWW MMM DD (default)
 - DD-MMM-YY
 - YYYY-MM-DD
 - DD/MM/YYYY
 - DD/MM/YY
 - DD-MM-YY
 - MM/DD/YY
 - MMM DD
 - DD MMM YYYY
 - WWW DD MMM
 - DD MMM
 - DD.MM.YYYY



Note: The date and date format you configure display on the phone's idle screen.

4. In the **“NTP Time Servers”** field, enable by checking the checkbox or disable by unchecking the box (default is enabled).
5. In the **“Time Server 1”**, **“Time Server 2”**, and **“Time Server 3”** fields, enter IP addresses or qualified domain names for the primary, secondary, and tertiary time servers.



Note: Time Servers can only be entered if NTP Time Servers is enabled.

6. Click  to save your settings.

Language

The IP phones support several different languages. You can have the IP Phone UI and the Aastra Web UI display in a specific language as required. When you set the language to use, all of the display screens (menus, services, options, configuration parameters, etc.) display in that language. The IP phones support the following languages:

- English (default)
- French (Canadian)
- French (European)
- Spanish (Mexican)
- Spanish (European)
- German
- Italian
- Portuguese

You can also configure the language to use when inputting values in the Aastra Web UI and the IP Phone UI.

Specifying the Language to Use

Once the language pack(s) are available on your phone from your System Administrator, you can specify which language to use on the phone and/or the Aastra Web UI.



Note: All languages may not be available for selection. The available languages are dependant on the language packs currently loaded to the IP phone.



IP Phone UI

Use the following procedure to specify which language to use for the IP Phone UI.

1. Press  on the phone to enter the Options List.
2. Select **Preferences**.
3. Select **Language**.
4. Select **Screen Language**.
The current language setting displays on the IP Phone.

5. To change the language setting, use the 5 and 2 keys to scroll through the languages. Valid values are:

- **English** (default)
- **Français** (French)
- **Español** (Spanish)
- **Deutsch** (German)
- **Italiano** (Italian)
- **Português** (Portuguese)



Note: All languages may not be available for selection. The available languages are dependant on the language packs currently loaded to the IP phone. English is the default language and cannot be changed or removed. For more information about loading language packs, see your System Administrator.

6. Press **Done** to set the language on the phone.

The change is dynamic. When you exit the Options Menu, the phone displays all menu items in the language you selected.



Aastra Web UI



Note: You must have the language pack(s) already loaded to your phone in order to use them. For more information about loading language packs, see your System Administrator.

1. Click on **Basic Settings->Preferences->Language Settings**.

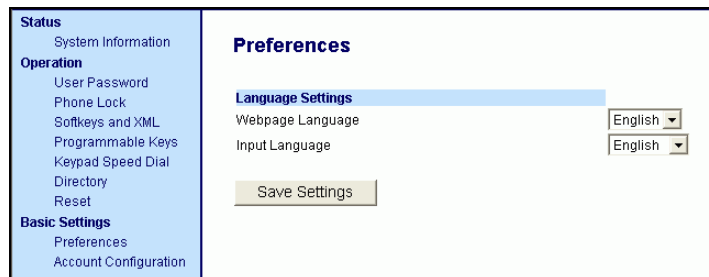

2. In the “**Webpage Language**” field, select a language to apply to the Aastra Web UI. The IP phone supports the following languages:

- **English** (default)
- **Français** (French)
- **Español** (Spanish)
- **Deutsch** (German)
- **Italiano** (Italian)
- **Português** (Portuguese)



Note: All languages may not be available for selection. The available languages are dependant on the language packs currently loaded to the IP phone by your System Administrator. English is the default language and cannot be changed or removed.

- Click  to save your settings. The change is dynamic. The Aastra Web UI displays all screens in the language you selected.

Language Input

The 6755i supports text and character inputs in various languages (English, German, French, Spanish, and Italian). Inputting textual or character information into the IP Phone UI can be done using the keypad on the phone. You enable the Language Input feature using the Aastra Web UI or the IP Phone UI. You can then use text and characters in a specific language when performing inputs on the phone.

The following tables identify the language characters that you can use to enter text and characters on the 6755i.

Keypad Input Alphabet Tables

English

Key	Uppercase Characters	Lowercase Characters
0	0	0
1	1.;=,-'&()	1.;=,-'&()
2	ABC2	abc2
3	DEF3	def3
4	GHI4	ghi4
5	JKL5	jkl5
6	MNO6	mno6
7	PQRS7	pqrs7
8	TUV8	tuv8
9	WXYZ9	wxyz9
*	* <SPACE>	* <SPACE>
#	#\@	#\@

French

Key	Uppercase Characters	Lowercase Characters
0	0	0
1	1.;=,_'&()	1.;=,_'&()
2	ABC2ÀÂÇÃÄÅÆ	abc2àâçáääæ
3	DEF3ÉÊËËË	def3éèèèè
4	GHI4Ï	ghi4ï
5	JKL5	jkl5
6	MNO6ÑÓÔÕÖ	mno6ñóòö
7	PQRS7	pqrs7
8	TUV8ÚÛÜÛ	tuv8úûü
9	WXYZ9	wxyz9
*	* <SPACE>	* <SPACE>
#	#^@	#^@

Spanish

Key	Uppercase Characters	Lowercase Characters
0	0	0
1	1.;=,_'&()	1.;=,_'&()
2	ABC2ÀÂÇ	abc2áâç
3	DEF3ÉÊ	def3éè
4	GHI4Ï	ghi4ï
5	JKL5	jkl5
6	MNO6ÑÓÔ	mno6ñóò
7	PQRS7	pqrs7
8	TUV8ÚÛ	tuv8úû
9	WXYZ9	wxyz9
*	* <SPACE>	* <SPACE>
#	#^@	#^@

German

Key	Uppercase Characters	Lowercase Characters
0	0	0
1	1.;=,-'&()	1.;=,-'&()
2	ABC2ÄÄ	abc2ää
3	DEF3É	def3é
4	GHI4	ghi4
5	JKL5	jkl5
6	MNO6Ö	mno6ö
7	PQRS7ß	pqrs7ß
8	TUV8Ü	tuv8ü
9	WXYZ9	wxyz9
*	* <SPACE>	* <SPACE>
#	#^@	#^@

Italian

Key	Uppercase Characters	Lowercase Characters
0	0	0
1	1.;=,-'&()	1.;=,-'&()
2	ABC2ÀÇ	abc2àç
3	DEF3ÈÈÈ	def3èèè
4	GHI4	ghi4
5	JKL5	jkl5
6	MNO6ÓÒ	mno6óò
7	PQRS7	pqrs7
8	TUV8Ù	tuv8ù
9	WXYZ9	wxyz9
*	* <SPACE>	* <SPACE>
#	#^@	#^@

Portuguese

Key	Uppercase Characters	Lowercase Characters
0	0	0
1	1.;=,_'&()	1.;=,_'&()
2	ABC2ÁÀÃÄÅÇ	abc2áàãäåç
3	DEF3ÉÊ	def3éê
4	GHI4Í	ghi4í
5	JKL5	jkl5
6	MNO6ÓÔÕ	mno6óôõ
7	PQRS7	pqrs7
8	TUV8ÚÛ	tuv8úü
9	WXYZ9	wxyz9
*	* <SPACE>	* <SPACE>
#	# / \ @	# / \ @

Configuring Language Input Using the IP Phone UI

You can configure the language you use for inputting on the phone by setting the **Input Language** option. The default input language setting is English. You can change this setting using the IP Phone UI or the Aastra Web UI.

Example

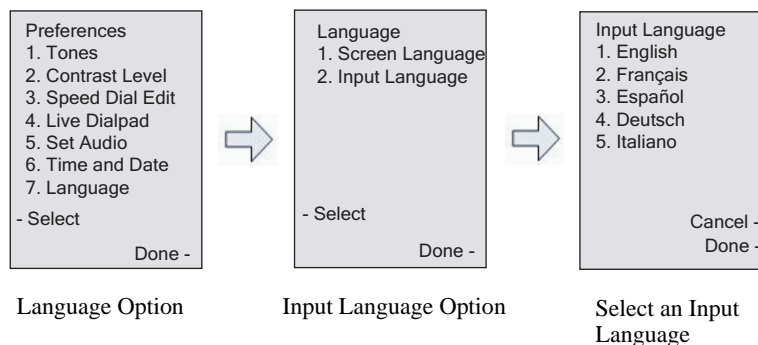

IP Phone UI

Use the following procedure to change the input language using the IP Phone UI.

1. Press  on the phone to enter the **Options List**.
2. Select **Preferences**.
3. Select **Language**.

4. Select **Input Language**.

Select the language you want to use when inputting text and characters into the IP Phone UI. Valid values are:

- **English** (default)
- **Français** (French)
- **Español** (Spanish)
- **Deutsch** (German)
- **Italiano** (Italian)
- **Português** (Portuguese)



Note: Available input languages are dependent on the configuration enabled by your System Administrator.

5. Press **Done** when you have selected an input language.



Aastra Web UI

Use the following procedure to set the input language using the Aastra Web UI.

1. Click on **Basic Settings-> Preferences->Language Settings**.

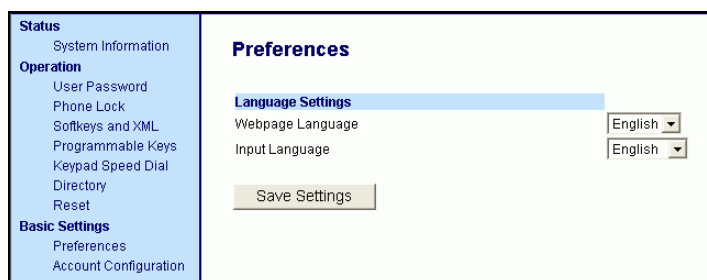

2. Select a language from the **"Input Language" field**. Setting this field allows you to specify the language to use when entering text and characters in the Aastra Web UI and IP Phone UI. Valid values are:

- **English** (default)
- **Français** (French)
- **Español** (Spanish)
- **Deutsch** (German)
- **Italiano** (Italian)



Note: All languages may not be available for selection. The available input languages are dependant on the configuration enabled by your System Administrator.

3. Click  to save your settings. The change is dynamic. The Aastra Web UI and IP Phone UI allow you to enter text and characters in the language you selected.

Latin 2 Character Set

The 6755i includes support for ISO 8859-2 (Latin2) of multi-national languages when displaying and inputting in the IP Phone UI and the Aastra Web UI.

UTF-8 is also compatible with XML encoding on the IP Phones.

The following table illustrates the Latin 2 character set used on the 6755i IP Phone.

	-0	-1	-2	-3	-4	-5	-6	-7	-8	-9	-A	-B	-C	-D	-E	-F
A-	NBSP 00A0 160	À 0104 161	Á 02D8 162	Â 0141 163	Ã 00A4 164	Ä 013D 165	Å 015A 166	Ş 00A7 167	Š 00A8 168	Ş 0160 169	Ť 015E 170	Ž 0164 171	Ž 0179 172	ŠHY 00AD 173	Ž 017D 174	Ž 017E 175
B-	° 00B0 176	ą 0105 177	ć 02DB 178	ł 0142 179	ł 00B4 180	ś 013E 181	ş 015B 182	ş 02C7 183	š 00B8 184	ş 0161 185	ť 015F 186	ž 0165 187	ž 017A 188	” 02DD 189	ž 017E 190	ž 017C 191
C-	Ř 0154 192	Á 00C1 193	Â 00C2 194	Ă 0102 195	Ä 00C4 196	Ĺ 0139 197	Ć 0106 198	Ç 00C7 199	Č 010C 200	É 00C9 201	Ę 0118 202	Ë 00CB 203	Ě 011A 204	Í 00CD 205	Î 00CE 206	Ď 010E 207
D-	Đ 0110 208	Ń 0143 209	Ň 0147 210	Ó 00D3 211	Ô 00D4 212	Õ 0150 213	Ö 00D6 214	× 00D7 215	Ř 0158 216	Ū 016E 217	Ú 00DA 218	Ů 0170 219	Û 00DC 220	Ÿ 00DD 221	Ť 0162 222	ß 00DF 223
E-	í 0155 224	á 00E1 225	â 00E2 226	ă 0103 227	ä 00E4 228	ĺ 013A 229	ć 0107 230	ç 00E7 231	č 010D 232	é 00E9 233	ę 0119 234	ë 00EB 235	ě 011B 236	í 00ED 237	î 00EE 238	ď 010F 239
F-	đ 0111 240	ń 0144 241	ň 0148 242	ó 00F3 243	ô 00F4 244	õ 0151 245	ö 00F6 246	÷ 00F7 247	ř 0159 248	ű 016F 249	ú 00FA 250	ů 0171 251	ü 00FC 252	ý 00FD 253	ț 0163 254	· 02D9 255

User Password

This category allows you to change the user password for your phone. Changing your password ensures that only you can alter your phone settings, and helps keep your system secure. You can change your user password using the IP Phone UI or the Aastra Web UI.

If you change the password	Then you need to:
using the IP Phone UI,	use that new password to log into the Aastra Web UI.
using the Aastra Web UI,	use that new password when changing the user password via the IP Phone UI.



Note: Valid values when creating or changing a password are 0 to 4294967295 (integers only; symbols and alpha characters are not allowed). Default password is an empty string "" (field is blank).

Setting a User Password



IP Phone UI



Note: If required, use the following keys while entering a password:

- **Backspace** softkey moves cursor back a space and deletes characters
- **Clear** softkey clears entire field of all characters
- **Quit** softkey cancels the password changing process without saving.

1. Press  on the phone to enter the Options List.
2. Select **User Password** and press **Select**.
3. At the "*Current Password:*" prompt, enter the current user password and press **Enter**.
4. At the "*New Password:*" prompt, enter the new user password and press **Enter**.
5. At the "*Re-enter Password:*" prompt, re-enter the new user password and press **Enter**. A message, "*Password Changed*" displays on the screen.



1. Click on **Operation->User Password**.

Status System Information	Reset User Password Please enter the current and new passwords
Operation User Password Phone Lock Softkeys and XML Programmable Keys Keypad Speed Dial Directory Reset	
Basic Settings Preferences Account Configuration	Current Password <input type="password"/> New Password <input type="password"/> Password Confirm <input type="password"/> <input type="button" value="Save Settings"/>

2. In the "**Current Password**" field, enter the current user password.



Note: By default, the user name is "user" (all lowercase) and the password field is left blank.

3. In the "**New Password**" field, enter the new user password.
4. In the "**Password Confirm**" field, enter the new user password again.
5. Click to save your changes.

Resetting a User Password

If you forget your password, you can reset it and enter a new password. The reset user password feature resets the password to the factory default which is blank (no password).

You can reset a user password using the Aastra Web UI only.



Note: Valid values when creating or changing a password are 0 to 4294967295 (integers only; symbols and alpha characters are not allowed). Default password is an empty string "" (field is blank).

Reset a User Password

Use the following procedure to reset a user password.

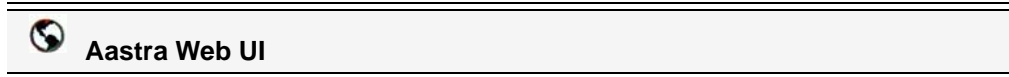

1. Click on **Operation->Phone Lock**.

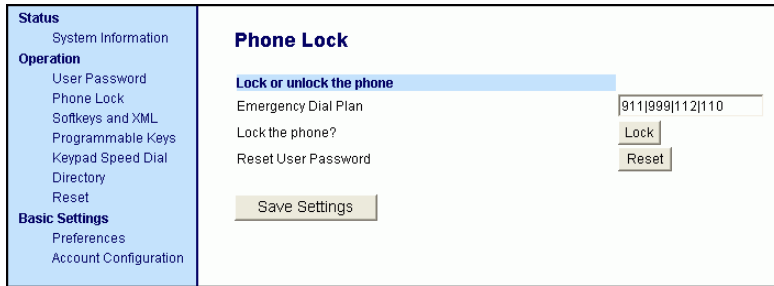

2. In the **"Reset User Password"** field, click **Reset**.
The following screen displays.

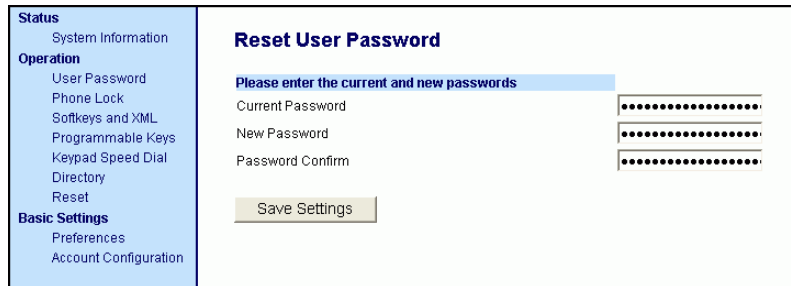



3. In the **"Current Password"** field, leave this blank.
4. In the **"New Password"** field, enter a new password.
5. In the **"Password Confirm"** field, re-enter your new user password.
6. Click **Save Settings** to save your settings.

Restarting your phone

You may want to restart your phone to check for updates on the server. You may occasionally need to restart your phone to set changes or updates to your phone or network settings. You may also need to restart your phone if you have been asked to do so by your System Administrator, or should you experience any unexpected behavior.

 **IP Phone UI**

1. Press the  button on the phone to enter the Options List.
2. Select **Restart Phone**.
3. When the prompt, "Are you sure you wish to restart the phone?" appears, press the **Restart** softkey. If you do not wish to restart your phone, press **Cancel**.

 **Note:** Your phone is out of service temporarily during the restart and downloading process.

 **Aastra Web UI**

1. Click on **Operation->Reset**.

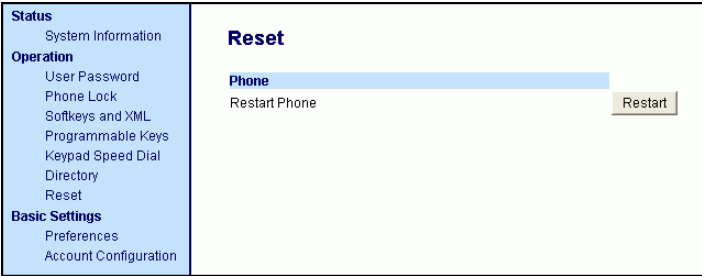

2. Click .
3. Click **OK** at the confirmation prompt.

Phone Lock

You can lock your phone to prevent the phone from being used or configured. You can lock the phone using any of the following:

- At the path *Options->Phone Lock* on the IP Phone UI.
- At the path *Operations->Phone Lock* on the Aastra Web UI.
- At a configured key on the phone. For more information about configuring a Lock/Unlock key on your phone, see [“Paging Key \(Sends the RTP Stream\)”](#) on [page 143](#).

In the Aastra Web UI, the *Operation->Phone Lock* path also allows you to perform the following:

- Reset a user password. Clicking on the **“Reset”** button in the **“Reset User Password”** field displays a screen that allows you to enter and save a new user password.
- Set an emergency dial plan. An emergency dial plan can be 911, 999, 112, 110 or all of the above. The default emergency dial plan is 911|999|112|110.

The following procedures describe locking the phone, setting an emergency dial plan, and resetting the user password.

Locking/Unlocking a Phone

Use the following procedures to lock an IP phone and prevent it from being used or configured.



IP Phone UI

Lock the Phone

1. Press on the phone to enter the Options List.
2. Select **Phone Lock** and press **Select**.
3. At the *"Lock the phone?"* prompt, press **Lock**.
The message *"Phone is locked"* displays.

Unlock the Phone

1. Press on the phone to enter the Options List.
2. At the prompt, *"To unlock the phone"*, enter your user password and press **Enter**.
The phone unlocks.



1. Click on **Operation->Phone Lock**.

Status System Information	Phone Lock
Operation User Password Phone Lock Softkeys and XML Programmable Keys Keypad Speed Dial Directory Reset	Lock or unlock the phone
Basic Settings Preferences Account Configuration	Emergency Dial Plan <input type="text" value="911 999 112 110"/>
	Lock the phone? <input type="button" value="Lock"/>
	Reset User Password <input type="button" value="Reset"/>
	<input type="button" value="Save Settings"/>

Lock the Phone

2. In the "**Lock the Phone?**" field, click .
The phone locks dynamically and displays the following message:
"Phone is locked".

Unlock the Phone

3. Click on **Operation->Phone Lock**.
4. In the "**Unlock the Phone?**" field, click .
The phone unlocks dynamically and displays the following message:
"Phone is unlocked".

Defining an Emergency Dial Plan

Public telephone networks in countries around the world have a single emergency telephone number (emergency services number), that allows a caller to contact local emergency services for assistance when required. The emergency telephone number may differ from country to country. It is typically a three-digit number so that it can be easily remembered and dialed quickly. Some countries have a different emergency number for each of the different emergency services.

You can specify the digits to dial on the IP phone for contacting emergency services. Once you specify the emergency number(s) on the phone, you can dial those numbers directly on the dial pad when required and the phone automatically dials to those emergency services.



Note: Contact your local phone service provider for available emergency numbers in your area.

The following table describes the default emergency numbers on the IP phones.

Emergency Number	Description
911	A United States emergency number
999	A United Kingdom emergency number
112	An international emergency telephone number for GSM mobile phone networks. In all European Union countries it is also the emergency telephone number for both mobile and fixed-line telephones.
110	A police and/or fire emergency number in Asia, Europe, Middle East, and South America.

You can set the emergency dial plan using the Aastra Web UI.

Define an Emergency Dial Plan

Use the following procedure to specify the numbers to use on your phone for dialing emergency services in your area.

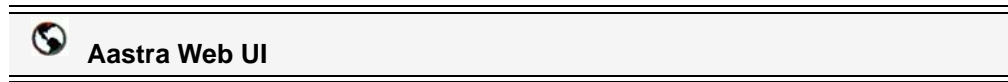

1. Click on **Operation->Phone Lock**.

The screenshot shows the "Phone Lock" configuration page in the Aastra Web UI. On the left is a navigation menu with categories: "Status" (System Information), "Operation" (User Password, Phone Lock, Softkeys and XML, Programmable Keys, Keypad Speed Dial, Directory, Reset), and "Basic Settings" (Preferences, Account Configuration). The "Phone Lock" option is selected. The main content area is titled "Phone Lock" and includes a sub-section "Lock or unlock the phone". It contains an "Emergency Dial Plan" field with the value "911|999|112|110", a "Lock the phone?" field with a "Lock" button, and a "Reset User Password" field with a "Reset" button. A "Save Settings" button is located at the bottom of the configuration area.

2. In the "**Emergency Dial Plan**" field, enter the 3-digit number used in your local area to contact emergency services. For multiple numbers, enter a "|" between each emergency number. For example:

911|110

Default for this field is **911|999|112|110**.

3. Click  to save the emergency dial plan to your phone.

Reference

For more advanced options you can set on your phone, see "[Additional Features](#)" on [page 211](#).

Line Keys, Programmable Keys, and Softkeys

This section describes the Multiple Line/Call Appearance Keys (L1, L2, L3, and L4) located on the bottom-right of the phone, and the customizable programmable keys and softkeys located at the top of the phone.

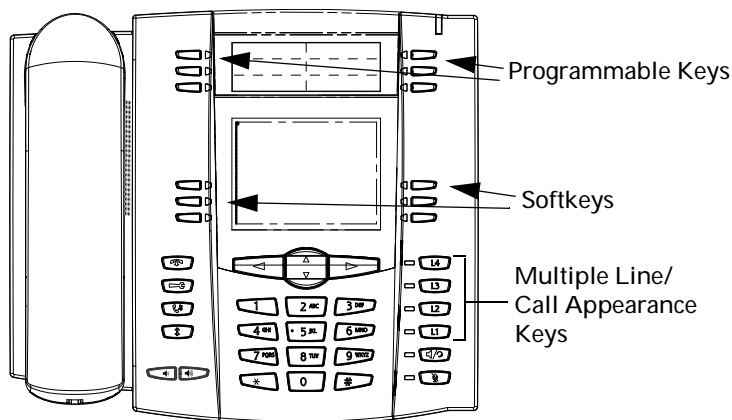

Multiple Line and Call Appearances

The 6755i has 4 hard line/call appearance buttons each with a corresponding status light.

These line/call appearance buttons and lights can represent physical lines, calls for your extension or calls from a group that your extension is part of. By pressing a line/call appearance button, you connect to the line or a call it represents. The line/call appearance light indicates the status of that line or call. When the phone is taken off-hook, the phone automatically selects a line for you.

Line/Call Appearance Light Behavior	Line/Call Appearance Status
Off	Idle line or no call activity
Light flashes quickly	Ringing
Light is solid	Connected
Light flashes slowly	Hold

When you have more than one call, you can use the left and right navigation buttons (3 and 4) to scroll left and right to the different call information. Icons 3 and 4 appear if there is call information either left, right or both sides of the current information you are viewing.

The display shows which line the call information is referring to (L1, L2, L3, L4, etc.), the Caller ID information (name and number, if available), the call status (**Connected**, **Ring**, **Hold**, etc.) and the timer specific to that call.

Softkeys and Programmable Keys

Your 6755i has 6 multi-functional top programmable keys and 6 multi-functional bottom softkeys:

- **6 Top Keys:** programmable hard keys (up to 6 programmable functions; the following illustration shows the default functions)
- **6 Bottom Keys:** programmable state-based softkeys (up to 20 programmable functions).

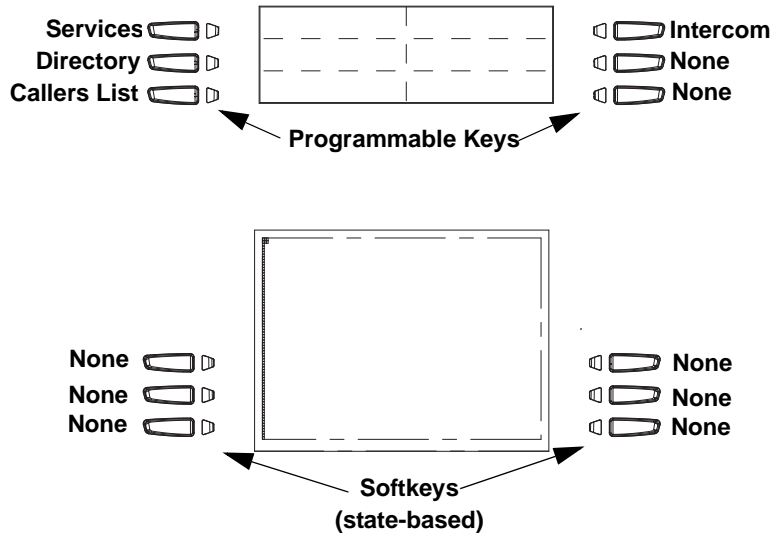

Note: If a M670i or M675i Expansion Module(s) is attached to the phone, you can configure up to an additional 36 softkeys on each M670i Expansion Module and up to 60 softkeys on each M675i Expansion Module. (The 6755i IP Phone allows up to 3 expansion modules on each phone). For more information about expansion modules, see [“Model M670i and M675i Expansion Modules”](#) on page 250.

You can use the Aastra Web UI only, to configure key functions.

The following table lists the functions you can set on the programmable keys and softkeys and provides a description for each function.

Key Function	Description
None	Indicates no setting for the key.
Line	Indicates the key is configured for line use.
Speeddial	Indicates the key is configured for speeddial use. You can also configure a prefix for a speeddial number.
Do Not Disturb	Indicates the key is configured for "do not disturb" on the phone.
Busy Lamp Field (BLF)	Indicates the key is configured for Busy Lamp Field (BLF) use. User can dial out on a BLF configured key. (Maximum of 50 BLFs allowed on M670i Expansion Module.)
BLF List	Indicates the key is configured for BLF list use. User can dial out on a BLF List configured key.
Auto Call Distribution (ACD)	(For Sylanro Servers) Indicates the key is configured to allow the Sylanro server to distribute calls from a queue to registered IP phone users (agents).
Directed Call Pickup (DCP)/ Group Call Pickup (GCP)	(For Sylanro Servers) Indicates the key is configured to allow you to intercept - or pickup - a call on a monitored extension(s).
XML	Indicates the key is configured to accept an XML application for accessing customized XML services. You can also specify an XML key URL for this option.
Flash	Indicates the key is set to generate a flash event when it is pressed on the 6755i. The IP phone generates flash events only when a call is connected and there is an active RTP stream (for example, when the call is not on hold).
Sprecode	Indicates the key is configured to automatically activate specific services offered by the server. For example, if the sprecode value of *82 is configured, then by pressing the Sprecode key, *82 automatically activates a service provided by the server. Contact your System Administrator for available services.
Park	Indicates the key is configured to park incoming calls when pressed.
Pickup	Indicates the key is configured to pick up parked calls when pressed.
Last Call Return (lcr)	Indicates the key is configured for "last call return" when pressed.
Call Forward	Indicates the key is configured as a Call Forward key. When pressed, the IP Phone UI displays the Call Forward menus.
BLF/Xfer	Indicates the key is configured as a simplified BLF key and a transfer key. You can use this key to perform the BLF function, or you can use it as a transfer key to transfer calls.
Speeddial/Xfer	Indicates the key is configured as a simplified speeddial key and a transfer key. You can use this key to perform speeddial functions, or you can use it as a transfer key to transfer calls.
Speeddial/Conf	Indicates the key is configured as a speeddial key and a conference key. You can use this key to speeddial from within a conference call, and add the new call directly to the conference.

Key Function	Description
Services (Key 1 on programmable keys by default)	Indicates the key is set to access Services, such as, Directory List, Callers List, Voicemail, or any other XML applications set up by your System Administrator.
Directory (Key 2 on programmable keys by default)	Indicates the key is configured to access the Directory List.
Callers List (Key 3 on programmable keys by default)	Indicates the key is configured to access the Callers List.
Intercom (Key 4 on programmable keys by default)	Indicates the key is configured to be used for intercom calls.
Phone Lock	Indicates the key is configured as a phone lock key, allowing you to press this key to lock/unlock the phone.
Paging	Indicates the key is configured as a Paging key. When pressed, the phone can send Real Time Transport Protocol (RTP) streams from a pre-configured multicast address without involving SIP signaling. You can also receive RTP streams from pre-configured multicast addresses (can specify up to 5 addresses) using the "Paging Listen Addresses" at the path, Basic Settings->Preferences->Group Paging RTP Settings in the Aastra Web UI. For more information about setting this parameter, see "Group RTP Paging (receives RTP streams)" on page 235.
Empty	Indicates the key has no function assigned.

Keys can also be set up to quickly to access features such as Call Return (*69) or Voicemail.



Note: Quick access features like Call Return and Voicemail must first be configured on your PBX in order to work on your phone. See your System Administrator for more information.

The following paragraphs describe how to configure each function listed in the previous table.

State-Based Softkeys (Bottom Keys only)

On the 6755i bottom softkeys, you can configure a specific state to display when a softkey is being used.

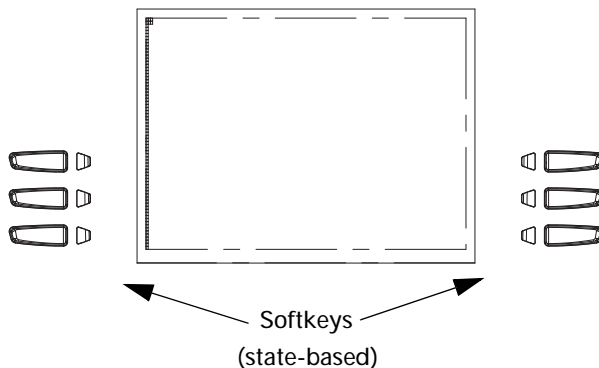

The following table describes the states available to configure for the softkeys.

State	Description
idle	The phone is not being used.
connected	The current line is in an active call (or the call is on hold).
incoming	The phone is ringing.
outgoing	The user is dialing a number, or the far-end is ringing.
busy	The current line is busy because the line is in use or the line is set as "Do Not Disturb".

The following table identifies the applicable default states for each softkey type on the IP phone.

Softkey Type	Default States
None	All states disabled.
Line	idle, connected, incoming, outgoing, busy
Speeddial	idle, connected, incoming, outgoing, busy
DND	idle, connected, incoming, outgoing, busy
BLF	idle, connected, incoming, outgoing, busy
BLF List	idle, connected, incoming, outgoing, busy
Auto Call Distribution (ACD)	idle
Directed Call Pickup (DCP)	idle, connected, incoming, outgoing, busy
Group Call Pickup (GCP)	
XML	idle, connected, incoming, outgoing, busy
Flash	All states disabled.
Sprecode	connected
Park	connected
Pickup	idle, outgoing

Softkey Type	Default States
Last Call Return	idle, connected, incoming, outgoing, busy
Call Forward	idle, connected, incoming, outgoing, busy
BLF/Xfer	idle, connected, incoming, outgoing, busy
Speeddial/Xfer	idle, connected, incoming, outgoing, busy
Speeddial/Conf	idle, connected, incoming, outgoing, busy
Services	idle, connected, incoming, outgoing, busy
Directory	idle, connected, incoming, outgoing, busy
Callers List	idle, connected, incoming, outgoing, busy
Intercom	idle, connected, incoming, outgoing, busy
Phone Lock	All states disabled.
Paging	All states disabled.
Empty	idle, connected, incoming, outgoing, busy

In the Aastra Web UI, the operational states for each softkey display enabled. To disable a state, you uncheck the box for that state.

Key Display Behavior

On the 6755i IP Phone, you can configure up to 20 functions on the softkeys. If you have no softkeys configured on the IP Phone, and you assign softkey functions to higher number keys in the Aastra Web UI, the key functions automatically appear in the first available position on the LCD display.

For example, if softkeys 1 through 20 are set to "**None**", and you set softkey 12 as the following:

Type: speeddial

Label: LAB

Value: 3456

after saving the settings, the "LAB" label actually appears in position 1 of the LCD. A softkey function of "**none**" does not display on the idle screen at all.

The following illustrations show the configuration of Key 12 and how that key displays on the phone.

Softkeys Configuration										
Key	Type	Label	Value	Line	Idle	Connected	Incoming	Outgoing	Busy	
1	WebApps			1	<input checked="" type="checkbox"/>	<input checked="" type="checkbox"/>	<input checked="" type="checkbox"/>	<input checked="" type="checkbox"/>	<input checked="" type="checkbox"/>	<input checked="" type="checkbox"/>
2	None			1	<input checked="" type="checkbox"/>	<input checked="" type="checkbox"/>	<input checked="" type="checkbox"/>	<input checked="" type="checkbox"/>	<input checked="" type="checkbox"/>	<input checked="" type="checkbox"/>
3	None			1	<input checked="" type="checkbox"/>	<input checked="" type="checkbox"/>	<input checked="" type="checkbox"/>	<input checked="" type="checkbox"/>	<input checked="" type="checkbox"/>	<input checked="" type="checkbox"/>
4	None			1	<input checked="" type="checkbox"/>	<input checked="" type="checkbox"/>	<input checked="" type="checkbox"/>	<input checked="" type="checkbox"/>	<input checked="" type="checkbox"/>	<input checked="" type="checkbox"/>
5	None			1	<input checked="" type="checkbox"/>	<input checked="" type="checkbox"/>	<input checked="" type="checkbox"/>	<input checked="" type="checkbox"/>	<input checked="" type="checkbox"/>	<input checked="" type="checkbox"/>
6	None			1	<input checked="" type="checkbox"/>	<input checked="" type="checkbox"/>	<input checked="" type="checkbox"/>	<input checked="" type="checkbox"/>	<input checked="" type="checkbox"/>	<input checked="" type="checkbox"/>
7	None			1	<input checked="" type="checkbox"/>	<input checked="" type="checkbox"/>	<input checked="" type="checkbox"/>	<input checked="" type="checkbox"/>	<input checked="" type="checkbox"/>	<input checked="" type="checkbox"/>
8	None			1	<input checked="" type="checkbox"/>	<input checked="" type="checkbox"/>	<input checked="" type="checkbox"/>	<input checked="" type="checkbox"/>	<input checked="" type="checkbox"/>	<input checked="" type="checkbox"/>
9	None			1	<input checked="" type="checkbox"/>	<input checked="" type="checkbox"/>	<input checked="" type="checkbox"/>	<input checked="" type="checkbox"/>	<input checked="" type="checkbox"/>	<input checked="" type="checkbox"/>
10	None			1	<input checked="" type="checkbox"/>	<input checked="" type="checkbox"/>	<input checked="" type="checkbox"/>	<input checked="" type="checkbox"/>	<input checked="" type="checkbox"/>	<input checked="" type="checkbox"/>
11	None			1	<input checked="" type="checkbox"/>	<input checked="" type="checkbox"/>	<input checked="" type="checkbox"/>	<input checked="" type="checkbox"/>	<input checked="" type="checkbox"/>	<input checked="" type="checkbox"/>
12	Speeddial	LAB	3456	1	<input checked="" type="checkbox"/>	<input checked="" type="checkbox"/>	<input checked="" type="checkbox"/>	<input checked="" type="checkbox"/>	<input checked="" type="checkbox"/>	<input checked="" type="checkbox"/>
13	None			1	<input checked="" type="checkbox"/>	<input checked="" type="checkbox"/>	<input checked="" type="checkbox"/>	<input checked="" type="checkbox"/>	<input checked="" type="checkbox"/>	<input checked="" type="checkbox"/>
14	None			1	<input checked="" type="checkbox"/>	<input checked="" type="checkbox"/>	<input checked="" type="checkbox"/>	<input checked="" type="checkbox"/>	<input checked="" type="checkbox"/>	<input checked="" type="checkbox"/>
15	None			1	<input checked="" type="checkbox"/>	<input checked="" type="checkbox"/>	<input checked="" type="checkbox"/>	<input checked="" type="checkbox"/>	<input checked="" type="checkbox"/>	<input checked="" type="checkbox"/>
16	None			1	<input checked="" type="checkbox"/>	<input checked="" type="checkbox"/>	<input checked="" type="checkbox"/>	<input checked="" type="checkbox"/>	<input checked="" type="checkbox"/>	<input checked="" type="checkbox"/>
17	None			1	<input checked="" type="checkbox"/>	<input checked="" type="checkbox"/>	<input checked="" type="checkbox"/>	<input checked="" type="checkbox"/>	<input checked="" type="checkbox"/>	<input checked="" type="checkbox"/>
18	None			1	<input checked="" type="checkbox"/>	<input checked="" type="checkbox"/>	<input checked="" type="checkbox"/>	<input checked="" type="checkbox"/>	<input checked="" type="checkbox"/>	<input checked="" type="checkbox"/>
19	None			1	<input checked="" type="checkbox"/>	<input checked="" type="checkbox"/>	<input checked="" type="checkbox"/>	<input checked="" type="checkbox"/>	<input checked="" type="checkbox"/>	<input checked="" type="checkbox"/>
20	None			1	<input checked="" type="checkbox"/>	<input checked="" type="checkbox"/>	<input checked="" type="checkbox"/>	<input checked="" type="checkbox"/>	<input checked="" type="checkbox"/>	<input checked="" type="checkbox"/>

Key 12 configured as a speedial

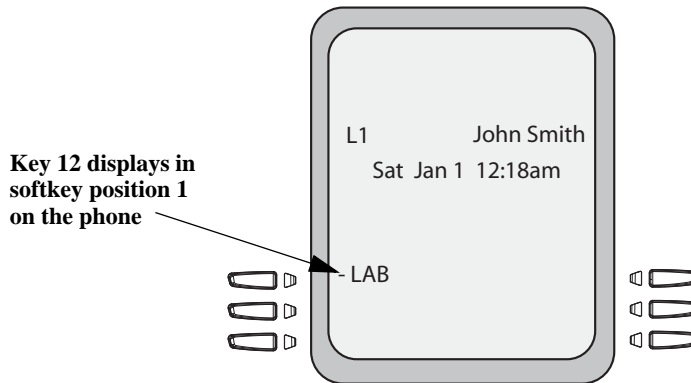

Line Key

You can set a programmable key or softkey to act as a line/call appearance key on the 6755i. This key acts as a line that behaves the same as a hard line key (L1, L2, L3, and L4). For more information about the behavior of line keys, see [“Multiple Line and Call Appearances”](#) on page 60.

If you configure line keys for the bottom softkeys, the status of the lines/call appearance keys appear on the phone’s display as shown in the following image.

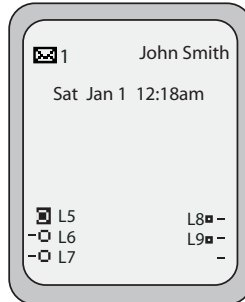

Icons next to the softkeys on the phone’s display indicate the status for that line or call. The following table provides a description for each icon.

Softkey Line/Call Appearance Lights			
Activity	Light	Icon	Definition
Idle	Solid	■	There is no call activity for the line/call appearance softkey.
Connected	Solid	□	A call is connected to your phone on this line/call appearance softkey. The equivalent on a line/call appearance hard key is a solid green light.
Ringing	Flashing	◻	A call is ringing at your phone on this line/call appearance softkey. The equivalent on a line/call appearance hard key is a fast flashing green light.
On Hold	Flashing	◼	A call is on hold on your phone on this line/call appearance softkey. The equivalent on a line/call appearance hard key is a slow flashing green light.

Depending on how the phone has been configured, the maximum number of total line/call appearances that can be configured is 9 (4 line/call appearance hard keys plus 5 softkeys or programmable keys). If all line/call appearances have been set up between two different numbers, a total of 8 lines can be configured.

This means that when all line/call appearances are in use, 1 call is connected while the rest are on hold. No further outgoing or incoming calls can be made until one of the line/call appearances becomes available.

In active states, such as ringing, conference, connected, etc., all softkeys disappear except softkeys that have been set up as line/call appearances, and any context dependent softkeys required for the active state, such as the **Drop** softkey in the connected state. Typically, context dependent softkeys appear in the top left position and all line/call appearance softkeys appear in the remaining positions.



Note: In some situations, such as during a conference call, the line/call appearance softkeys may overwrite some of the context dependent softkeys. In this case, instead of the **Previous** and **Next** softkeys, up or down icons, 5 and 2 appear on the display. By using the 5 and 2 navigation keys, you can access the same functionality as the Previous and Next softkeys.

You use the Aastra Web UI to set a programmable key or softkey as a line.

Configuring a Line Key

You can set a key as an additional line on the 6755i. The key acts as a line that behaves the same as a hard line key. For more information about the behavior of line keys, see “[Multiple Line and Call Appearances](#)” on [page 60](#).

You use the Aastra Web UI to set a key as a line.



Aastra Web UI

Use the following procedure to set a key to function as a line. The procedure shows the softkey screens as an example.

1. Click on **Operation->Softkeys and XML**.
or
Click on **Operation->Programmable Keys**.
or
Click on **Operation->Expansion Module <N>**.

Key	Type	Label	Value	Line	Idle	Connected	Incoming	Outgoing	Busy
1	WebApps			global	<input checked="" type="checkbox"/>	<input checked="" type="checkbox"/>	<input checked="" type="checkbox"/>	<input checked="" type="checkbox"/>	<input checked="" type="checkbox"/>
2	None			1	<input checked="" type="checkbox"/>	<input checked="" type="checkbox"/>	<input checked="" type="checkbox"/>	<input checked="" type="checkbox"/>	<input checked="" type="checkbox"/>
3	None			1	<input checked="" type="checkbox"/>	<input checked="" type="checkbox"/>	<input checked="" type="checkbox"/>	<input checked="" type="checkbox"/>	<input checked="" type="checkbox"/>
4	None			1	<input checked="" type="checkbox"/>	<input checked="" type="checkbox"/>	<input checked="" type="checkbox"/>	<input checked="" type="checkbox"/>	<input checked="" type="checkbox"/>
5	None			1	<input checked="" type="checkbox"/>	<input checked="" type="checkbox"/>	<input checked="" type="checkbox"/>	<input checked="" type="checkbox"/>	<input checked="" type="checkbox"/>
6	None			1	<input checked="" type="checkbox"/>	<input checked="" type="checkbox"/>	<input checked="" type="checkbox"/>	<input checked="" type="checkbox"/>	<input checked="" type="checkbox"/>
7	None			1	<input checked="" type="checkbox"/>	<input checked="" type="checkbox"/>	<input checked="" type="checkbox"/>	<input checked="" type="checkbox"/>	<input checked="" type="checkbox"/>
8	None			1	<input checked="" type="checkbox"/>	<input checked="" type="checkbox"/>	<input checked="" type="checkbox"/>	<input checked="" type="checkbox"/>	<input checked="" type="checkbox"/>
9	None			1	<input checked="" type="checkbox"/>	<input checked="" type="checkbox"/>	<input checked="" type="checkbox"/>	<input checked="" type="checkbox"/>	<input checked="" type="checkbox"/>
10	None			1	<input checked="" type="checkbox"/>	<input checked="" type="checkbox"/>	<input checked="" type="checkbox"/>	<input checked="" type="checkbox"/>	<input checked="" type="checkbox"/>
11	None			1	<input checked="" type="checkbox"/>	<input checked="" type="checkbox"/>	<input checked="" type="checkbox"/>	<input checked="" type="checkbox"/>	<input checked="" type="checkbox"/>
12	None			1	<input checked="" type="checkbox"/>	<input checked="" type="checkbox"/>	<input checked="" type="checkbox"/>	<input checked="" type="checkbox"/>	<input checked="" type="checkbox"/>
13	None			1	<input checked="" type="checkbox"/>	<input checked="" type="checkbox"/>	<input checked="" type="checkbox"/>	<input checked="" type="checkbox"/>	<input checked="" type="checkbox"/>
14	None			1	<input checked="" type="checkbox"/>	<input checked="" type="checkbox"/>	<input checked="" type="checkbox"/>	<input checked="" type="checkbox"/>	<input checked="" type="checkbox"/>
15	None			1	<input checked="" type="checkbox"/>	<input checked="" type="checkbox"/>	<input checked="" type="checkbox"/>	<input checked="" type="checkbox"/>	<input checked="" type="checkbox"/>
16	None			1	<input checked="" type="checkbox"/>	<input checked="" type="checkbox"/>	<input checked="" type="checkbox"/>	<input checked="" type="checkbox"/>	<input checked="" type="checkbox"/>
17	None			1	<input checked="" type="checkbox"/>	<input checked="" type="checkbox"/>	<input checked="" type="checkbox"/>	<input checked="" type="checkbox"/>	<input checked="" type="checkbox"/>
18	None			1	<input checked="" type="checkbox"/>	<input checked="" type="checkbox"/>	<input checked="" type="checkbox"/>	<input checked="" type="checkbox"/>	<input checked="" type="checkbox"/>
19	None			1	<input checked="" type="checkbox"/>	<input checked="" type="checkbox"/>	<input checked="" type="checkbox"/>	<input checked="" type="checkbox"/>	<input checked="" type="checkbox"/>
20	None			1	<input checked="" type="checkbox"/>	<input checked="" type="checkbox"/>	<input checked="" type="checkbox"/>	<input checked="" type="checkbox"/>	<input checked="" type="checkbox"/>

Services

XML Application URI:

XML Application Title:

BLF List URI:

Softkeys

2. Select from "Key 1" through "Key 20".
3. In the "Type" field, select **Line** to apply to the key.
4. In the "Label" field, enter a label to apply to this key.
5. In the "Line" field, select a line to apply to this key.
Valid values are **5** through **9**.
6. In the state fields, check (enable) or uncheck (disable) the states you want to apply to this softkey.

Programmable Keys

7. Select from "**Key 1**" through "**Key 6**"
8. In the "**Line**" field, select a line to apply to this key.
Valid values are **5** through **9**.

Expansion Module Keys

9. Select from "**Key 1**" through "**Key 36**" (M670i)
or
Select from "**Key 1**" through "**Key 60**" (M675i)
10. In the "**Line**" field, select a line to apply to this key.
Valid values are **5** through **9**.
11. (M675i) In the "**Label**" field, enter a label to apply to this key.
12. Click  to save your changes.

Speeddial Key

The normal function of the speeddial option allows you to dial a number quickly by pressing a key configured for speeddialing. You can program the keys on the 6755i to speeddial outside numbers, dial directly to another person's line or extension, or set up to quickly access features such as Caller ID (*69), Voicemail.

The speeddial function can be set using the IP Phone UI or the Aastra Web UI.



Note: You can use a speeddial key while on an active call by placing the active call on hold first, and then pressing the speeddial key.

You can create speeddial keys using any of the following methods:

- Using the Aastra Web UI at the paths:
 - *Operation->Softkeys and XML*
 - *Operation->Programmable Keys*
 - *Operation->Expansion Module Keys*
- Using the IP Phone UI at the path, *Options->Preferences->Speed Dial Edit*
- By pressing and holding a programmable key, softkey, keypad key, or expansion module key.

Speeddial Prefix

The speeddial feature also allows you to specify a preset string of numbers followed by a “+” that the phone dials automatically after pressing the speeddial key. You can use this feature for numbers that contain long prefixes.

For example, if you had the following speeddial configuration in the Aastra Web UI:

Access levelKey 1

Type=speeddial
Label=Europe Office
Value=1234567+
Line=2

then, after you press key 1 on the phone, the prefix number displays on the phone screen. The phone proceeds to dial the prefix number automatically and pauses for you to enter the remaining phone number using the keypad on the phone.

You can save up to 30 speeddial numbers on the 6755i.

Use the following procedures to set speeddial on the 6755i IP phone.

Press-and-Hold to Create a Speeddial (applicable to programmable keys, softkeys, keypad keys, expansion module keys)



IP Phone UI

Pressing and holding down a programmable key, softkey, keypad key, or expansion module key on the phone initiates a speeddial feature.



Note: When creating a speeddial key from the IP Phone UI, you must select a programmable key, softkey, keypad key, or expansion module key that has no preassigned function (key must be set to **None** or **Empty**.) If you press and hold a keypad key that is already configured as a speeddial, the speeddial information displays on the screen for you to edit.

1. Press a programmable key, softkey, keypad key, or expansion module key for 3 seconds. The following screen displays:



Note: You can press the "Cancel" softkey at anytime during the speeddial programming to cancel and not save the speeddial information.

2. In the "**Enter Name:**" field, enter a name to apply to the speeddial key. Use the keypad keys to enter the name. Continue to press the keypad keys to access the next letter for that key (i.e. press **2** three times to access **C**). Press **4** to move to the next space, or wait for the cursor to automatically advance to the next position. To insert a space between letters, press **4**. To backspace and erase a mistake, press the **Backspace** softkey.



Note: The phone automatically uses an uppercase letter for the first letter of each word and a lowercase letter for all subsequent letters in the word. If necessary, use the "**ABC 4**" softkey to specify uppercase letters or lowercase letters when entering the name.

You can enter up to 16 letters in the "Enter Name:" field.
Press the **2** key to move to the next field.

3. In the "**Enter Number:**" field, enter a number. for the speeddial key using the keypad keys. You can enter up to 16 numbers in the "Enter Number:" field

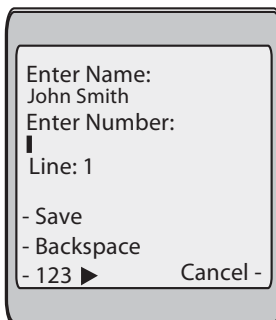

Note: When in the "**Enter Number:**" field, the phone automatically switches to the numbers softkey.

Press the 2 key to move to the next field.

4. In the "**Line:**" field, select a line to apply to the speeddial key.

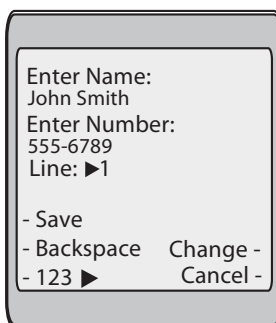

This is the line that the phone opens to dial the number after you press the speeddial key. By default, the phone uses Line 1 for the speeddial key. If you want to use a different line, press the "**Change**" key, or press the 4 key to select another line.

5. Press the "**Save**" softkey to save the speeddial information to the speeddial key you selected.



Note: To delete or remove a speeddial configuration from the phone, you can press the **Remove** key.

Creating a Speeddial Using the Speed Dial Edit Option

You can use the IP Phone UI at the path, *Options->Preferences->Speeddial Edit*, to create a speeddial key.

IP Phone UI

1. Press  on the phone to enter the Options List.
2. Select **Preferences** and press **Select**.
3. Select **Speed Dial Edit** and press **Select**.

The following prompt displays:
"Press SD button"

All current speeddial key LEDs flash RED (for softkeys, programmable keys and expansion module keys). All other function key LEDs turn off, during this process. After you press a speeddial key for editing, the phone restores all key LEDs to their previous state.



Note: If you select a key that is currently set as a speeddial key, the speeddial information displays for you to edit.

4. Press a non-configured softkey, programmable key, keypad key, or expansion module key.
The following screen displays:

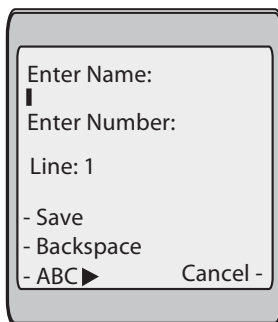

Enter Name:
|
Enter Number:
Line: 1
- Save
- Backspace
- ABC ▶ Cancel -



Note: You can press the "Cancel" softkey at anytime during the speeddial programming to cancel and not save the speeddial information.

5. In the "Enter Name:" field, enter a name to apply to the speeddial key.
Use the keypad keys to enter the name. Continue to press the keypad keys to access the next letter for that key (i.e. press **2** three times to access **C**). Press **4** to move to the next space, or wait for the cursor to automatically advance to the next position. To insert a space between letters, press **4**. To backspace and erase a mistake, press the **Backspace** softkey.



Note: The phone automatically uses an uppercase letter for the first letter of each word and a lowercase letter for all subsequent letters in the word. If necessary, use the "ABC 4" softkey to specify uppercase letters or lowercase letters when entering the name.

You can enter up to 16 letters in the "Enter Name:" field.
Press the 2 key to move to the next field.

- In the "**Enter Number:**" field, enter a number. for the speeddial key using the keypad keys.
You can enter up to 16 numbers in the "Enter Number:" field

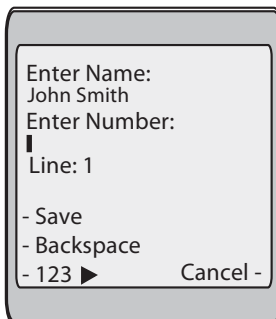

Note: When in the "Enter Number:" field, the phone automatically switches to the numbers softkey.

Press the 2 key to move to the next field.

- In the "**Line:**" field, select a line to apply to the speeddial key.

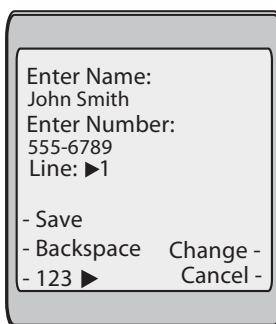

This is the line that the phone opens to dial the number after you press the speeddial key. By default, the phone uses Line 1 for the speeddial key. If you want to use a different line, press the "**Change**" key, or press the 4 key to select another line.

- Press the "**Save**" softkey to save the speeddial information to the speeddial key you selected.



Note: To delete or remove a speeddial configuration from the phone, you can press the **Remove** key.

Creating a Speeddial Key Using the Sofkeys, Programmable Keys, or Expansion Module Keys



Aastra Web UI

Use the following procedure to set a key to function as a speeddial. The procedure shows the softkey screens as an example.

1. Click on **Operation->Softkeys and XML**.
or
Click on **Operation->Programmable Keys**.
or
Click on **Operation->Expansion Module <N>**.

Status		Softkeys Configuration									
System Information		Key	Type	Label	Value	Line	Idle	Connected	Incoming	Outgoing	Busy
Operation		1	WebApps			global	<input checked="" type="checkbox"/>	<input checked="" type="checkbox"/>	<input checked="" type="checkbox"/>	<input checked="" type="checkbox"/>	<input checked="" type="checkbox"/>
User Password		2	None			1	<input checked="" type="checkbox"/>	<input checked="" type="checkbox"/>	<input checked="" type="checkbox"/>	<input checked="" type="checkbox"/>	<input checked="" type="checkbox"/>
Phone Lock		3	None			1	<input checked="" type="checkbox"/>	<input checked="" type="checkbox"/>	<input checked="" type="checkbox"/>	<input checked="" type="checkbox"/>	<input checked="" type="checkbox"/>
Softkeys and XML		4	None			1	<input checked="" type="checkbox"/>	<input checked="" type="checkbox"/>	<input checked="" type="checkbox"/>	<input checked="" type="checkbox"/>	<input checked="" type="checkbox"/>
Programmable Keys		5	None			1	<input checked="" type="checkbox"/>	<input checked="" type="checkbox"/>	<input checked="" type="checkbox"/>	<input checked="" type="checkbox"/>	<input checked="" type="checkbox"/>
Keypad Speed Dial		6	None			1	<input checked="" type="checkbox"/>	<input checked="" type="checkbox"/>	<input checked="" type="checkbox"/>	<input checked="" type="checkbox"/>	<input checked="" type="checkbox"/>
Directory		7	None			1	<input checked="" type="checkbox"/>	<input checked="" type="checkbox"/>	<input checked="" type="checkbox"/>	<input checked="" type="checkbox"/>	<input checked="" type="checkbox"/>
Reset		8	None			1	<input checked="" type="checkbox"/>	<input checked="" type="checkbox"/>	<input checked="" type="checkbox"/>	<input checked="" type="checkbox"/>	<input checked="" type="checkbox"/>
Basic Settings		9	None			1	<input checked="" type="checkbox"/>	<input checked="" type="checkbox"/>	<input checked="" type="checkbox"/>	<input checked="" type="checkbox"/>	<input checked="" type="checkbox"/>
Preferences		10	None			1	<input checked="" type="checkbox"/>	<input checked="" type="checkbox"/>	<input checked="" type="checkbox"/>	<input checked="" type="checkbox"/>	<input checked="" type="checkbox"/>
Account Configuration		11	None			1	<input checked="" type="checkbox"/>	<input checked="" type="checkbox"/>	<input checked="" type="checkbox"/>	<input checked="" type="checkbox"/>	<input checked="" type="checkbox"/>
		12	None			1	<input checked="" type="checkbox"/>	<input checked="" type="checkbox"/>	<input checked="" type="checkbox"/>	<input checked="" type="checkbox"/>	<input checked="" type="checkbox"/>
		13	None			1	<input checked="" type="checkbox"/>	<input checked="" type="checkbox"/>	<input checked="" type="checkbox"/>	<input checked="" type="checkbox"/>	<input checked="" type="checkbox"/>
		14	None			1	<input checked="" type="checkbox"/>	<input checked="" type="checkbox"/>	<input checked="" type="checkbox"/>	<input checked="" type="checkbox"/>	<input checked="" type="checkbox"/>
		15	None			1	<input checked="" type="checkbox"/>	<input checked="" type="checkbox"/>	<input checked="" type="checkbox"/>	<input checked="" type="checkbox"/>	<input checked="" type="checkbox"/>
		16	None			1	<input checked="" type="checkbox"/>	<input checked="" type="checkbox"/>	<input checked="" type="checkbox"/>	<input checked="" type="checkbox"/>	<input checked="" type="checkbox"/>
		17	None			1	<input checked="" type="checkbox"/>	<input checked="" type="checkbox"/>	<input checked="" type="checkbox"/>	<input checked="" type="checkbox"/>	<input checked="" type="checkbox"/>
		18	None			1	<input checked="" type="checkbox"/>	<input checked="" type="checkbox"/>	<input checked="" type="checkbox"/>	<input checked="" type="checkbox"/>	<input checked="" type="checkbox"/>
		19	None			1	<input checked="" type="checkbox"/>	<input checked="" type="checkbox"/>	<input checked="" type="checkbox"/>	<input checked="" type="checkbox"/>	<input checked="" type="checkbox"/>
		20	None			1	<input checked="" type="checkbox"/>	<input checked="" type="checkbox"/>	<input checked="" type="checkbox"/>	<input checked="" type="checkbox"/>	<input checked="" type="checkbox"/>
		Services XML Application URI: <input type="text"/> XML Application Title: <input type="text"/> BLF List URI: <input type="text"/>									

Softkeys

2. Select from "**Key 1**" through "**Key 20**"
3. In the "**Type**" field, select **Speeddial** to apply to the key.
4. In the "**Label**" field, enter a label to apply to this key.
5. In the "**Value**" field, enter the phone number, extension, or speeddial prefix to apply to this key. If you enter a speeddial prefix, you must enter the "+" character at the end of the prefix number (for example, "123456+").
6. In the "**Line**" field, select a line to apply to this key. Valid values are **1** through **9**.
7. In the state fields, check (enable) or uncheck (disable) the states you want to apply to this softkey.

Programmable Keys

8. Select from "Key 1" through "Key 6",
9. In the "Type" field, select **Speeddial** to apply to the key.
10. In the "Value" field, enter the phone number, extension, or speeddial prefix to apply to this key. If you enter a speeddial prefix, you must enter the "+" character at the end of the prefix number (for example, "123456+").
11. In the "Line" field, select a line to apply to this key. Valid values are 1 through 9.

Expansion Module Keys

12. Select from "Key 1" through "Key 36" (M670i)
or
Select from "Key 1" through "Key 60" (M675i)
13. In the "Type" field, select **Speeddial** to apply to the key.
14. (M675i) In the "Label" field, enter a label to apply to this key.
15. In the "Value" field, enter the phone number, extension, or speeddial prefix to apply to this key. If you enter a speeddial prefix, you must enter the "+" character at the end of the prefix number (for example, "123456+").
16. In the "Line" field, select a line to apply to this key. Valid values are 1 through 9.
17. Click  to save your changes.

Creating Speeddial Key Using "Keypad Speeddial" in the Aastra Web UI

1. Click on **Operation->Keypad Speeddial**.

Key	Value
1	<input type="text"/>
2	<input type="text"/>
3	<input type="text"/>
4	<input type="text"/>
5	<input type="text"/>
6	<input type="text"/>
7	<input type="text"/>
8	<input type="text"/>
9	<input type="text"/>



2. Select from "Digit 1" through "Digit 9".
3. In the input box, enter the phone number, extension, or speeddial prefix to apply to this Digit key. If you enter a speeddial prefix, you must enter the "+" character at the end of the prefix number (for example, "123456+").
4. Click  to save your changes.

Editing Speedial Keys

On the 6755i, you can edit a speedial key using any of the following methods:

- Using the Aastra Web UI at the path:
 - Operation->Softkeys and XML
 - Operation->Programmable Keys
 - Operation->Expansion Module Keys
- Using the IP Phone UI at the path:
 - *Options->Preferences->Speed Dial Edit*

The following illustration shows the path in the 6755i IP Phone UI for editing a speedial key.

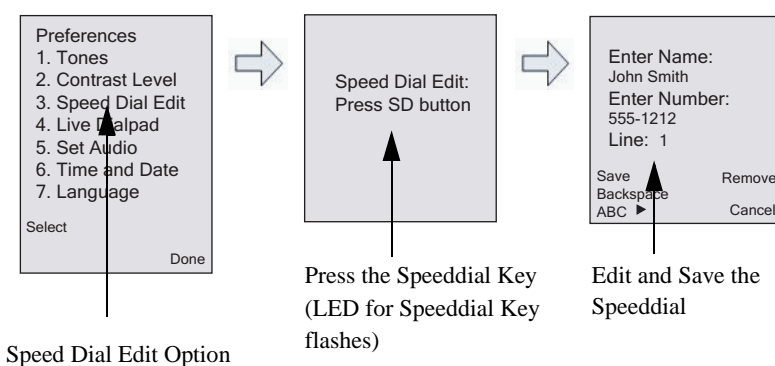

IP Phone UI

Use the following procedure to edit a speedial key from the IP Phone UI.



Note: *A speedial key must be already configured on the phone to edit the key.

1. Press  on the phone to enter the Options List.
2. Select **Preferences**.
3. Select **Speed Dial Edit**.

All current speedial key LEDs flash RED (for programmable keys and expansion module keys). All other function key LEDs turn off, during this process. After you press a speedial key for editing, the phone restores all key LEDs to their previous state.

4. Press a speeddial key you want to edit.

The speeddial edit screen displays.



Notes:

1. If a number on the keypad is setup as a speeddial key, pressing the applicable number in the speeddial editing process also displays the speeddial edit screen. The edit screen allows you to change the Speeddial Number and Line setting.
2. If you press a key that is NOT setup as a speeddial key, the phone displays an “**Invalid Key**” message. However, if you press-and-hold an empty digit key, programmable key, or expansion module key set to "NONE", it initiates the “Add a Speeddial Key” process allowing you to setup a new speeddial key. For more information, see “[Press-and-Hold to Create a Speeddial \(applicable to programmable keys, softkeys, keypad keys, expansion module keys\)](#)” on [page 72](#).

-
5. Edit the speeddial information as applicable and press SAVE.



Notes: :

1. You can cancel out of the speeddial editing process at any time without saving, by pressing the  key, or the **Cancel** key.
 2. You can delete a speeddial key by pressing the **Remove** key.
-

Editing a Speeddial on a Softkey, Programmable Key, or Expansion Module Key



Aastra Web UI

- Click on **Operation->Softkeys and XML**.
or
Click on **Operation->Programmable Keys**.
or
Click on **Operation->Expansion Module <N>**.

Key	Type	Label	Value	Line	Idle	Connected	Incoming	Outgoing	Busy
1	WebApps			global	<input checked="" type="checkbox"/>	<input checked="" type="checkbox"/>	<input checked="" type="checkbox"/>	<input checked="" type="checkbox"/>	<input checked="" type="checkbox"/>
2	None			1	<input checked="" type="checkbox"/>	<input checked="" type="checkbox"/>	<input checked="" type="checkbox"/>	<input checked="" type="checkbox"/>	<input checked="" type="checkbox"/>
3	None			1	<input checked="" type="checkbox"/>	<input checked="" type="checkbox"/>	<input checked="" type="checkbox"/>	<input checked="" type="checkbox"/>	<input checked="" type="checkbox"/>
4	None			1	<input checked="" type="checkbox"/>	<input checked="" type="checkbox"/>	<input checked="" type="checkbox"/>	<input checked="" type="checkbox"/>	<input checked="" type="checkbox"/>
5	None			1	<input checked="" type="checkbox"/>	<input checked="" type="checkbox"/>	<input checked="" type="checkbox"/>	<input checked="" type="checkbox"/>	<input checked="" type="checkbox"/>
6	None			1	<input checked="" type="checkbox"/>	<input checked="" type="checkbox"/>	<input checked="" type="checkbox"/>	<input checked="" type="checkbox"/>	<input checked="" type="checkbox"/>
7	None			1	<input checked="" type="checkbox"/>	<input checked="" type="checkbox"/>	<input checked="" type="checkbox"/>	<input checked="" type="checkbox"/>	<input checked="" type="checkbox"/>
8	None			1	<input checked="" type="checkbox"/>	<input checked="" type="checkbox"/>	<input checked="" type="checkbox"/>	<input checked="" type="checkbox"/>	<input checked="" type="checkbox"/>
9	None			1	<input checked="" type="checkbox"/>	<input checked="" type="checkbox"/>	<input checked="" type="checkbox"/>	<input checked="" type="checkbox"/>	<input checked="" type="checkbox"/>
10	None			1	<input checked="" type="checkbox"/>	<input checked="" type="checkbox"/>	<input checked="" type="checkbox"/>	<input checked="" type="checkbox"/>	<input checked="" type="checkbox"/>
11	None			1	<input checked="" type="checkbox"/>	<input checked="" type="checkbox"/>	<input checked="" type="checkbox"/>	<input checked="" type="checkbox"/>	<input checked="" type="checkbox"/>
12	None			1	<input checked="" type="checkbox"/>	<input checked="" type="checkbox"/>	<input checked="" type="checkbox"/>	<input checked="" type="checkbox"/>	<input checked="" type="checkbox"/>
13	None			1	<input checked="" type="checkbox"/>	<input checked="" type="checkbox"/>	<input checked="" type="checkbox"/>	<input checked="" type="checkbox"/>	<input checked="" type="checkbox"/>
14	None			1	<input checked="" type="checkbox"/>	<input checked="" type="checkbox"/>	<input checked="" type="checkbox"/>	<input checked="" type="checkbox"/>	<input checked="" type="checkbox"/>
15	None			1	<input checked="" type="checkbox"/>	<input checked="" type="checkbox"/>	<input checked="" type="checkbox"/>	<input checked="" type="checkbox"/>	<input checked="" type="checkbox"/>
16	None			1	<input checked="" type="checkbox"/>	<input checked="" type="checkbox"/>	<input checked="" type="checkbox"/>	<input checked="" type="checkbox"/>	<input checked="" type="checkbox"/>
17	None			1	<input checked="" type="checkbox"/>	<input checked="" type="checkbox"/>	<input checked="" type="checkbox"/>	<input checked="" type="checkbox"/>	<input checked="" type="checkbox"/>
18	None			1	<input checked="" type="checkbox"/>	<input checked="" type="checkbox"/>	<input checked="" type="checkbox"/>	<input checked="" type="checkbox"/>	<input checked="" type="checkbox"/>
19	None			1	<input checked="" type="checkbox"/>	<input checked="" type="checkbox"/>	<input checked="" type="checkbox"/>	<input checked="" type="checkbox"/>	<input checked="" type="checkbox"/>
20	None			1	<input checked="" type="checkbox"/>	<input checked="" type="checkbox"/>	<input checked="" type="checkbox"/>	<input checked="" type="checkbox"/>	<input checked="" type="checkbox"/>

Services

XML Application URI:

XML Application Title:

BLF List URI:

- Select the key configured for speeddial.
- In the **"Value"** field, edit the phone number, extension, or speeddial prefix to apply to this hard key. If you enter a speeddial prefix, you must enter the "+" character at the end of the prefix number (for example, "123456+").
- If required in the **"Line"** field, select a line for which to apply the speeddial to. Valid values are **1** through **9**.
- Click  to save your changes.



Note: You can delete a speeddial key by removing the information from the **"Value"** field.

Editing a Speeddial Key Using “Keypad Speeddial” in the Aastra Web UI



Aastra Web UI

1. Click on **Operation->Keypad Speeddial..**

Key	Value
1	<input type="text"/>
2	<input type="text"/>
3	<input type="text"/>
4	<input type="text"/>
5	<input type="text"/>
6	<input type="text"/>
7	<input type="text"/>
8	<input type="text"/>
9	<input type="text"/>

Save Settings

2. Select from "**Digit 1**" through "**Digit 9**".
3. In the input box, edit the phone number, extension, or speeddial prefix for this Digit key. If you enter a speeddial prefix, you must enter the "+" character at the end of the prefix number (for example, "123456+").
4. Click  to save your changes.

"Do not Disturb" (DND) Key

The IP phones have a feature you can enable called "Do not Disturb (DND)". The DND function allows you to turn "do not disturb" ON and OFF.



Note: You can configure DND using the Aastra Web UI only.

If DND is ON, callers calling into the phone hear a busy signal or a message, depending on how your System Administrator set up the configuration server. The second line on the screen of the IP phone shows when DND is set.

If the phone shares a line with other phones, only the phone that has DND configured is affected.

You can set DND on the keys using the Aastra Web UI only. DND is not configurable from the IP phone UI.

Configuring a DND Key



Aastra Web UI

Use the following procedure to set a key to function as "Do Not Disturb". The procedure shows the softkey screens as an example.

1. Click on **Operation->Softkeys and XML**.
or
Click on **Operation->Programmable Keys**.
or
Click on **Operation->Expansion Module <N>**.

Key	Type	Label	Value	Line	Idle	Connected	Incoming	Outgoing	Busy
1	WhatsApp			1	<input checked="" type="checkbox"/>	<input checked="" type="checkbox"/>	<input checked="" type="checkbox"/>	<input checked="" type="checkbox"/>	<input checked="" type="checkbox"/>
2	None			1	<input type="checkbox"/>	<input type="checkbox"/>	<input type="checkbox"/>	<input type="checkbox"/>	<input type="checkbox"/>
3	None			1	<input type="checkbox"/>	<input type="checkbox"/>	<input type="checkbox"/>	<input type="checkbox"/>	<input type="checkbox"/>
4	None			1	<input type="checkbox"/>	<input type="checkbox"/>	<input type="checkbox"/>	<input type="checkbox"/>	<input type="checkbox"/>
5	None			1	<input type="checkbox"/>	<input type="checkbox"/>	<input type="checkbox"/>	<input type="checkbox"/>	<input type="checkbox"/>
6	None			1	<input type="checkbox"/>	<input type="checkbox"/>	<input type="checkbox"/>	<input type="checkbox"/>	<input type="checkbox"/>
7	None			1	<input type="checkbox"/>	<input type="checkbox"/>	<input type="checkbox"/>	<input type="checkbox"/>	<input type="checkbox"/>
8	None			1	<input type="checkbox"/>	<input type="checkbox"/>	<input type="checkbox"/>	<input type="checkbox"/>	<input type="checkbox"/>
9	None			1	<input type="checkbox"/>	<input type="checkbox"/>	<input type="checkbox"/>	<input type="checkbox"/>	<input type="checkbox"/>
10	None			1	<input type="checkbox"/>	<input type="checkbox"/>	<input type="checkbox"/>	<input type="checkbox"/>	<input type="checkbox"/>
11	None			1	<input type="checkbox"/>	<input type="checkbox"/>	<input type="checkbox"/>	<input type="checkbox"/>	<input type="checkbox"/>
12	None			1	<input type="checkbox"/>	<input type="checkbox"/>	<input type="checkbox"/>	<input type="checkbox"/>	<input type="checkbox"/>
13	None			1	<input type="checkbox"/>	<input type="checkbox"/>	<input type="checkbox"/>	<input type="checkbox"/>	<input type="checkbox"/>
14	None			1	<input type="checkbox"/>	<input type="checkbox"/>	<input type="checkbox"/>	<input type="checkbox"/>	<input type="checkbox"/>
15	None			1	<input type="checkbox"/>	<input type="checkbox"/>	<input type="checkbox"/>	<input type="checkbox"/>	<input type="checkbox"/>
16	None			1	<input type="checkbox"/>	<input type="checkbox"/>	<input type="checkbox"/>	<input type="checkbox"/>	<input type="checkbox"/>
17	None			1	<input type="checkbox"/>	<input type="checkbox"/>	<input type="checkbox"/>	<input type="checkbox"/>	<input type="checkbox"/>
18	None			1	<input type="checkbox"/>	<input type="checkbox"/>	<input type="checkbox"/>	<input type="checkbox"/>	<input type="checkbox"/>
19	None			1	<input type="checkbox"/>	<input type="checkbox"/>	<input type="checkbox"/>	<input type="checkbox"/>	<input type="checkbox"/>
20	None			1	<input type="checkbox"/>	<input type="checkbox"/>	<input type="checkbox"/>	<input type="checkbox"/>	<input type="checkbox"/>

Services	
XML Application URI:	<input type="text"/>
XML Application Title:	<input type="text"/>
BLF List URI:	<input type="text"/>

Softkeys

2. Select from "**Key 1**" through "**Key 20**".
3. In the "**Type**" field, select **Do Not Disturb** to apply to the key.
4. In the state fields, check (enable) or uncheck (disable) the states you want to apply to this softkey.

Programmable Keys

5. Select from "**Key 1**" through "**Key 6**".
6. In the "**Type**" field, select **Do Not Disturb** to apply to the key.

Expansion Module Keys

7. Select from "**Key 1**" through "**Key 36**" (M670i)
or
Select from "**Key 1**" through "**Key 60**" (M675i)
8. In the "**Type**" field, select **Do Not Disturb** to apply to the key.
9. Click  to save your changes.

Busy Lamp Field (BLF) Key

The BLF feature on the IP phones allows a specific extension to be monitored for state changes. BLF monitors the status (busy or idle) of extensions on the IP phone.



Note: The BLF setting is applicable to the Asterisk server only.

Example

A Supervisor configures BLFs on his phone for monitoring the status of a worker's phone use (busy or idle). When the worker picks up his phone to make a call, a busy indicator on the Supervisor's phone shows that the worker's phone is in use and busy.

On the 6755i, the busy and idle indicators show on the IP phone screen display next to the key programmed for BLF functionality. When the monitored user is idle, an icon with the handset on-hook shows next to the BLF key. When the monitored user is on an active call, a small telephone icon is shown with the handset off-hook.



Note: You can also use a BLF configured key to dial out. Contact your System Administrator for more information

Configuring a BLF Key



Aastra Web UI

Use the following procedure to set a key to function as "BLF". The procedure shows the softkey screens as an example.

1. Click on **Operation->Softkeys and XML**.
or
Click on **Operation->Programmable Keys**.
or
Click on **Operation->Expansion Module <N>**.

Key	Type	Label	Value	Line	Idle	Connected	Incoming	Outgoing	Busy
1	WebApps			global	<input checked="" type="checkbox"/>	<input checked="" type="checkbox"/>	<input checked="" type="checkbox"/>	<input checked="" type="checkbox"/>	<input checked="" type="checkbox"/>
2	None			1	<input checked="" type="checkbox"/>	<input checked="" type="checkbox"/>	<input checked="" type="checkbox"/>	<input checked="" type="checkbox"/>	<input checked="" type="checkbox"/>
3	None			1	<input checked="" type="checkbox"/>	<input checked="" type="checkbox"/>	<input checked="" type="checkbox"/>	<input checked="" type="checkbox"/>	<input checked="" type="checkbox"/>
4	None			1	<input checked="" type="checkbox"/>	<input checked="" type="checkbox"/>	<input checked="" type="checkbox"/>	<input checked="" type="checkbox"/>	<input checked="" type="checkbox"/>
5	None			1	<input checked="" type="checkbox"/>	<input checked="" type="checkbox"/>	<input checked="" type="checkbox"/>	<input checked="" type="checkbox"/>	<input checked="" type="checkbox"/>
6	None			1	<input checked="" type="checkbox"/>	<input checked="" type="checkbox"/>	<input checked="" type="checkbox"/>	<input checked="" type="checkbox"/>	<input checked="" type="checkbox"/>
7	None			1	<input checked="" type="checkbox"/>	<input checked="" type="checkbox"/>	<input checked="" type="checkbox"/>	<input checked="" type="checkbox"/>	<input checked="" type="checkbox"/>
8	None			1	<input checked="" type="checkbox"/>	<input checked="" type="checkbox"/>	<input checked="" type="checkbox"/>	<input checked="" type="checkbox"/>	<input checked="" type="checkbox"/>
9	None			1	<input checked="" type="checkbox"/>	<input checked="" type="checkbox"/>	<input checked="" type="checkbox"/>	<input checked="" type="checkbox"/>	<input checked="" type="checkbox"/>
10	None			1	<input checked="" type="checkbox"/>	<input checked="" type="checkbox"/>	<input checked="" type="checkbox"/>	<input checked="" type="checkbox"/>	<input checked="" type="checkbox"/>
11	None			1	<input checked="" type="checkbox"/>	<input checked="" type="checkbox"/>	<input checked="" type="checkbox"/>	<input checked="" type="checkbox"/>	<input checked="" type="checkbox"/>
12	None			1	<input checked="" type="checkbox"/>	<input checked="" type="checkbox"/>	<input checked="" type="checkbox"/>	<input checked="" type="checkbox"/>	<input checked="" type="checkbox"/>
13	None			1	<input checked="" type="checkbox"/>	<input checked="" type="checkbox"/>	<input checked="" type="checkbox"/>	<input checked="" type="checkbox"/>	<input checked="" type="checkbox"/>
14	None			1	<input checked="" type="checkbox"/>	<input checked="" type="checkbox"/>	<input checked="" type="checkbox"/>	<input checked="" type="checkbox"/>	<input checked="" type="checkbox"/>
15	None			1	<input checked="" type="checkbox"/>	<input checked="" type="checkbox"/>	<input checked="" type="checkbox"/>	<input checked="" type="checkbox"/>	<input checked="" type="checkbox"/>
16	None			1	<input checked="" type="checkbox"/>	<input checked="" type="checkbox"/>	<input checked="" type="checkbox"/>	<input checked="" type="checkbox"/>	<input checked="" type="checkbox"/>
17	None			1	<input checked="" type="checkbox"/>	<input checked="" type="checkbox"/>	<input checked="" type="checkbox"/>	<input checked="" type="checkbox"/>	<input checked="" type="checkbox"/>
18	None			1	<input checked="" type="checkbox"/>	<input checked="" type="checkbox"/>	<input checked="" type="checkbox"/>	<input checked="" type="checkbox"/>	<input checked="" type="checkbox"/>
19	None			1	<input checked="" type="checkbox"/>	<input checked="" type="checkbox"/>	<input checked="" type="checkbox"/>	<input checked="" type="checkbox"/>	<input checked="" type="checkbox"/>
20	None			1	<input checked="" type="checkbox"/>	<input checked="" type="checkbox"/>	<input checked="" type="checkbox"/>	<input checked="" type="checkbox"/>	<input checked="" type="checkbox"/>

Services	
XML Application URI:	<input type="text"/>
XML Application Title:	<input type="text"/>
BLF List URI:	<input type="text"/>

Softkeys

2. Select from "**Key 1**" through "**Key 20**".
3. In the "**Type**" field, select **BLF** to apply to the key.
4. In the "**Label**" field, enter a label to apply to this key.
5. In the "**Value**" field, enter the phone number or extension you want to monitor.
6. In the "**Line**" field, select a line for which to apply this key. Valid values are:
 - **global**
 - **1 through 9**
7. In the state fields, check (enable) or uncheck (disable) the states you want to apply to this softkey.

Programmable Keys

8. Select from "**Key 1**" through "**Key 6**"
9. In the "**Value**" field, enter the phone number or extension you want to monitor.
10. In the "**Line**" field, select a line for which to apply this key. Valid values are:
 - **global**
 - **1** through **9**

Expansion Module Keys

11. Select from "**Key 1**" through "**Key 36**" (M670i)
or
Select from "**Key 1**" through "**Key 60**" (M675i)
12. In the "**Value**" field, enter the phone number or extension you want to monitor.
13. (M675i) In the "**Label**" field, enter a label to apply to this key.
14. In the "**Line**" field, select a line for which to apply this key. Valid values are:
 - **global**
 - **1** through **9**.
15. Click  to save your changes.

BLF List Key

(For use with the BroadSoft Broadworks Rel 13 or higher platform only).

The BLF\List feature on the IP phones is specifically designed to support the BroadSoft Broadworks Rel 13 Busy Lamp Field feature.

This feature allows the IP phone to subscribe to a list of monitored users defined through the BroadWorks web portal.



Note: Your System Administrator must have BLF List enabled on the BroadWorks Server. Contact your System Administrator for more information.

In addition to monitoring the idle and busy state, the BLF\List feature also supports the ringing state. When the monitored user is idle, there is a small telephone icon shown with the handset on-hook. When the monitored user is on an active call, a small telephone icon is shown with the handset off-hook.



Note: You can use a BLF\List configured key to dial out.

Example

A receptionist has a 6755i running Broadsoft firmware that subscribes to a list of extensions from the BroadWorks Application Server. On the 6755i, the key LEDs illuminate either flashing, solid, or turn off depending on the state of those extensions.



Note: The Broadworks BLF feature is not the same as the Broadworks Shared Call Appearance (SCA) feature and does not permit call control over the monitored extension.

Configuring a BLF List Key

The BLF List function can be configured on the 6755i using the Aastra Web UI only.

If you set a key to use BLF/List, you must also enter a **BLF List URI** at **Operation->Softkeys and XML->Services**. The BLF List URI is the name of the BLF list defined on the BroadSoft BroadWorks Busy Lamp field page for your particular user. For example, my480i-blf-list@as.broadworks.com. The value of the BLF\List URI parameter must match the list name configured. Otherwise, no values display on the 6755i screen and the feature is disabled.



Use the following procedure to set a key to function as "BLF List". The procedure shows the softkey screens as an example.

1. Click on **Operation->Softkeys and XML**.
or
Click on **Operation->Programmable Keys**.
or
Click on **Operation->Expansion Module <N>**.

Status		Softkeys Configuration									
System Information		Key	Type	Label	Value	Line	Idle	Connected	Incoming	Outgoing	Busy
Operation		1	WebApps			global	<input checked="" type="checkbox"/>	<input checked="" type="checkbox"/>	<input checked="" type="checkbox"/>	<input checked="" type="checkbox"/>	<input checked="" type="checkbox"/>
User Password		2	None			1	<input checked="" type="checkbox"/>	<input checked="" type="checkbox"/>	<input checked="" type="checkbox"/>	<input checked="" type="checkbox"/>	<input checked="" type="checkbox"/>
Phone Lock		3	None			1	<input checked="" type="checkbox"/>	<input checked="" type="checkbox"/>	<input checked="" type="checkbox"/>	<input checked="" type="checkbox"/>	<input checked="" type="checkbox"/>
Softkeys and XML		4	None			1	<input checked="" type="checkbox"/>	<input checked="" type="checkbox"/>	<input checked="" type="checkbox"/>	<input checked="" type="checkbox"/>	<input checked="" type="checkbox"/>
Programmable Keys		5	None			1	<input checked="" type="checkbox"/>	<input checked="" type="checkbox"/>	<input checked="" type="checkbox"/>	<input checked="" type="checkbox"/>	<input checked="" type="checkbox"/>
Keypad Speed Dial		6	None			1	<input checked="" type="checkbox"/>	<input checked="" type="checkbox"/>	<input checked="" type="checkbox"/>	<input checked="" type="checkbox"/>	<input checked="" type="checkbox"/>
Directory		7	None			1	<input checked="" type="checkbox"/>	<input checked="" type="checkbox"/>	<input checked="" type="checkbox"/>	<input checked="" type="checkbox"/>	<input checked="" type="checkbox"/>
Reset		8	None			1	<input checked="" type="checkbox"/>	<input checked="" type="checkbox"/>	<input checked="" type="checkbox"/>	<input checked="" type="checkbox"/>	<input checked="" type="checkbox"/>
Basic Settings		9	None			1	<input checked="" type="checkbox"/>	<input checked="" type="checkbox"/>	<input checked="" type="checkbox"/>	<input checked="" type="checkbox"/>	<input checked="" type="checkbox"/>
Preferences		10	None			1	<input checked="" type="checkbox"/>	<input checked="" type="checkbox"/>	<input checked="" type="checkbox"/>	<input checked="" type="checkbox"/>	<input checked="" type="checkbox"/>
Account Configuration		11	None			1	<input checked="" type="checkbox"/>	<input checked="" type="checkbox"/>	<input checked="" type="checkbox"/>	<input checked="" type="checkbox"/>	<input checked="" type="checkbox"/>
		12	None			1	<input checked="" type="checkbox"/>	<input checked="" type="checkbox"/>	<input checked="" type="checkbox"/>	<input checked="" type="checkbox"/>	<input checked="" type="checkbox"/>
		13	None			1	<input checked="" type="checkbox"/>	<input checked="" type="checkbox"/>	<input checked="" type="checkbox"/>	<input checked="" type="checkbox"/>	<input checked="" type="checkbox"/>
		14	None			1	<input checked="" type="checkbox"/>	<input checked="" type="checkbox"/>	<input checked="" type="checkbox"/>	<input checked="" type="checkbox"/>	<input checked="" type="checkbox"/>
		15	None			1	<input checked="" type="checkbox"/>	<input checked="" type="checkbox"/>	<input checked="" type="checkbox"/>	<input checked="" type="checkbox"/>	<input checked="" type="checkbox"/>
		16	None			1	<input checked="" type="checkbox"/>	<input checked="" type="checkbox"/>	<input checked="" type="checkbox"/>	<input checked="" type="checkbox"/>	<input checked="" type="checkbox"/>
		17	None			1	<input checked="" type="checkbox"/>	<input checked="" type="checkbox"/>	<input checked="" type="checkbox"/>	<input checked="" type="checkbox"/>	<input checked="" type="checkbox"/>
		18	None			1	<input checked="" type="checkbox"/>	<input checked="" type="checkbox"/>	<input checked="" type="checkbox"/>	<input checked="" type="checkbox"/>	<input checked="" type="checkbox"/>
		19	None			1	<input checked="" type="checkbox"/>	<input checked="" type="checkbox"/>	<input checked="" type="checkbox"/>	<input checked="" type="checkbox"/>	<input checked="" type="checkbox"/>
		20	None			1	<input checked="" type="checkbox"/>	<input checked="" type="checkbox"/>	<input checked="" type="checkbox"/>	<input checked="" type="checkbox"/>	<input checked="" type="checkbox"/>
		Services XML Application URI: <input type="text"/> XML Application Title: <input type="text"/> BLF List URI: <input type="text"/>									

Softkeys

2. Select from "**Key 1**" through "**Key 20**".
3. In the "**Type**" field, select "**BLF\List**" (BroadSoft BroadWorks).
4. In the "**Line**" field, select a line number that is actively registered to the appropriate SIP proxy you are using. Valid values are:
 - **global**
 - **1 through 9**



Note: The "Label" and "Value" field are not required. The BroadWorks BLF List name is configured in the "BLF List URI" field instead.

5. In the state fields, check (enable) or uncheck (disable) the states you want to apply to this softkey.
6. In the "**BLF List URI**" field, enter the name of the BLF list defined on the BroadSoft BroadWorks Busy Lamp field page for your particular user. For example, my6755i-blf-list@as.broadworks.com.



Note: Contact your System Administrator for the BLF List URI.

Programmable Keys

7. Select from "**Key 1**" through "**Key 6**"
8. In the "**Line**" field, select a line for which to apply this key. Valid values are:
 - **global**
 - **1 through 9**



Note: The "Value" field is not required. The BroadWorks BLF List name is configured in the "BLF List URI" field instead.

9. In the "**BLF List URI**" field, enter the name of the BLF list defined on the BroadSoft BroadWorks Busy Lamp field page for your particular user. For example, my6755i-blf-list@as.broadworks.com.



Note: Contact your System Administrator for the BLF List URI.

Expansion Module Keys

10. Select from "**Key 1**" through "**Key 36**" (M670i)
or
Select from "**Key 1**" through "**Key 60**" (M675i)
11. In the "**Line**" field, select a line for which to apply this key. Valid values are:
 - **global**
 - **1 through 9.**



Note: The "Value" field is not required. The BroadWorks BLF List name is configured in the "BLF List URI" field instead.

12. In the "**BLF List URI**" field, enter the name of the BLF list defined on the BroadSoft BroadWorks Busy Lamp field page for your particular user. For example, my6755i-blf-list@as.broadworks.com.



Note: Contact your System Administrator for the BLF List URI.

13. Click  to save your changes.

Automatic Call Distribution (ACD) Key (for Sylanro Servers)

The 6755i and any attached Expansion Modules support Automatic Call Distribution (ACD) for Sylanro servers. The ACD feature allows the Sylanro server to distribute calls from a queue to registered IP phone users (agents).

To use the ACD feature on an IP phone, you must first configure an ACD softkey, programmable key, or expansion module key. When you want to subscribe to a queue (in order to receive incoming calls), you press the ACD key and the IP phone UI prompts you to specify the following information:

- **User ID:** the phone number(s) used to login into the queue.
- **Password:** the password used to login to the queue.
- **Available/unavailable:** Shows the current status of the IP phone. Specifies if the IP phone user is available/unavailable to receive a call from the queue.



Note: Your System Administrator must provide you with your User ID and Password to access the applicable phone queue.

After creating an ACD key, you are ready to receive calls from a queue on the server. You must press the ACD key and then log in by entering your User ID and Password. An "Available" softkey displays allowing you to make your phone available to accept these calls.

When you are on an active call, or you miss a call, the server automatically changes the phone's status to unavailable. The server updates its database with this new information and no longer distributes calls to the phone. The phone remains in this "unavailable" state until:

- you make yourself "available" again by pressing the "Available" softkey.
- an ACD timer expires (set by your System Administrator).

You can also choose to manually change the phone status to unavailable by pressing the "Unavailable" softkey on the phone.



Note: It is recommended you configure no more than a single ACD softkey, programmable key, or expansion module key per IP phone.

Configuring an Automatic Call Distribution (ACD) Key



Aastra Web UI

Use the following procedure to configure ACD on the 6755i IP Phone. The procedure shows the softkey screens as an example.

1. Click on **Operation->Softkeys and XML**.
or
Click on **Operation->Programmable Keys**.
or
Click on **Operation->Expansion Module <N>**.

Key	Type	Label	Value	Line	Idle	Connected	Incoming	Outgoing	Busy
1	WebApps			global	<input checked="" type="checkbox"/>	<input checked="" type="checkbox"/>	<input checked="" type="checkbox"/>	<input checked="" type="checkbox"/>	<input checked="" type="checkbox"/>
2	None			1	<input checked="" type="checkbox"/>	<input checked="" type="checkbox"/>	<input checked="" type="checkbox"/>	<input checked="" type="checkbox"/>	<input checked="" type="checkbox"/>
3	None			1	<input checked="" type="checkbox"/>	<input checked="" type="checkbox"/>	<input checked="" type="checkbox"/>	<input checked="" type="checkbox"/>	<input checked="" type="checkbox"/>
4	None			1	<input checked="" type="checkbox"/>	<input checked="" type="checkbox"/>	<input checked="" type="checkbox"/>	<input checked="" type="checkbox"/>	<input checked="" type="checkbox"/>
5	None			1	<input checked="" type="checkbox"/>	<input checked="" type="checkbox"/>	<input checked="" type="checkbox"/>	<input checked="" type="checkbox"/>	<input checked="" type="checkbox"/>
6	None			1	<input checked="" type="checkbox"/>	<input checked="" type="checkbox"/>	<input checked="" type="checkbox"/>	<input checked="" type="checkbox"/>	<input checked="" type="checkbox"/>
7	None			1	<input checked="" type="checkbox"/>	<input checked="" type="checkbox"/>	<input checked="" type="checkbox"/>	<input checked="" type="checkbox"/>	<input checked="" type="checkbox"/>
8	None			1	<input checked="" type="checkbox"/>	<input checked="" type="checkbox"/>	<input checked="" type="checkbox"/>	<input checked="" type="checkbox"/>	<input checked="" type="checkbox"/>
9	None			1	<input checked="" type="checkbox"/>	<input checked="" type="checkbox"/>	<input checked="" type="checkbox"/>	<input checked="" type="checkbox"/>	<input checked="" type="checkbox"/>
10	None			1	<input checked="" type="checkbox"/>	<input checked="" type="checkbox"/>	<input checked="" type="checkbox"/>	<input checked="" type="checkbox"/>	<input checked="" type="checkbox"/>
11	None			1	<input checked="" type="checkbox"/>	<input checked="" type="checkbox"/>	<input checked="" type="checkbox"/>	<input checked="" type="checkbox"/>	<input checked="" type="checkbox"/>
12	None			1	<input checked="" type="checkbox"/>	<input checked="" type="checkbox"/>	<input checked="" type="checkbox"/>	<input checked="" type="checkbox"/>	<input checked="" type="checkbox"/>
13	None			1	<input checked="" type="checkbox"/>	<input checked="" type="checkbox"/>	<input checked="" type="checkbox"/>	<input checked="" type="checkbox"/>	<input checked="" type="checkbox"/>
14	None			1	<input checked="" type="checkbox"/>	<input checked="" type="checkbox"/>	<input checked="" type="checkbox"/>	<input checked="" type="checkbox"/>	<input checked="" type="checkbox"/>
15	None			1	<input checked="" type="checkbox"/>	<input checked="" type="checkbox"/>	<input checked="" type="checkbox"/>	<input checked="" type="checkbox"/>	<input checked="" type="checkbox"/>
16	None			1	<input checked="" type="checkbox"/>	<input checked="" type="checkbox"/>	<input checked="" type="checkbox"/>	<input checked="" type="checkbox"/>	<input checked="" type="checkbox"/>
17	None			1	<input checked="" type="checkbox"/>	<input checked="" type="checkbox"/>	<input checked="" type="checkbox"/>	<input checked="" type="checkbox"/>	<input checked="" type="checkbox"/>
18	None			1	<input checked="" type="checkbox"/>	<input checked="" type="checkbox"/>	<input checked="" type="checkbox"/>	<input checked="" type="checkbox"/>	<input checked="" type="checkbox"/>
19	None			1	<input checked="" type="checkbox"/>	<input checked="" type="checkbox"/>	<input checked="" type="checkbox"/>	<input checked="" type="checkbox"/>	<input checked="" type="checkbox"/>
20	None			1	<input checked="" type="checkbox"/>	<input checked="" type="checkbox"/>	<input checked="" type="checkbox"/>	<input checked="" type="checkbox"/>	<input checked="" type="checkbox"/>

Services	
XML Application URI:	<input type="text"/>
XML Application Title:	<input type="text"/>
BLF List URI:	<input type="text"/>

Softkeys

2. Select from "**Key 1**" through "**Key 20**".
3. In the "**Type**" field, select "**Auto call distribution**".
4. In the "**Label**" field, enter a label to apply to this ACD key.
5. In the "**Line**" field, select a line to apply Automatic call distribution. Valid values are **1** through **9**.
6. In the state fields, check (enable) or uncheck (disable) the "**idle**" state for this softkey.

Programmable Keys

Note: It is recommended you configure no more than a single ACD programmable key or Expansion Module key per IP phone.

7. Select from "**Key 1**" through "**Key 6**"
8. In the "**Line**" field, select a line to apply Automatic call distribution. Valid values are **1** through **9**.

Expansion Module Keys

9. Select from "**Key 1**" through "**Key 36**" (M670i)
or
Select from "**Key 1**" through "**Key 60**" (M675i)
10. (M675i) In the "**Label**" field, enter a label to apply to this ACD key.
11. In the "**Line**" field, select a line to apply Automatic call distribution. Valid values are **1** through **9**.
12. Click  to save your changes.

Using the ACD Feature on your IP Phone

The ACD feature allows you to login to a phone queue in order to receive distributed calls on your IP phone. To login to a phone queue, you must preconfigure an ACD softkey, programmable key, or expansion module key on your IP Phone as described in the previous procedure.

Your Administrator sets up the queue that you access when you press the ACD Key. Contact your System Administrator for more information.

When you press the ACD Key, the phone prompts you to enter a User ID and Password to login into the queue. Once logged in, you can make your phone "available" or "unavailable" to take calls by pressing the Available/Unavailable Key (▼). The server monitors your IP phone status. When you set the IP phone to "available," the server begins distributing calls to your phone. When you set the IP phone to "unavailable," the server temporarily stops distributing calls to your phone.

The LED for the ACD Key shows the current status of your phone.

ACD LED Table

This LED changes when you log into the phone queue and are available to take calls. The LED changes again when you are busy with an active call. The table below shows the status of the LED as they may appear on your IP phone.

Phone Model	Status: Logged In and Available	Status: Unavailable	Logged Out
6755i	Solid Red LED √ icon	Blinking Red LED Blinking √ icon	No LED ∅ icon

Using the ACD Key

Use the following procedure to log into a phone queue from your IP phone.



IP Phone UI

1. Check with your Administrator to verify the queue linked to your ACD Key.
2. Press the **ACD** Key on your IP phone. The LCD displays the label of the ACD queue you are accessing.

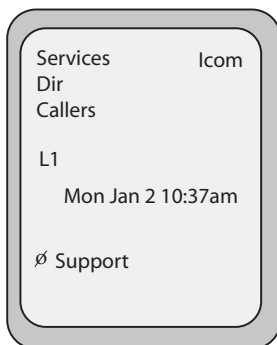

The "User ID" and "Password" prompts displays.

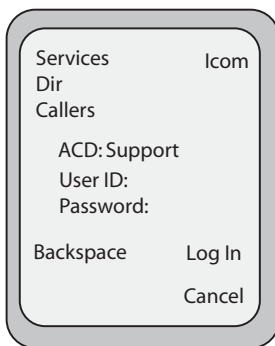

3. Using the keypad, enter your User ID (phone number provided by your System Administrator).

- Using the keypad, enter your Password (provided by your System Administrator) and press the **Log In** Key.



Note: Use the **Backspace** key to move back a space and delete a character if required. Use the **Cancel** softkey to cancel the ACD login.

Your phone logs into the queue on the server.

- You are logged into the queue and the following screen displays.

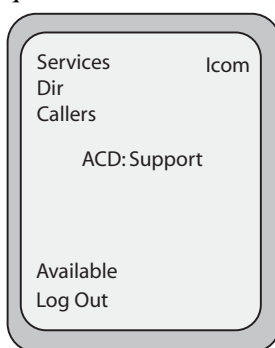

- To allow your phone to be available in the queue, press the **Available** softkey. The following screen displays.

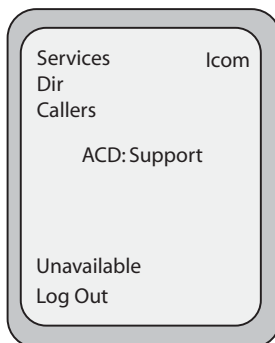

If your IP phone status is set to “**Available**” then the server begins to distribute phone calls from this queue to your IP phone. You must manually change the state to “**Available**” in order to start receiving calls.

- To temporarily stop receiving calls, press the **Unavailable** softkey.

If you are on a call (or miss a call that has been distributed to your phone), your phone status automatically changes to “**Unavailable**”. Your phone remains in the “**Unavailable**” state until one of the following occurs:

- You use the IP Phone UI to manually switch the IP phone state back to “Available”
 - or
 - The availability “timer” for your IP phone expires. This only occurs if your Administrator has configured an auto-availability timer on your IP phone. Contact your System Administrator for more information.
- To logout of the queue, press the **Log Out** softkey. The server no longer distributes phone calls to your IP phone.

Directed Call Pickup/Group Call Pickup Keys (for Sylanro Servers)

Aastra IP phones support the Directed Call Pickup (DCP) and Group Call Pickup (GCP) features.

The DCP/GCP feature allows you to intercept - or pickup - a call on a monitored extension. You can configure this feature using the Aastra Web UI to create a DCP or GCP softkey on the IP phone. When you configure a DCP softkey, you specify the extension that you want to monitor. Then, when the monitored extension receives a call, you press the DCP softkey to pick up the call. If the monitored extension receives multiple incoming calls simultaneously, the IP Phone UI displays a list of incoming calls. You select a call from this list, and are connected to the call.

When you configure a GCP softkey, you specify the ring group (for example, extensions 2200 - 2210) that you want to monitor for incoming calls. When an incoming call is received on any of these extensions, the Operator presses the GCP softkey and is connected to the call. If multiple incoming calls are received simultaneously, the Operator press the GCP softkey, selects an extension from a list, and presses the **Pickup** softkey to answer the call.



Note: Your System Administrator must configure the extension range for the Group Call Pickup feature. Contact your System Administrator for more information.

Configuring Directed Call Pickup (DCP) Key (for Sylantrio Servers)



Aastra Web UI

Use the following procedure to configure Directed Call Pickup on the 6755i IP Phone. The procedure shows the softkey screens as an example.

1. Click on **Operation->Softkeys and XML**.
or
Click on **Operation->Programmable Keys**.
or
Click on **Operation->Expansion Module <N>**.

Key	Type	Label	Value	Line	Idle	Connected	Incoming	Outgoing	Busy
1	WebApps			global	<input checked="" type="checkbox"/>	<input checked="" type="checkbox"/>	<input checked="" type="checkbox"/>	<input checked="" type="checkbox"/>	<input checked="" type="checkbox"/>
2	None			1	<input checked="" type="checkbox"/>	<input checked="" type="checkbox"/>	<input checked="" type="checkbox"/>	<input checked="" type="checkbox"/>	<input checked="" type="checkbox"/>
3	None			1	<input checked="" type="checkbox"/>	<input checked="" type="checkbox"/>	<input checked="" type="checkbox"/>	<input checked="" type="checkbox"/>	<input checked="" type="checkbox"/>
4	None			1	<input checked="" type="checkbox"/>	<input checked="" type="checkbox"/>	<input checked="" type="checkbox"/>	<input checked="" type="checkbox"/>	<input checked="" type="checkbox"/>
5	None			1	<input checked="" type="checkbox"/>	<input checked="" type="checkbox"/>	<input checked="" type="checkbox"/>	<input checked="" type="checkbox"/>	<input checked="" type="checkbox"/>
6	None			1	<input checked="" type="checkbox"/>	<input checked="" type="checkbox"/>	<input checked="" type="checkbox"/>	<input checked="" type="checkbox"/>	<input checked="" type="checkbox"/>
7	None			1	<input checked="" type="checkbox"/>	<input checked="" type="checkbox"/>	<input checked="" type="checkbox"/>	<input checked="" type="checkbox"/>	<input checked="" type="checkbox"/>
8	None			1	<input checked="" type="checkbox"/>	<input checked="" type="checkbox"/>	<input checked="" type="checkbox"/>	<input checked="" type="checkbox"/>	<input checked="" type="checkbox"/>
9	None			1	<input checked="" type="checkbox"/>	<input checked="" type="checkbox"/>	<input checked="" type="checkbox"/>	<input checked="" type="checkbox"/>	<input checked="" type="checkbox"/>
10	None			1	<input checked="" type="checkbox"/>	<input checked="" type="checkbox"/>	<input checked="" type="checkbox"/>	<input checked="" type="checkbox"/>	<input checked="" type="checkbox"/>
11	None			1	<input checked="" type="checkbox"/>	<input checked="" type="checkbox"/>	<input checked="" type="checkbox"/>	<input checked="" type="checkbox"/>	<input checked="" type="checkbox"/>
12	None			1	<input checked="" type="checkbox"/>	<input checked="" type="checkbox"/>	<input checked="" type="checkbox"/>	<input checked="" type="checkbox"/>	<input checked="" type="checkbox"/>
13	None			1	<input checked="" type="checkbox"/>	<input checked="" type="checkbox"/>	<input checked="" type="checkbox"/>	<input checked="" type="checkbox"/>	<input checked="" type="checkbox"/>
14	None			1	<input checked="" type="checkbox"/>	<input checked="" type="checkbox"/>	<input checked="" type="checkbox"/>	<input checked="" type="checkbox"/>	<input checked="" type="checkbox"/>
15	None			1	<input checked="" type="checkbox"/>	<input checked="" type="checkbox"/>	<input checked="" type="checkbox"/>	<input checked="" type="checkbox"/>	<input checked="" type="checkbox"/>
16	None			1	<input checked="" type="checkbox"/>	<input checked="" type="checkbox"/>	<input checked="" type="checkbox"/>	<input checked="" type="checkbox"/>	<input checked="" type="checkbox"/>
17	None			1	<input checked="" type="checkbox"/>	<input checked="" type="checkbox"/>	<input checked="" type="checkbox"/>	<input checked="" type="checkbox"/>	<input checked="" type="checkbox"/>
18	None			1	<input checked="" type="checkbox"/>	<input checked="" type="checkbox"/>	<input checked="" type="checkbox"/>	<input checked="" type="checkbox"/>	<input checked="" type="checkbox"/>
19	None			1	<input checked="" type="checkbox"/>	<input checked="" type="checkbox"/>	<input checked="" type="checkbox"/>	<input checked="" type="checkbox"/>	<input checked="" type="checkbox"/>
20	None			1	<input checked="" type="checkbox"/>	<input checked="" type="checkbox"/>	<input checked="" type="checkbox"/>	<input checked="" type="checkbox"/>	<input checked="" type="checkbox"/>

Services	
XML Application URI:	<input type="text"/>
XML Application Title:	<input type="text"/>
BLF List URI:	<input type="text"/>

Softkeys

2. Select from "**Key 1**" through "**Key 20**".
3. In the "**Type**" field, select **Directed Call Pickup**.
4. In the "**Label**" field, enter a label to apply to this Directed Call Pickup key.
5. In the "**Value**" field, specify the extension you want to intercept when you press this softkey.
For example: **2200**.
6. In the "**Line**" field, select the line for which to apply the Directed Call Pickup configuration.
Valid values are **1** through **9**.
7. In the state fields, check (enable) or uncheck (disable) the states you want to apply to this softkey.

Programmable Keys

8. Select from "**Key 1**" through "**Key 6**"
9. In the "**Value**" field, specify the extension you want to intercept when you press this softkey.
For example: **2200**.
10. In the "**Line**" field, select the line for which to apply the Directed Call Pickup configuration.
Valid values are:
 - global
 - **1** through **9**

Expansion Module Keys

11. Select from "**Key 1**" through "**Key 36**" (M670i)
or
Select from "**Key 1**" through "**Key 60**" (M675i)
12. In the "**Value**" field, specify the extension you want to intercept when you press this softkey.
For example: **2200**.
13. (M675i) In the "**Label**" field, enter a label to apply to this Directed Call Pickup key.
14. In the "**Line**" field, select the line for which to apply the Directed Call Pickup configuration.
Valid values are:
 - global
 - **1** through **9**.
15. Click  to save your changes.

Configuring Group Call Pickup (GCP) Key (for Sylanro Servers)



Aastra Web UI

Use the following procedure to configure Group Call Pickup on the 6755i IP Phone. The procedure shows the softkey screens as an example.



Note: A ring group must be configured on the Sylanro Server in order for a GCP softkey to function.

1. Click on **Operation->Softkeys and XML**.
or
Click on **Operation->Programmable Keys**.
or
Click on **Operation->Expansion Module <N>**.

Key	Type	Label	Value	Line	Idle	Connected	Incoming	Outgoing	Busy
1	WebApps			global	<input checked="" type="checkbox"/>	<input checked="" type="checkbox"/>	<input checked="" type="checkbox"/>	<input checked="" type="checkbox"/>	<input checked="" type="checkbox"/>
2	None			1	<input checked="" type="checkbox"/>	<input checked="" type="checkbox"/>	<input checked="" type="checkbox"/>	<input checked="" type="checkbox"/>	<input checked="" type="checkbox"/>
3	None			1	<input checked="" type="checkbox"/>	<input checked="" type="checkbox"/>	<input checked="" type="checkbox"/>	<input checked="" type="checkbox"/>	<input checked="" type="checkbox"/>
4	None			1	<input checked="" type="checkbox"/>	<input checked="" type="checkbox"/>	<input checked="" type="checkbox"/>	<input checked="" type="checkbox"/>	<input checked="" type="checkbox"/>
5	None			1	<input checked="" type="checkbox"/>	<input checked="" type="checkbox"/>	<input checked="" type="checkbox"/>	<input checked="" type="checkbox"/>	<input checked="" type="checkbox"/>
6	None			1	<input checked="" type="checkbox"/>	<input checked="" type="checkbox"/>	<input checked="" type="checkbox"/>	<input checked="" type="checkbox"/>	<input checked="" type="checkbox"/>
7	None			1	<input checked="" type="checkbox"/>	<input checked="" type="checkbox"/>	<input checked="" type="checkbox"/>	<input checked="" type="checkbox"/>	<input checked="" type="checkbox"/>
8	None			1	<input checked="" type="checkbox"/>	<input checked="" type="checkbox"/>	<input checked="" type="checkbox"/>	<input checked="" type="checkbox"/>	<input checked="" type="checkbox"/>
9	None			1	<input checked="" type="checkbox"/>	<input checked="" type="checkbox"/>	<input checked="" type="checkbox"/>	<input checked="" type="checkbox"/>	<input checked="" type="checkbox"/>
10	None			1	<input checked="" type="checkbox"/>	<input checked="" type="checkbox"/>	<input checked="" type="checkbox"/>	<input checked="" type="checkbox"/>	<input checked="" type="checkbox"/>
11	None			1	<input checked="" type="checkbox"/>	<input checked="" type="checkbox"/>	<input checked="" type="checkbox"/>	<input checked="" type="checkbox"/>	<input checked="" type="checkbox"/>
12	None			1	<input checked="" type="checkbox"/>	<input checked="" type="checkbox"/>	<input checked="" type="checkbox"/>	<input checked="" type="checkbox"/>	<input checked="" type="checkbox"/>
13	None			1	<input checked="" type="checkbox"/>	<input checked="" type="checkbox"/>	<input checked="" type="checkbox"/>	<input checked="" type="checkbox"/>	<input checked="" type="checkbox"/>
14	None			1	<input checked="" type="checkbox"/>	<input checked="" type="checkbox"/>	<input checked="" type="checkbox"/>	<input checked="" type="checkbox"/>	<input checked="" type="checkbox"/>
15	None			1	<input checked="" type="checkbox"/>	<input checked="" type="checkbox"/>	<input checked="" type="checkbox"/>	<input checked="" type="checkbox"/>	<input checked="" type="checkbox"/>
16	None			1	<input checked="" type="checkbox"/>	<input checked="" type="checkbox"/>	<input checked="" type="checkbox"/>	<input checked="" type="checkbox"/>	<input checked="" type="checkbox"/>
17	None			1	<input checked="" type="checkbox"/>	<input checked="" type="checkbox"/>	<input checked="" type="checkbox"/>	<input checked="" type="checkbox"/>	<input checked="" type="checkbox"/>
18	None			1	<input checked="" type="checkbox"/>	<input checked="" type="checkbox"/>	<input checked="" type="checkbox"/>	<input checked="" type="checkbox"/>	<input checked="" type="checkbox"/>
19	None			1	<input checked="" type="checkbox"/>	<input checked="" type="checkbox"/>	<input checked="" type="checkbox"/>	<input checked="" type="checkbox"/>	<input checked="" type="checkbox"/>
20	None			1	<input checked="" type="checkbox"/>	<input checked="" type="checkbox"/>	<input checked="" type="checkbox"/>	<input checked="" type="checkbox"/>	<input checked="" type="checkbox"/>

Services	
XML Application URI:	<input type="text"/>
XML Application Title:	<input type="text"/>
BLF List URI:	<input type="text"/>

Softkeys

2. Select from "Key 1" through "Key 20".
3. In the "Type" field, select **Directed Call Pickup**.
4. In the "Label" field, enter a label to apply to this Group Call Pickup key.
5. In the "Value" field, enter **groupcallpickup**.
6. In the "Line" field, select the line for which to apply the Group Call Pickup configuration. Valid value are 1 through 9.
7. In the state fields, check (enable) or uncheck (disable) the states you want to apply to this softkey.

Programmable Keys

8. Select from "**Key 1**" through "**Key 6**"
9. In the "**Value**" field, specify the extension you want to intercept when you press this softkey.
For example: **groupcallpickup**.
10. In the "**Line**" field, select the line for which to apply the Directed Call Pickup configuration.
Valid values are:
 - global
 - **1** through **9**

Expansion Module Keys

11. Select from "**Key 1**" through "**Key 36**" (M670i)
or
Select from "**Key 1**" through "**Key 60**" (M675i)
12. In the "**Value**" field, specify the extension you want to intercept when you press this softkey.
For example: **groupcallpickup**.
13. (M675i) In the "**Label**" field, enter a label to apply to this Group Call Pickup key.
14. In the "**Line**" field, select the line for which to apply the Directed Call Pickup configuration.
Valid values are:
 - global
 - **1** through **9**.
15. Click  to save your changes.

Using Directed Call Pickup/Group Call Pickup

Use the following procedure for the DCP/GCP feature on your phone.

**IP Phone UI**

Note: Before using the DCP/GCP feature on your phone, you must first configure the DCP or GCP Key. You must identify the extension(s) or phone number(s) you want to monitor when configuring the key. See the previous procedures to configure a DCP or GCP Key.

Using Directed Call Pickup (DCP)

1. When the monitored extension receives a call, press the **DCP** Key to pick up the call.
If the monitored extension receives multiple incoming calls simultaneously, the phone displays a list of incoming calls.
2. Use the 5 and 2 keys to scroll through the list to select an extension.
3. Press the **Pickup** Key for the extension you select.
The call is answered.

Using Group Call Pickup (GCP)

1. If any of the monitored group of extensions receives a call, press the **GCP** Key.
The call is answered.
If the monitored group of extensions receives multiple incoming calls simultaneously, the phone displays a list of incoming calls.
2. Use the 5 and 2 keys to scroll through the list to select an extension.
3. Press the **Pickup** Key for the extension you select.
The call is answered.

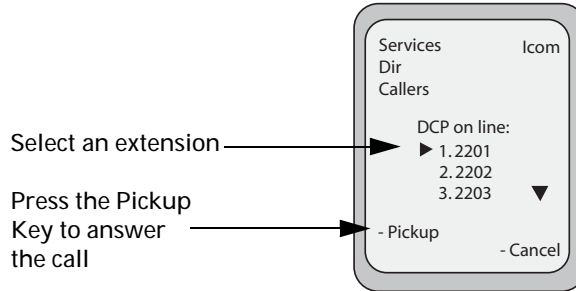

XML Key

The 6755i IP phone has a feature you can enable called "**XML**" (Extensible Markup Language). XML is a markup language much like HTML. Your System Administrator can create customized XML menu services and load them to your IP phone. These services include things like weather and traffic reports, contact information, company info, stock quotes, or custom call scripts. You can configure XML using the Aastra Web UI only.



Note: The XML services must be set up by your System Administrator before you can use the key. Contact your System Administrator for more information.

On the 6755i IP phone, you can access the XML applications from the IP Phone UI in two ways:

- Via the "**Services**" menu
- Via an XML key

By default, the Services key is the first key on the top, left keys.

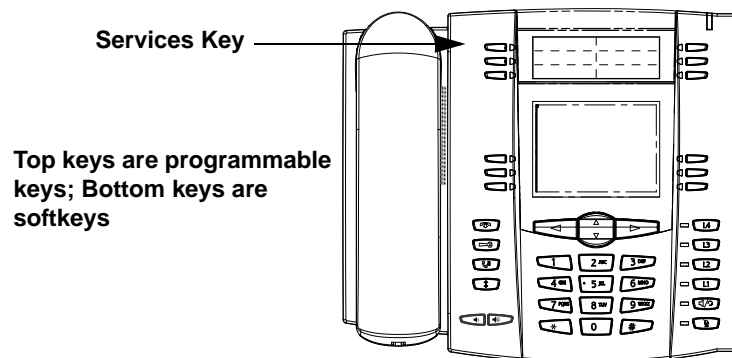

Using the Aastra Web UI, you can configure a key to access XML applications. Under *Operations->Softkeys and XML*, *Operations->Programmable Keys*, or *Operations->Expansion Module*, you can assign a key the type "XML".

You must also specify an XML URI and a Services label using the following XML fields:

- XML Application URI
- XML Application Title

The XML Application URI is the URI loaded by your phone. The phone performs an HTTP GET. Contact your System Administrator for the applicable XML URI to enter in the "XML Application URI" field.

The XML Application Title is the label that displays beside the XML softkey on your phone. If you use the Services key to access the XML features, the "XML Application Title" is the label that displays on the Services Menu in the IP Phone UI.



Note: Contact your System Administrator for the applicable URI to enter in this field.

After the XML application is applied, you can use the IP Phone UI to press the Services key and access the XML services.

Configuring XML Services



Aastra Web UI

1. Click on **Operation->Softkeys and XML**.
or
Click on **Operation->Programmable Keys**.
or
Click on **Operation->Expansion Module <N>**.

Status		Softkeys Configuration									
System Information		Key	Type	Label	Value	Line	Idle	Connected	Incoming	Outgoing	Busy
Operation		1	WebApps			global	<input checked="" type="checkbox"/>	<input checked="" type="checkbox"/>	<input checked="" type="checkbox"/>	<input checked="" type="checkbox"/>	<input checked="" type="checkbox"/>
User Password		2	None			1	<input checked="" type="checkbox"/>	<input checked="" type="checkbox"/>	<input checked="" type="checkbox"/>	<input checked="" type="checkbox"/>	<input checked="" type="checkbox"/>
Phone Lock		3	None			1	<input checked="" type="checkbox"/>	<input checked="" type="checkbox"/>	<input checked="" type="checkbox"/>	<input checked="" type="checkbox"/>	<input checked="" type="checkbox"/>
Softkeys and XML		4	None			1	<input checked="" type="checkbox"/>	<input checked="" type="checkbox"/>	<input checked="" type="checkbox"/>	<input checked="" type="checkbox"/>	<input checked="" type="checkbox"/>
Programmable Keys		5	None			1	<input checked="" type="checkbox"/>	<input checked="" type="checkbox"/>	<input checked="" type="checkbox"/>	<input checked="" type="checkbox"/>	<input checked="" type="checkbox"/>
Keypad Speed Dial		6	None			1	<input checked="" type="checkbox"/>	<input checked="" type="checkbox"/>	<input checked="" type="checkbox"/>	<input checked="" type="checkbox"/>	<input checked="" type="checkbox"/>
Directory		7	None			1	<input checked="" type="checkbox"/>	<input checked="" type="checkbox"/>	<input checked="" type="checkbox"/>	<input checked="" type="checkbox"/>	<input checked="" type="checkbox"/>
Reset		8	None			1	<input checked="" type="checkbox"/>	<input checked="" type="checkbox"/>	<input checked="" type="checkbox"/>	<input checked="" type="checkbox"/>	<input checked="" type="checkbox"/>
Basic Settings		9	None			1	<input checked="" type="checkbox"/>	<input checked="" type="checkbox"/>	<input checked="" type="checkbox"/>	<input checked="" type="checkbox"/>	<input checked="" type="checkbox"/>
Preferences		10	None			1	<input checked="" type="checkbox"/>	<input checked="" type="checkbox"/>	<input checked="" type="checkbox"/>	<input checked="" type="checkbox"/>	<input checked="" type="checkbox"/>
Account Configuration		11	None			1	<input checked="" type="checkbox"/>	<input checked="" type="checkbox"/>	<input checked="" type="checkbox"/>	<input checked="" type="checkbox"/>	<input checked="" type="checkbox"/>
		12	None			1	<input checked="" type="checkbox"/>	<input checked="" type="checkbox"/>	<input checked="" type="checkbox"/>	<input checked="" type="checkbox"/>	<input checked="" type="checkbox"/>
		13	None			1	<input checked="" type="checkbox"/>	<input checked="" type="checkbox"/>	<input checked="" type="checkbox"/>	<input checked="" type="checkbox"/>	<input checked="" type="checkbox"/>
		14	None			1	<input checked="" type="checkbox"/>	<input checked="" type="checkbox"/>	<input checked="" type="checkbox"/>	<input checked="" type="checkbox"/>	<input checked="" type="checkbox"/>
		15	None			1	<input checked="" type="checkbox"/>	<input checked="" type="checkbox"/>	<input checked="" type="checkbox"/>	<input checked="" type="checkbox"/>	<input checked="" type="checkbox"/>
		16	None			1	<input checked="" type="checkbox"/>	<input checked="" type="checkbox"/>	<input checked="" type="checkbox"/>	<input checked="" type="checkbox"/>	<input checked="" type="checkbox"/>
		17	None			1	<input checked="" type="checkbox"/>	<input checked="" type="checkbox"/>	<input checked="" type="checkbox"/>	<input checked="" type="checkbox"/>	<input checked="" type="checkbox"/>
		18	None			1	<input checked="" type="checkbox"/>	<input checked="" type="checkbox"/>	<input checked="" type="checkbox"/>	<input checked="" type="checkbox"/>	<input checked="" type="checkbox"/>
		19	None			1	<input checked="" type="checkbox"/>	<input checked="" type="checkbox"/>	<input checked="" type="checkbox"/>	<input checked="" type="checkbox"/>	<input checked="" type="checkbox"/>
		20	None			1	<input checked="" type="checkbox"/>	<input checked="" type="checkbox"/>	<input checked="" type="checkbox"/>	<input checked="" type="checkbox"/>	<input checked="" type="checkbox"/>
		Services									
		XML Application URI:					<input type="text"/>				
		XML Application Title:					<input type="text"/>				
		BLF List URI:					<input type="text"/>				

Softkeys

2. Select from "**Key 1**" through "**Key 20**".
3. In the "**Type**" field, select "**Services**".
4. In the "**Label**" field, enter a label for the Services key.
5. In the state fields, check (enable) or uncheck (disable) the states you want to apply to this softkey.
6. In the "**XML Application URI**" field, enter an application URI(s).



Note: Contact your System Administrator for the appropriate value(s) to enter in the "XML Application URI" field.

7. In the "**XML Application Title**" field, enter the title of the service. This title appears in the Services Menu after pressing the **Services** key. If multiple XML applications are specified in the **XML Application URI** field, a list of applications displays after pressing the **Services** key.

Programmable Keys

8. Select from "**Key 1**" through "**Key 6**".
9. In the "**Type**" field, select "**Services**".
10. In the "**XML Application URI**" field, enter an application URI(s).



Note: Contact your System Administrator for the appropriate value(s) to enter in the "XML Application URI" field.

11. In the "**XML Application Title**" field, enter the title of the service. This title appears in the Services Menu after pressing the **Services** key. If multiple XML applications are specified in the **XML Application URI** field, a list of applications displays after pressing the **Services** key.

Expansion Module Keys

12. Select from "**Key 1**" through "**Key 36**" (M670i)
or
Select from "**Key 1**" through "**Key 60**" (M675i)
13. In the "**Type**" field, select "**Services**".
14. (M675i) In the "**Label**" field, enter a label for the Services key.
15. In the "**XML Application URI**" field, enter an application URI(s).



Note: Contact your System Administrator for the appropriate value(s) to enter in the "XML Application URI" field.

16. In the "XML Application Title" field, enter the title of the service. This title appears in the Services Menu after pressing the **Services** key. If multiple XML applications are specified in the XML Application URI field, a list of applications displays after pressing the **Services** key.
17. Click  to save your changes.

Configuring an XML Key

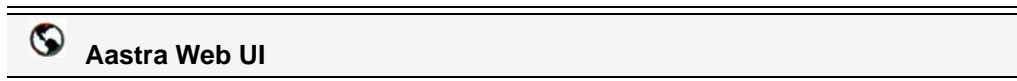

Use the following procedure to configure an XML key on the 6755i IP Phone. The procedure shows the softkey screen as an example.

1. Click on **Operation->Softkeys and XML**.
or
Click on **Operation->Programmable Keys**.
or
Click on **Operation->Expansion Module <N>**.

<p>Status</p> <ul style="list-style-type: none"> System Information Operation User Password Phone Lock Softkeys and XML Programmable Keys Keypad Speed Dial Directory Reset Basic Settings Preferences Account Configuration 	<p style="text-align: center;">Softkeys Configuration</p> <table border="1"> <thead> <tr> <th>Key</th> <th>Type</th> <th>Label</th> <th>Value</th> <th>Line</th> <th>Idle</th> <th>Connected</th> <th>Incoming</th> <th>Outgoing</th> <th>Busy</th> </tr> </thead> <tbody> <tr> <td>1</td> <td>WebApps</td> <td></td> <td></td> <td>global</td> <td><input checked="" type="checkbox"/></td> <td><input checked="" type="checkbox"/></td> <td><input checked="" type="checkbox"/></td> <td><input checked="" type="checkbox"/></td> <td><input checked="" type="checkbox"/></td> </tr> <tr> <td>2</td> <td>None</td> <td></td> <td></td> <td>1</td> <td><input checked="" type="checkbox"/></td> <td><input checked="" type="checkbox"/></td> <td><input checked="" type="checkbox"/></td> <td><input checked="" type="checkbox"/></td> <td><input checked="" type="checkbox"/></td> </tr> <tr> <td>3</td> <td>None</td> <td></td> <td></td> <td>1</td> <td><input checked="" type="checkbox"/></td> <td><input checked="" type="checkbox"/></td> <td><input checked="" type="checkbox"/></td> <td><input checked="" type="checkbox"/></td> <td><input checked="" type="checkbox"/></td> </tr> <tr> <td>4</td> <td>None</td> <td></td> <td></td> <td>1</td> <td><input checked="" type="checkbox"/></td> <td><input checked="" type="checkbox"/></td> <td><input checked="" type="checkbox"/></td> <td><input checked="" type="checkbox"/></td> <td><input checked="" type="checkbox"/></td> </tr> <tr> <td>5</td> <td>None</td> <td></td> <td></td> <td>1</td> <td><input checked="" type="checkbox"/></td> <td><input checked="" type="checkbox"/></td> <td><input checked="" type="checkbox"/></td> <td><input checked="" type="checkbox"/></td> <td><input checked="" type="checkbox"/></td> </tr> <tr> <td>6</td> <td>None</td> <td></td> <td></td> <td>1</td> <td><input checked="" type="checkbox"/></td> <td><input checked="" type="checkbox"/></td> <td><input checked="" type="checkbox"/></td> <td><input checked="" type="checkbox"/></td> <td><input checked="" type="checkbox"/></td> </tr> <tr> <td>7</td> <td>None</td> <td></td> <td></td> <td>1</td> <td><input checked="" type="checkbox"/></td> <td><input checked="" type="checkbox"/></td> <td><input checked="" type="checkbox"/></td> <td><input checked="" type="checkbox"/></td> <td><input checked="" type="checkbox"/></td> </tr> <tr> <td>8</td> <td>None</td> <td></td> <td></td> <td>1</td> <td><input checked="" type="checkbox"/></td> <td><input checked="" type="checkbox"/></td> <td><input checked="" type="checkbox"/></td> <td><input checked="" type="checkbox"/></td> <td><input checked="" type="checkbox"/></td> </tr> <tr> <td>9</td> <td>None</td> <td></td> <td></td> <td>1</td> <td><input checked="" type="checkbox"/></td> <td><input checked="" type="checkbox"/></td> <td><input checked="" type="checkbox"/></td> <td><input checked="" type="checkbox"/></td> <td><input checked="" type="checkbox"/></td> </tr> <tr> <td>10</td> <td>None</td> <td></td> <td></td> <td>1</td> <td><input checked="" type="checkbox"/></td> <td><input checked="" type="checkbox"/></td> <td><input checked="" type="checkbox"/></td> <td><input checked="" type="checkbox"/></td> <td><input checked="" type="checkbox"/></td> </tr> <tr> <td>11</td> <td>None</td> <td></td> <td></td> <td>1</td> <td><input checked="" type="checkbox"/></td> <td><input checked="" type="checkbox"/></td> <td><input checked="" type="checkbox"/></td> <td><input checked="" type="checkbox"/></td> <td><input checked="" type="checkbox"/></td> </tr> <tr> <td>12</td> <td>None</td> <td></td> <td></td> <td>1</td> <td><input checked="" type="checkbox"/></td> <td><input checked="" type="checkbox"/></td> <td><input checked="" type="checkbox"/></td> <td><input checked="" type="checkbox"/></td> <td><input checked="" type="checkbox"/></td> </tr> <tr> <td>13</td> <td>None</td> <td></td> <td></td> <td>1</td> <td><input checked="" type="checkbox"/></td> <td><input checked="" type="checkbox"/></td> <td><input checked="" type="checkbox"/></td> <td><input checked="" type="checkbox"/></td> <td><input checked="" type="checkbox"/></td> </tr> <tr> <td>14</td> <td>None</td> <td></td> <td></td> <td>1</td> <td><input checked="" type="checkbox"/></td> <td><input checked="" type="checkbox"/></td> <td><input checked="" type="checkbox"/></td> <td><input checked="" type="checkbox"/></td> <td><input checked="" type="checkbox"/></td> </tr> <tr> <td>15</td> <td>None</td> <td></td> <td></td> <td>1</td> <td><input checked="" type="checkbox"/></td> <td><input checked="" type="checkbox"/></td> <td><input checked="" type="checkbox"/></td> <td><input checked="" type="checkbox"/></td> <td><input checked="" type="checkbox"/></td> </tr> <tr> <td>16</td> <td>None</td> <td></td> <td></td> <td>1</td> <td><input checked="" type="checkbox"/></td> <td><input checked="" type="checkbox"/></td> <td><input checked="" type="checkbox"/></td> <td><input checked="" type="checkbox"/></td> <td><input checked="" type="checkbox"/></td> </tr> <tr> <td>17</td> <td>None</td> <td></td> <td></td> <td>1</td> <td><input checked="" type="checkbox"/></td> <td><input checked="" type="checkbox"/></td> <td><input checked="" type="checkbox"/></td> <td><input checked="" type="checkbox"/></td> <td><input checked="" type="checkbox"/></td> </tr> <tr> <td>18</td> <td>None</td> <td></td> <td></td> <td>1</td> <td><input checked="" type="checkbox"/></td> <td><input checked="" type="checkbox"/></td> <td><input checked="" type="checkbox"/></td> <td><input checked="" type="checkbox"/></td> <td><input checked="" type="checkbox"/></td> </tr> <tr> <td>19</td> <td>None</td> <td></td> <td></td> <td>1</td> <td><input checked="" type="checkbox"/></td> <td><input checked="" type="checkbox"/></td> <td><input checked="" type="checkbox"/></td> <td><input checked="" type="checkbox"/></td> <td><input checked="" type="checkbox"/></td> </tr> <tr> <td>20</td> <td>None</td> <td></td> <td></td> <td>1</td> <td><input checked="" type="checkbox"/></td> <td><input checked="" type="checkbox"/></td> <td><input checked="" type="checkbox"/></td> <td><input checked="" type="checkbox"/></td> <td><input checked="" type="checkbox"/></td> </tr> </tbody> </table> <p>Services</p> <p>XML Application URI: <input type="text"/></p> <p>XML Application Title: <input type="text"/></p> <p>BLF List URI: <input type="text"/></p>	Key	Type	Label	Value	Line	Idle	Connected	Incoming	Outgoing	Busy	1	WebApps			global	<input checked="" type="checkbox"/>	<input checked="" type="checkbox"/>	<input checked="" type="checkbox"/>	<input checked="" type="checkbox"/>	<input checked="" type="checkbox"/>	2	None			1	<input checked="" type="checkbox"/>	<input checked="" type="checkbox"/>	<input checked="" type="checkbox"/>	<input checked="" type="checkbox"/>	<input checked="" type="checkbox"/>	3	None			1	<input checked="" type="checkbox"/>	<input checked="" type="checkbox"/>	<input checked="" type="checkbox"/>	<input checked="" type="checkbox"/>	<input checked="" type="checkbox"/>	4	None			1	<input checked="" type="checkbox"/>	<input checked="" type="checkbox"/>	<input checked="" type="checkbox"/>	<input checked="" type="checkbox"/>	<input checked="" type="checkbox"/>	5	None			1	<input checked="" type="checkbox"/>	<input checked="" type="checkbox"/>	<input checked="" type="checkbox"/>	<input checked="" type="checkbox"/>	<input checked="" type="checkbox"/>	6	None			1	<input checked="" type="checkbox"/>	<input checked="" type="checkbox"/>	<input checked="" type="checkbox"/>	<input checked="" type="checkbox"/>	<input checked="" type="checkbox"/>	7	None			1	<input checked="" type="checkbox"/>	<input checked="" type="checkbox"/>	<input checked="" type="checkbox"/>	<input checked="" type="checkbox"/>	<input checked="" type="checkbox"/>	8	None			1	<input checked="" type="checkbox"/>	<input checked="" type="checkbox"/>	<input checked="" type="checkbox"/>	<input checked="" type="checkbox"/>	<input checked="" type="checkbox"/>	9	None			1	<input checked="" type="checkbox"/>	<input checked="" type="checkbox"/>	<input checked="" type="checkbox"/>	<input checked="" type="checkbox"/>	<input checked="" type="checkbox"/>	10	None			1	<input checked="" type="checkbox"/>	<input checked="" type="checkbox"/>	<input checked="" type="checkbox"/>	<input checked="" type="checkbox"/>	<input checked="" type="checkbox"/>	11	None			1	<input checked="" type="checkbox"/>	<input checked="" type="checkbox"/>	<input checked="" type="checkbox"/>	<input checked="" type="checkbox"/>	<input checked="" type="checkbox"/>	12	None			1	<input checked="" type="checkbox"/>	<input checked="" type="checkbox"/>	<input checked="" type="checkbox"/>	<input checked="" type="checkbox"/>	<input checked="" type="checkbox"/>	13	None			1	<input checked="" type="checkbox"/>	<input checked="" type="checkbox"/>	<input checked="" type="checkbox"/>	<input checked="" type="checkbox"/>	<input checked="" type="checkbox"/>	14	None			1	<input checked="" type="checkbox"/>	<input checked="" type="checkbox"/>	<input checked="" type="checkbox"/>	<input checked="" type="checkbox"/>	<input checked="" type="checkbox"/>	15	None			1	<input checked="" type="checkbox"/>	<input checked="" type="checkbox"/>	<input checked="" type="checkbox"/>	<input checked="" type="checkbox"/>	<input checked="" type="checkbox"/>	16	None			1	<input checked="" type="checkbox"/>	<input checked="" type="checkbox"/>	<input checked="" type="checkbox"/>	<input checked="" type="checkbox"/>	<input checked="" type="checkbox"/>	17	None			1	<input checked="" type="checkbox"/>	<input checked="" type="checkbox"/>	<input checked="" type="checkbox"/>	<input checked="" type="checkbox"/>	<input checked="" type="checkbox"/>	18	None			1	<input checked="" type="checkbox"/>	<input checked="" type="checkbox"/>	<input checked="" type="checkbox"/>	<input checked="" type="checkbox"/>	<input checked="" type="checkbox"/>	19	None			1	<input checked="" type="checkbox"/>	<input checked="" type="checkbox"/>	<input checked="" type="checkbox"/>	<input checked="" type="checkbox"/>	<input checked="" type="checkbox"/>	20	None			1	<input checked="" type="checkbox"/>	<input checked="" type="checkbox"/>	<input checked="" type="checkbox"/>	<input checked="" type="checkbox"/>	<input checked="" type="checkbox"/>
Key	Type	Label	Value	Line	Idle	Connected	Incoming	Outgoing	Busy																																																																																																																																																																																																										
1	WebApps			global	<input checked="" type="checkbox"/>	<input checked="" type="checkbox"/>	<input checked="" type="checkbox"/>	<input checked="" type="checkbox"/>	<input checked="" type="checkbox"/>																																																																																																																																																																																																										
2	None			1	<input checked="" type="checkbox"/>	<input checked="" type="checkbox"/>	<input checked="" type="checkbox"/>	<input checked="" type="checkbox"/>	<input checked="" type="checkbox"/>																																																																																																																																																																																																										
3	None			1	<input checked="" type="checkbox"/>	<input checked="" type="checkbox"/>	<input checked="" type="checkbox"/>	<input checked="" type="checkbox"/>	<input checked="" type="checkbox"/>																																																																																																																																																																																																										
4	None			1	<input checked="" type="checkbox"/>	<input checked="" type="checkbox"/>	<input checked="" type="checkbox"/>	<input checked="" type="checkbox"/>	<input checked="" type="checkbox"/>																																																																																																																																																																																																										
5	None			1	<input checked="" type="checkbox"/>	<input checked="" type="checkbox"/>	<input checked="" type="checkbox"/>	<input checked="" type="checkbox"/>	<input checked="" type="checkbox"/>																																																																																																																																																																																																										
6	None			1	<input checked="" type="checkbox"/>	<input checked="" type="checkbox"/>	<input checked="" type="checkbox"/>	<input checked="" type="checkbox"/>	<input checked="" type="checkbox"/>																																																																																																																																																																																																										
7	None			1	<input checked="" type="checkbox"/>	<input checked="" type="checkbox"/>	<input checked="" type="checkbox"/>	<input checked="" type="checkbox"/>	<input checked="" type="checkbox"/>																																																																																																																																																																																																										
8	None			1	<input checked="" type="checkbox"/>	<input checked="" type="checkbox"/>	<input checked="" type="checkbox"/>	<input checked="" type="checkbox"/>	<input checked="" type="checkbox"/>																																																																																																																																																																																																										
9	None			1	<input checked="" type="checkbox"/>	<input checked="" type="checkbox"/>	<input checked="" type="checkbox"/>	<input checked="" type="checkbox"/>	<input checked="" type="checkbox"/>																																																																																																																																																																																																										
10	None			1	<input checked="" type="checkbox"/>	<input checked="" type="checkbox"/>	<input checked="" type="checkbox"/>	<input checked="" type="checkbox"/>	<input checked="" type="checkbox"/>																																																																																																																																																																																																										
11	None			1	<input checked="" type="checkbox"/>	<input checked="" type="checkbox"/>	<input checked="" type="checkbox"/>	<input checked="" type="checkbox"/>	<input checked="" type="checkbox"/>																																																																																																																																																																																																										
12	None			1	<input checked="" type="checkbox"/>	<input checked="" type="checkbox"/>	<input checked="" type="checkbox"/>	<input checked="" type="checkbox"/>	<input checked="" type="checkbox"/>																																																																																																																																																																																																										
13	None			1	<input checked="" type="checkbox"/>	<input checked="" type="checkbox"/>	<input checked="" type="checkbox"/>	<input checked="" type="checkbox"/>	<input checked="" type="checkbox"/>																																																																																																																																																																																																										
14	None			1	<input checked="" type="checkbox"/>	<input checked="" type="checkbox"/>	<input checked="" type="checkbox"/>	<input checked="" type="checkbox"/>	<input checked="" type="checkbox"/>																																																																																																																																																																																																										
15	None			1	<input checked="" type="checkbox"/>	<input checked="" type="checkbox"/>	<input checked="" type="checkbox"/>	<input checked="" type="checkbox"/>	<input checked="" type="checkbox"/>																																																																																																																																																																																																										
16	None			1	<input checked="" type="checkbox"/>	<input checked="" type="checkbox"/>	<input checked="" type="checkbox"/>	<input checked="" type="checkbox"/>	<input checked="" type="checkbox"/>																																																																																																																																																																																																										
17	None			1	<input checked="" type="checkbox"/>	<input checked="" type="checkbox"/>	<input checked="" type="checkbox"/>	<input checked="" type="checkbox"/>	<input checked="" type="checkbox"/>																																																																																																																																																																																																										
18	None			1	<input checked="" type="checkbox"/>	<input checked="" type="checkbox"/>	<input checked="" type="checkbox"/>	<input checked="" type="checkbox"/>	<input checked="" type="checkbox"/>																																																																																																																																																																																																										
19	None			1	<input checked="" type="checkbox"/>	<input checked="" type="checkbox"/>	<input checked="" type="checkbox"/>	<input checked="" type="checkbox"/>	<input checked="" type="checkbox"/>																																																																																																																																																																																																										
20	None			1	<input checked="" type="checkbox"/>	<input checked="" type="checkbox"/>	<input checked="" type="checkbox"/>	<input checked="" type="checkbox"/>	<input checked="" type="checkbox"/>																																																																																																																																																																																																										

Softkeys

2. Select from "Key 1" through "Key 20".
3. In the "Type" field, select "XML".
4. In the "Label" field, enter a label to apply to this key.

5. In the "**Value**" field, enter a URI(s) to apply to this key.



Note: Contact your System Administrator for the appropriate value(s) to enter in the "Value" field.

6. In the state fields, check (enable) or uncheck (disable) the states you want to apply to this softkey.
7. In the "**XML Application URI**" field, enter the applicable URI(s).



Note: Contact your System Administrator for the appropriate value(s) to enter in the "XML Application URI" field.

8. In the "**XML Application Title**" field, enter the title of the service. This title appears on the phone's LCD after pressing the **XML** key. If multiple XML applications are specified in the **XML Application URI** field, a list of applications displays after pressing the XML key.

Programmable Keys

9. Select from "**Key 1**" through "**Key 6**"
10. In the "**Type**" field, select "**XML**".
11. In the "**Value**" field, enter a URI(s) to apply to this key.



Note: Contact your System Administrator for the appropriate value(s) to enter in the "Value" field.

12. In the "**XML Application URI**" field, enter the applicable URI(s).



Note: Contact your System Administrator for the appropriate value(s) to enter in the "XML Application URI" field.

13. In the "**XML Application Title**" field, enter the title of the service. This title appears on the phone's LCD after pressing the **XML** key. If multiple XML applications are specified in the **XML Application URI** field, a list of applications displays after pressing the XML key.

Expansion Module Keys

14. Select from "**Key 1**" through "**Key 36**" (M670i)
or
Select from "**Key 1**" through "**Key 60**" (M675i)
15. In the "**Type**" field, select "**XML**".
16. In the "**Value**" field, enter a URI(s) to apply to this key.



Note: Contact your System Administrator for the appropriate value(s) to enter in the "Value" field.

17. (M675i) In the "**Label**" field, enter a label to apply to this key.

18. In the "XML Application URI" field, enter the applicable URI(s).



Note: Contact your System Administrator for the appropriate value(s) to enter in the "XML Application URI" field.

19. In the "XML Application Title" field, enter the title of the service. This title appears on the phone's LCD after pressing the XML key. If multiple XML applications are specified in the XML Application URI field, a list of applications displays after pressing the XML key.

20. Click  to save your changes.

Accessing the XML Service

After an XML application(s) has been saved to your IP phone, and either the Services Menu or a key have been configured to access the XML applications, the customized service is ready for you to use.



IP Phone UI

From the Services Menu

Use the following procedure to access XML applications from the Services Menu. Use the following illustration as a reference.

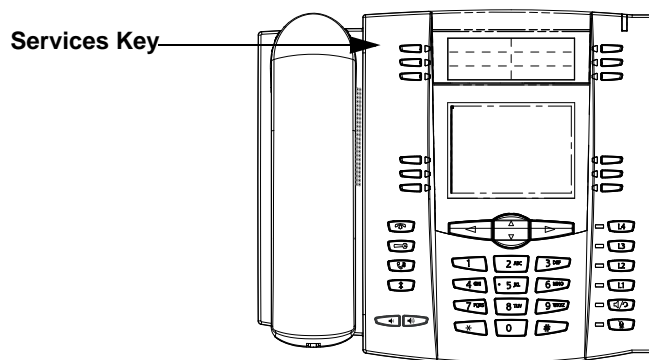

1. Press the **Services** key.
2. Use the 5 and 2 to scroll through the items.
3. For menu and directory services, select a service to display the information for that customized service. Message services display to the screen after pressing the softkey or programmable key. For user input services, follow the prompts as appropriate.
4. To exit from the "Services" menu, press the Services key again.

From an XML Key

1. Press the XML key on the 6755i phone. A "**Custom Features**" screen displays or the title you specified.
2. Use the 5 and 2 to scroll through the customized features.
3. For menu and directory services, select a service to display the information for that customized service. Message services display to the screen after pressing the programmable key. For user input services, follow the prompts as appropriate.
4. To exit from the "**Customized Features**" screen, press the XML key again.

Flash Key

You can set a key to generate a flash event when it is pressed on the 6755i. You do this by setting the key to "flash". The IP phone generates flash events only when a call is connected and there is an active RTP stream (for example, when the call is not on hold).

Configuring a Flash Key



Aastra Web UI

Use the following procedure to configure a Flash key on the 6755i IP Phone. The procedure shows the softkey screen as an example.

1. Click on **Operation->Softkeys and XML**.
or
Click on **Operation->Programmable Keys**.
or
Click on **Operation->Expansion Module <N>**.

Status System Information Operation User Password Phone Lock Softkeys and XML Programmable Keys Keypad Speed Dial Directory Reset Basic Settings Preferences Account Configuration	Softkeys Configuration									
	Key	Type	Label	Value	Line	Idle	Connected	Incoming	Outgoing	Busy
	1	WebApps			global	<input checked="" type="checkbox"/>	<input checked="" type="checkbox"/>	<input checked="" type="checkbox"/>	<input checked="" type="checkbox"/>	<input checked="" type="checkbox"/>
	2	None			1	<input checked="" type="checkbox"/>	<input checked="" type="checkbox"/>	<input checked="" type="checkbox"/>	<input checked="" type="checkbox"/>	<input checked="" type="checkbox"/>
	3	None			1	<input checked="" type="checkbox"/>	<input checked="" type="checkbox"/>	<input checked="" type="checkbox"/>	<input checked="" type="checkbox"/>	<input checked="" type="checkbox"/>
	4	None			1	<input checked="" type="checkbox"/>	<input checked="" type="checkbox"/>	<input checked="" type="checkbox"/>	<input checked="" type="checkbox"/>	<input checked="" type="checkbox"/>
	5	None			1	<input checked="" type="checkbox"/>	<input checked="" type="checkbox"/>	<input checked="" type="checkbox"/>	<input checked="" type="checkbox"/>	<input checked="" type="checkbox"/>
	6	None			1	<input checked="" type="checkbox"/>	<input checked="" type="checkbox"/>	<input checked="" type="checkbox"/>	<input checked="" type="checkbox"/>	<input checked="" type="checkbox"/>
	7	None			1	<input checked="" type="checkbox"/>	<input checked="" type="checkbox"/>	<input checked="" type="checkbox"/>	<input checked="" type="checkbox"/>	<input checked="" type="checkbox"/>
	8	None			1	<input checked="" type="checkbox"/>	<input checked="" type="checkbox"/>	<input checked="" type="checkbox"/>	<input checked="" type="checkbox"/>	<input checked="" type="checkbox"/>
	9	None			1	<input checked="" type="checkbox"/>	<input checked="" type="checkbox"/>	<input checked="" type="checkbox"/>	<input checked="" type="checkbox"/>	<input checked="" type="checkbox"/>
	10	None			1	<input checked="" type="checkbox"/>	<input checked="" type="checkbox"/>	<input checked="" type="checkbox"/>	<input checked="" type="checkbox"/>	<input checked="" type="checkbox"/>
	11	None			1	<input checked="" type="checkbox"/>	<input checked="" type="checkbox"/>	<input checked="" type="checkbox"/>	<input checked="" type="checkbox"/>	<input checked="" type="checkbox"/>
	12	None			1	<input checked="" type="checkbox"/>	<input checked="" type="checkbox"/>	<input checked="" type="checkbox"/>	<input checked="" type="checkbox"/>	<input checked="" type="checkbox"/>
	13	None			1	<input checked="" type="checkbox"/>	<input checked="" type="checkbox"/>	<input checked="" type="checkbox"/>	<input checked="" type="checkbox"/>	<input checked="" type="checkbox"/>
	14	None			1	<input checked="" type="checkbox"/>	<input checked="" type="checkbox"/>	<input checked="" type="checkbox"/>	<input checked="" type="checkbox"/>	<input checked="" type="checkbox"/>
	15	None			1	<input checked="" type="checkbox"/>	<input checked="" type="checkbox"/>	<input checked="" type="checkbox"/>	<input checked="" type="checkbox"/>	<input checked="" type="checkbox"/>
	16	None			1	<input checked="" type="checkbox"/>	<input checked="" type="checkbox"/>	<input checked="" type="checkbox"/>	<input checked="" type="checkbox"/>	<input checked="" type="checkbox"/>
	17	None			1	<input checked="" type="checkbox"/>	<input checked="" type="checkbox"/>	<input checked="" type="checkbox"/>	<input checked="" type="checkbox"/>	<input checked="" type="checkbox"/>
	18	None			1	<input checked="" type="checkbox"/>	<input checked="" type="checkbox"/>	<input checked="" type="checkbox"/>	<input checked="" type="checkbox"/>	<input checked="" type="checkbox"/>
	19	None			1	<input checked="" type="checkbox"/>	<input checked="" type="checkbox"/>	<input checked="" type="checkbox"/>	<input checked="" type="checkbox"/>	<input checked="" type="checkbox"/>
	20	None			1	<input checked="" type="checkbox"/>	<input checked="" type="checkbox"/>	<input checked="" type="checkbox"/>	<input checked="" type="checkbox"/>	<input checked="" type="checkbox"/>
Services										
XML Application URI:					<input type="text"/>					
XML Application Title:					<input type="text"/>					
BLF List URI:					<input type="text"/>					

Softkeys

2. Select from "**Key 1**" through "**Key 20**".
3. In the "**Type**" field, select "**Flash**".
4. In the "**Label**" field, enter a label to display on the phone for the key.

Programmable Keys

5. Select from "**Key 1**" through "**Key 6**"
6. In the "**Type**" field, select "**Flash**".

Expansion Module Keys

7. Select from "**Key 1**" through "**Key 36**" (M670i)
or
Select from "**Key 1**" through "**Key 60**" (M675i)
8. In the "**Type**" field, select "**Flash**".
9. (M675i) In the "**Label**" field, enter a label to display on the phone for the key.
10. Click  to save your changes.

Sprecode Key

You can set a key to automatically activate specific services offered by the server by setting a key to "**sprecode**". For example, if the sprecode value of *82 is configured, then by pressing the key, *82 automatically activates a service provided by the server. The value you enter for this field is dependent on the services provided by the server. Contact your System Administrator for information about available services.

Configuring a Sprecode Key



Aastra Web UI

Use the following procedure to configure a Sprecode key on the 6755i IP Phone. The procedure shows the softkey screen as an example.

1. Click on **Operation->Softkeys and XML**.
or
Click on **Operation->Programmable Keys**.
or
Click on **Operation->Expansion Module <N>**.

Status		Softkeys Configuration									
System Information		Key	Type	Label	Value	Line	Idle	Connected	Incoming	Outgoing	Busy
Operation		1	WebApps			global	<input checked="" type="checkbox"/>	<input checked="" type="checkbox"/>	<input checked="" type="checkbox"/>	<input checked="" type="checkbox"/>	<input checked="" type="checkbox"/>
User Password		2	None			1	<input checked="" type="checkbox"/>	<input checked="" type="checkbox"/>	<input checked="" type="checkbox"/>	<input checked="" type="checkbox"/>	<input checked="" type="checkbox"/>
Phone Lock		3	None			1	<input checked="" type="checkbox"/>	<input checked="" type="checkbox"/>	<input checked="" type="checkbox"/>	<input checked="" type="checkbox"/>	<input checked="" type="checkbox"/>
Softkeys and XML		4	None			1	<input checked="" type="checkbox"/>	<input checked="" type="checkbox"/>	<input checked="" type="checkbox"/>	<input checked="" type="checkbox"/>	<input checked="" type="checkbox"/>
Programmable Keys		5	None			1	<input checked="" type="checkbox"/>	<input checked="" type="checkbox"/>	<input checked="" type="checkbox"/>	<input checked="" type="checkbox"/>	<input checked="" type="checkbox"/>
Keypad Speed Dial		6	None			1	<input checked="" type="checkbox"/>	<input checked="" type="checkbox"/>	<input checked="" type="checkbox"/>	<input checked="" type="checkbox"/>	<input checked="" type="checkbox"/>
Directory		7	None			1	<input checked="" type="checkbox"/>	<input checked="" type="checkbox"/>	<input checked="" type="checkbox"/>	<input checked="" type="checkbox"/>	<input checked="" type="checkbox"/>
Reset		8	None			1	<input checked="" type="checkbox"/>	<input checked="" type="checkbox"/>	<input checked="" type="checkbox"/>	<input checked="" type="checkbox"/>	<input checked="" type="checkbox"/>
Basic Settings		9	None			1	<input checked="" type="checkbox"/>	<input checked="" type="checkbox"/>	<input checked="" type="checkbox"/>	<input checked="" type="checkbox"/>	<input checked="" type="checkbox"/>
Preferences		10	None			1	<input checked="" type="checkbox"/>	<input checked="" type="checkbox"/>	<input checked="" type="checkbox"/>	<input checked="" type="checkbox"/>	<input checked="" type="checkbox"/>
Account Configuration		11	None			1	<input checked="" type="checkbox"/>	<input checked="" type="checkbox"/>	<input checked="" type="checkbox"/>	<input checked="" type="checkbox"/>	<input checked="" type="checkbox"/>
		12	None			1	<input checked="" type="checkbox"/>	<input checked="" type="checkbox"/>	<input checked="" type="checkbox"/>	<input checked="" type="checkbox"/>	<input checked="" type="checkbox"/>
		13	None			1	<input checked="" type="checkbox"/>	<input checked="" type="checkbox"/>	<input checked="" type="checkbox"/>	<input checked="" type="checkbox"/>	<input checked="" type="checkbox"/>
		14	None			1	<input checked="" type="checkbox"/>	<input checked="" type="checkbox"/>	<input checked="" type="checkbox"/>	<input checked="" type="checkbox"/>	<input checked="" type="checkbox"/>
		15	None			1	<input checked="" type="checkbox"/>	<input checked="" type="checkbox"/>	<input checked="" type="checkbox"/>	<input checked="" type="checkbox"/>	<input checked="" type="checkbox"/>
		16	None			1	<input checked="" type="checkbox"/>	<input checked="" type="checkbox"/>	<input checked="" type="checkbox"/>	<input checked="" type="checkbox"/>	<input checked="" type="checkbox"/>
		17	None			1	<input checked="" type="checkbox"/>	<input checked="" type="checkbox"/>	<input checked="" type="checkbox"/>	<input checked="" type="checkbox"/>	<input checked="" type="checkbox"/>
		18	None			1	<input checked="" type="checkbox"/>	<input checked="" type="checkbox"/>	<input checked="" type="checkbox"/>	<input checked="" type="checkbox"/>	<input checked="" type="checkbox"/>
		19	None			1	<input checked="" type="checkbox"/>	<input checked="" type="checkbox"/>	<input checked="" type="checkbox"/>	<input checked="" type="checkbox"/>	<input checked="" type="checkbox"/>
		20	None			1	<input checked="" type="checkbox"/>	<input checked="" type="checkbox"/>	<input checked="" type="checkbox"/>	<input checked="" type="checkbox"/>	<input checked="" type="checkbox"/>
		Services									
		XML Application URI:		<input type="text"/>							
		XML Application Title:		<input type="text"/>							
		BLF List URI:		<input type="text"/>							

Softkeys

2. Select from "**Key 1**" through "**Key 20**".
3. In the "**Type**" field, select **Sprecode**.
4. In the "**Label**" field, enter a label to display on the IP phone for this key.
5. In the "**Value**" field, enter the appropriate value for accessing specific services from the server.



Note: For values to enter in this field, contact your System Administrator.

6. In the state fields, check (enable) or uncheck (disable) the "**Connected**" state for this softkey.

Programmable Keys

7. Select from "**Key 1**" through "**Key 6**".
8. In the "**Type**" field, select **Sprecode**.
9. In the "**Value**" field, enter the appropriate value for accessing specific services from the server.



Note: For values to enter in this field, contact your System Administrator.

Expansion Module Keys

10. Select from "**Key 1**" through "**Key 36**" (M670i)
or
Select from "**Key 1**" through "**Key 60**" (M675i)
11. In the "**Type**" field, select **Sprecode**.
12. (M675i) In the "**Label**" field, enter a label to display on the IP phone for this key.
13. In the "**Value**" field, enter the appropriate value for accessing specific services from the server.



Note: For values to enter in this field, contact your System Administrator.

14. Click  to save your changes.

Park/Pickup Keys

The IP phone has a park and pickup call feature that allows you to park a call and pickup a call when required.

The IP phones support the Park/Pickup feature on the Asterisk, BroadWorks, Sylanro, and ININ PBX servers.

There are two ways a user can configure this feature:

- Using a static configuration
- Using a programmable configuration (using keys)



Note: The IP phone accepts both methods of configuration. However, to avoid redundancy, Aastra Telecom recommends you configure either a static configuration or a programmable configuration.

The following paragraphs describe the park and pickup methods of configuration on the IP phones.

Park/Pickup Static Configuration

You can configure a static configuration for parking and picking up a call using the Aastra Web UI at **Basic Settings->Preferences->General**.

Status System Information Operation User Password Phone Lock Softkeys and XML Programmable Keys Keypad Speed Dial Directory Reset Basic Settings Preferences Account Configuration	<h3>Preferences</h3> <p>General</p> Park Call: <input type="text"/> Pick Up Parked Call: <input type="text"/> Suppress DTMF Playback <input checked="" type="checkbox"/> Enabled Display DTMF Digits <input type="checkbox"/> Enabled Call Waiting <input checked="" type="checkbox"/> Enabled Play Call Waiting Tone <input checked="" type="checkbox"/> Enabled Stuttered Dial Tone <input checked="" type="checkbox"/> Enabled XML Beep Support <input checked="" type="checkbox"/> Enabled Status Scroll Delay (seconds) <input type="text" value="5"/> Incoming Call Interrupts Dialing <input type="checkbox"/> Enabled Switch UI Focus To Ringing Line <input checked="" type="checkbox"/> Enabled Preferred line <input type="text" value="1"/> Preferred line Timeout (seconds) <input type="text" value="0"/> Goodbye Key Cancels Incoming Call <input checked="" type="checkbox"/> Enabled UPnP Mapping Lines <input type="text" value="0"/> Message Waiting Indicator Line <input type="text" value="All"/> DND Key Mode <input type="text" value="Phone"/> Call Forward Key Mode <input type="text" value="Account"/> Use LLDP ELIN <input checked="" type="checkbox"/> Enabled
---	---

By entering the appropriate value in the "**Park Call**" and "**Pickup Parked Call**" fields, you tell the phone where to park a live call and where to pickup the parked call.

On the IP phone UI, the static configuration method displays the following:

- When a call comes in, and you pickup the handset, the default label of "**Park**" displays on the Phone UI.
- After pressing the "**Park**" key to park the call, the default label of "**Pickup**" displays on the phone UI.

The values you enter in the Aastra Web UI for the Park/Pickup call feature are dependant on your type of server. The following table provides the values you enter for the "**Park Call**" and "**Pickup Parked Call**" fields in the Aastra Web UI.

Park/Pickup Call Server Configuration Values

Server	Park Values*	Pickup Values*
Asterisk	700	700
Sylantro	*98	*99
BroadWorks	*68	*88
ININ PBX	callpark	pickup

*Leave "value" fields blank to disable the park and pickup feature.

Configuring Park /Pickup using Static Configuration

Use the following procedure to configure the Park/Pickup call feature using the static configuration method.



Note: Aastra recommends you configure either the static or the programmable configuration, but not both.



Aastra Web UI

1. Click on **Basic Settings->Preferences->General**.

<p>Status</p> <ul style="list-style-type: none"> System Information <p>Operation</p> <ul style="list-style-type: none"> User Password Phone Lock Softkeys and XML Programmable Keys Keypad Speed Dial Directory Reset <p>Basic Settings</p> <ul style="list-style-type: none"> Preferences Account Configuration 	<p>Preferences</p> <p>General</p> <p>Park Call: <input type="text"/></p> <p>Pick Up Parked Call: <input type="text"/></p> <p>Suppress DTMF Playback <input checked="" type="checkbox"/> Enabled</p> <p>Display DTMF Digits <input type="checkbox"/> Enabled</p> <p>Call Waiting <input checked="" type="checkbox"/> Enabled</p> <p>Play Call Waiting Tone <input checked="" type="checkbox"/> Enabled</p> <p>Stuttered Dial Tone <input checked="" type="checkbox"/> Enabled</p> <p>XML Beep Support <input checked="" type="checkbox"/> Enabled</p> <p>Status Scroll Delay (seconds) <input type="text" value="5"/></p> <p>Incoming Call Interrupts Dialing <input type="checkbox"/> Enabled</p> <p>Switch UI Focus To Ringing Line <input checked="" type="checkbox"/> Enabled</p> <p>Preferred line <input type="text" value="1"/></p> <p>Preferred line Timeout (seconds) <input type="text" value="0"/></p> <p>Goodbye Key Cancels Incoming Call <input checked="" type="checkbox"/> Enabled</p> <p>UPnP Mapping Lines <input type="text" value="0"/></p> <p>Message Waiting Indicator Line <input type="text" value="All"/></p> <p>DND Key Mode <input type="text" value="Phone"/></p> <p>Call Forward Key Mode <input type="text" value="Account"/></p> <p>Use LLDP ELIN <input checked="" type="checkbox"/> Enabled</p>
---	---

2. Enter a server value in the **Park Call** field to which incoming live calls are parked.



Note: For values to enter in this field, see the table “[Park/Pickup Call Server Configuration Values](#)” on page 113.

3. Enter a server value in the "**Pickup Parked Call**" field.



Note: For values to enter in this field, see the table “[Park/Pickup Call Server Configuration Values](#)” on page 113.

4. Click  to save your changes.

Park/Pickup Key Configuration

The programmable method of configuration creates park and pickup keys that you can configure on the 6755i phone.

You can set a key as "Park" or "Pickup" and then:

- specify a customized label to display on the Phone UI
- specify a value
- specify which line to use
- specify the state of the park and/or pickup keys

On the IP phone UI, the Park/Pickup feature displays the following:

- When a call comes in, and you pickup the handset, the custom label that you configured for the Park key displays on the Phone UI.
- After the call is parked, the label that you configured for the Pickup key displays on other phones in the network. You can then press the "Pickup" key, followed by the applicable value to pickup the call on another phone in your network.

You can configure a Park and Pickup programmable configuration using the Aastra Web UI.

Key Configuration Using the Aastra Web UI

On the 6755i, you configure a Park and/or Pickup key at **Operation->Softkeys and XML**. You enter a key label, and value for a specific line on the phone. The default state of the Park configuration is "**connected**". The default state of the Pickup configuration is "**idle, outgoing**".



Note: Applicable values depend on the server in your network (Asterisk, BroadWorks, Sylanro, ININ PBX. See the table "[Park/Pickup Call Server Configuration Values](#)" on [page 113](#)).

Configuring Park/Pickup using Key Configuration

Use the following procedure to configure the Park/Pickup call feature using the key configuration method.



Aastra Web UI

Use the following procedure to configure a Park/Pickup key on the 6755i IP Phone. The procedure shows the softkey screen as an example.



Note: For values to enter in the "**Value**" fields, see the table "[Park/Pickup Call Server Configuration Values](#)" on [page 113](#).

1. Click on **Operation->Softkeys and XML**.
or
Click on **Operation->Programmable Keys**.
or
Click on **Operation->Expansion Module <N>**.

<p>Status</p> <p>System Information</p> <p>Operation</p> <p>User Password</p> <p>Phone Lock</p> <p>Softkeys and XML</p> <p>Programmable Keys</p> <p>Keypad Speed Dial</p> <p>Directory</p> <p>Reset</p> <p>Basic Settings</p> <p>Preferences</p> <p>Account Configuration</p>	<p style="text-align: center;">Softkeys Configuration</p> <table border="1"> <thead> <tr> <th>Key</th> <th>Type</th> <th>Label</th> <th>Value</th> <th>Line</th> <th>Idle</th> <th>Connected</th> <th>Incoming</th> <th>Outgoing</th> <th>Busy</th> </tr> </thead> <tbody> <tr> <td>1</td> <td>WebApps</td> <td></td> <td></td> <td>global</td> <td><input checked="" type="checkbox"/></td> <td><input checked="" type="checkbox"/></td> <td><input checked="" type="checkbox"/></td> <td><input checked="" type="checkbox"/></td> <td><input checked="" type="checkbox"/></td> </tr> <tr> <td>2</td> <td>None</td> <td></td> <td></td> <td>1</td> <td><input checked="" type="checkbox"/></td> <td><input checked="" type="checkbox"/></td> <td><input checked="" type="checkbox"/></td> <td><input checked="" type="checkbox"/></td> <td><input checked="" type="checkbox"/></td> </tr> <tr> <td>3</td> <td>None</td> <td></td> <td></td> <td>1</td> <td><input checked="" type="checkbox"/></td> <td><input checked="" type="checkbox"/></td> <td><input checked="" type="checkbox"/></td> <td><input checked="" type="checkbox"/></td> <td><input checked="" type="checkbox"/></td> </tr> <tr> <td>4</td> <td>None</td> <td></td> <td></td> <td>1</td> <td><input checked="" type="checkbox"/></td> <td><input checked="" type="checkbox"/></td> <td><input checked="" type="checkbox"/></td> <td><input checked="" type="checkbox"/></td> <td><input checked="" type="checkbox"/></td> </tr> <tr> <td>5</td> <td>None</td> <td></td> <td></td> <td>1</td> <td><input checked="" type="checkbox"/></td> <td><input checked="" type="checkbox"/></td> <td><input checked="" type="checkbox"/></td> <td><input checked="" type="checkbox"/></td> <td><input checked="" type="checkbox"/></td> </tr> <tr> <td>6</td> <td>None</td> <td></td> <td></td> <td>1</td> <td><input checked="" type="checkbox"/></td> <td><input checked="" type="checkbox"/></td> <td><input checked="" type="checkbox"/></td> <td><input checked="" type="checkbox"/></td> <td><input checked="" type="checkbox"/></td> </tr> <tr> <td>7</td> <td>None</td> <td></td> <td></td> <td>1</td> <td><input checked="" type="checkbox"/></td> <td><input checked="" type="checkbox"/></td> <td><input checked="" type="checkbox"/></td> <td><input checked="" type="checkbox"/></td> <td><input checked="" type="checkbox"/></td> </tr> <tr> <td>8</td> <td>None</td> <td></td> <td></td> <td>1</td> <td><input checked="" type="checkbox"/></td> <td><input checked="" type="checkbox"/></td> <td><input checked="" type="checkbox"/></td> <td><input checked="" type="checkbox"/></td> <td><input checked="" type="checkbox"/></td> </tr> <tr> <td>9</td> <td>None</td> <td></td> <td></td> <td>1</td> <td><input checked="" type="checkbox"/></td> <td><input checked="" type="checkbox"/></td> <td><input checked="" type="checkbox"/></td> <td><input checked="" type="checkbox"/></td> <td><input checked="" type="checkbox"/></td> </tr> <tr> <td>10</td> <td>None</td> <td></td> <td></td> <td>1</td> <td><input checked="" type="checkbox"/></td> <td><input checked="" type="checkbox"/></td> <td><input checked="" type="checkbox"/></td> <td><input checked="" type="checkbox"/></td> <td><input checked="" type="checkbox"/></td> </tr> <tr> <td>11</td> <td>None</td> <td></td> <td></td> <td>1</td> <td><input checked="" type="checkbox"/></td> <td><input checked="" type="checkbox"/></td> <td><input checked="" type="checkbox"/></td> <td><input checked="" type="checkbox"/></td> <td><input checked="" type="checkbox"/></td> </tr> <tr> <td>12</td> <td>None</td> <td></td> <td></td> <td>1</td> <td><input checked="" type="checkbox"/></td> <td><input checked="" type="checkbox"/></td> <td><input checked="" type="checkbox"/></td> <td><input checked="" type="checkbox"/></td> <td><input checked="" type="checkbox"/></td> </tr> <tr> <td>13</td> <td>None</td> <td></td> <td></td> <td>1</td> <td><input checked="" type="checkbox"/></td> <td><input checked="" type="checkbox"/></td> <td><input checked="" type="checkbox"/></td> <td><input checked="" type="checkbox"/></td> <td><input checked="" type="checkbox"/></td> </tr> <tr> <td>14</td> <td>None</td> <td></td> <td></td> <td>1</td> <td><input checked="" type="checkbox"/></td> <td><input checked="" type="checkbox"/></td> <td><input checked="" type="checkbox"/></td> <td><input checked="" type="checkbox"/></td> <td><input checked="" type="checkbox"/></td> </tr> <tr> <td>15</td> <td>None</td> <td></td> <td></td> <td>1</td> <td><input checked="" type="checkbox"/></td> <td><input checked="" type="checkbox"/></td> <td><input checked="" type="checkbox"/></td> <td><input checked="" type="checkbox"/></td> <td><input checked="" type="checkbox"/></td> </tr> <tr> <td>16</td> <td>None</td> <td></td> <td></td> <td>1</td> <td><input checked="" type="checkbox"/></td> <td><input checked="" type="checkbox"/></td> <td><input checked="" type="checkbox"/></td> <td><input checked="" type="checkbox"/></td> <td><input checked="" type="checkbox"/></td> </tr> <tr> <td>17</td> <td>None</td> <td></td> <td></td> <td>1</td> <td><input checked="" type="checkbox"/></td> <td><input checked="" type="checkbox"/></td> <td><input checked="" type="checkbox"/></td> <td><input checked="" type="checkbox"/></td> <td><input checked="" type="checkbox"/></td> </tr> <tr> <td>18</td> <td>None</td> <td></td> <td></td> <td>1</td> <td><input checked="" type="checkbox"/></td> <td><input checked="" type="checkbox"/></td> <td><input checked="" type="checkbox"/></td> <td><input checked="" type="checkbox"/></td> <td><input checked="" type="checkbox"/></td> </tr> <tr> <td>19</td> <td>None</td> <td></td> <td></td> <td>1</td> <td><input checked="" type="checkbox"/></td> <td><input checked="" type="checkbox"/></td> <td><input checked="" type="checkbox"/></td> <td><input checked="" type="checkbox"/></td> <td><input checked="" type="checkbox"/></td> </tr> <tr> <td>20</td> <td>None</td> <td></td> <td></td> <td>1</td> <td><input checked="" type="checkbox"/></td> <td><input checked="" type="checkbox"/></td> <td><input checked="" type="checkbox"/></td> <td><input checked="" type="checkbox"/></td> <td><input checked="" type="checkbox"/></td> </tr> </tbody> </table> <p>Services</p> <p>XML Application URI: <input type="text"/></p> <p>XML Application Title: <input type="text"/></p> <p>BLF List URI: <input type="text"/></p>	Key	Type	Label	Value	Line	Idle	Connected	Incoming	Outgoing	Busy	1	WebApps			global	<input checked="" type="checkbox"/>	<input checked="" type="checkbox"/>	<input checked="" type="checkbox"/>	<input checked="" type="checkbox"/>	<input checked="" type="checkbox"/>	2	None			1	<input checked="" type="checkbox"/>	<input checked="" type="checkbox"/>	<input checked="" type="checkbox"/>	<input checked="" type="checkbox"/>	<input checked="" type="checkbox"/>	3	None			1	<input checked="" type="checkbox"/>	<input checked="" type="checkbox"/>	<input checked="" type="checkbox"/>	<input checked="" type="checkbox"/>	<input checked="" type="checkbox"/>	4	None			1	<input checked="" type="checkbox"/>	<input checked="" type="checkbox"/>	<input checked="" type="checkbox"/>	<input checked="" type="checkbox"/>	<input checked="" type="checkbox"/>	5	None			1	<input checked="" type="checkbox"/>	<input checked="" type="checkbox"/>	<input checked="" type="checkbox"/>	<input checked="" type="checkbox"/>	<input checked="" type="checkbox"/>	6	None			1	<input checked="" type="checkbox"/>	<input checked="" type="checkbox"/>	<input checked="" type="checkbox"/>	<input checked="" type="checkbox"/>	<input checked="" type="checkbox"/>	7	None			1	<input checked="" type="checkbox"/>	<input checked="" type="checkbox"/>	<input checked="" type="checkbox"/>	<input checked="" type="checkbox"/>	<input checked="" type="checkbox"/>	8	None			1	<input checked="" type="checkbox"/>	<input checked="" type="checkbox"/>	<input checked="" type="checkbox"/>	<input checked="" type="checkbox"/>	<input checked="" type="checkbox"/>	9	None			1	<input checked="" type="checkbox"/>	<input checked="" type="checkbox"/>	<input checked="" type="checkbox"/>	<input checked="" type="checkbox"/>	<input checked="" type="checkbox"/>	10	None			1	<input checked="" type="checkbox"/>	<input checked="" type="checkbox"/>	<input checked="" type="checkbox"/>	<input checked="" type="checkbox"/>	<input checked="" type="checkbox"/>	11	None			1	<input checked="" type="checkbox"/>	<input checked="" type="checkbox"/>	<input checked="" type="checkbox"/>	<input checked="" type="checkbox"/>	<input checked="" type="checkbox"/>	12	None			1	<input checked="" type="checkbox"/>	<input checked="" type="checkbox"/>	<input checked="" type="checkbox"/>	<input checked="" type="checkbox"/>	<input checked="" type="checkbox"/>	13	None			1	<input checked="" type="checkbox"/>	<input checked="" type="checkbox"/>	<input checked="" type="checkbox"/>	<input checked="" type="checkbox"/>	<input checked="" type="checkbox"/>	14	None			1	<input checked="" type="checkbox"/>	<input checked="" type="checkbox"/>	<input checked="" type="checkbox"/>	<input checked="" type="checkbox"/>	<input checked="" type="checkbox"/>	15	None			1	<input checked="" type="checkbox"/>	<input checked="" type="checkbox"/>	<input checked="" type="checkbox"/>	<input checked="" type="checkbox"/>	<input checked="" type="checkbox"/>	16	None			1	<input checked="" type="checkbox"/>	<input checked="" type="checkbox"/>	<input checked="" type="checkbox"/>	<input checked="" type="checkbox"/>	<input checked="" type="checkbox"/>	17	None			1	<input checked="" type="checkbox"/>	<input checked="" type="checkbox"/>	<input checked="" type="checkbox"/>	<input checked="" type="checkbox"/>	<input checked="" type="checkbox"/>	18	None			1	<input checked="" type="checkbox"/>	<input checked="" type="checkbox"/>	<input checked="" type="checkbox"/>	<input checked="" type="checkbox"/>	<input checked="" type="checkbox"/>	19	None			1	<input checked="" type="checkbox"/>	<input checked="" type="checkbox"/>	<input checked="" type="checkbox"/>	<input checked="" type="checkbox"/>	<input checked="" type="checkbox"/>	20	None			1	<input checked="" type="checkbox"/>	<input checked="" type="checkbox"/>	<input checked="" type="checkbox"/>	<input checked="" type="checkbox"/>	<input checked="" type="checkbox"/>
Key	Type	Label	Value	Line	Idle	Connected	Incoming	Outgoing	Busy																																																																																																																																																																																																										
1	WebApps			global	<input checked="" type="checkbox"/>	<input checked="" type="checkbox"/>	<input checked="" type="checkbox"/>	<input checked="" type="checkbox"/>	<input checked="" type="checkbox"/>																																																																																																																																																																																																										
2	None			1	<input checked="" type="checkbox"/>	<input checked="" type="checkbox"/>	<input checked="" type="checkbox"/>	<input checked="" type="checkbox"/>	<input checked="" type="checkbox"/>																																																																																																																																																																																																										
3	None			1	<input checked="" type="checkbox"/>	<input checked="" type="checkbox"/>	<input checked="" type="checkbox"/>	<input checked="" type="checkbox"/>	<input checked="" type="checkbox"/>																																																																																																																																																																																																										
4	None			1	<input checked="" type="checkbox"/>	<input checked="" type="checkbox"/>	<input checked="" type="checkbox"/>	<input checked="" type="checkbox"/>	<input checked="" type="checkbox"/>																																																																																																																																																																																																										
5	None			1	<input checked="" type="checkbox"/>	<input checked="" type="checkbox"/>	<input checked="" type="checkbox"/>	<input checked="" type="checkbox"/>	<input checked="" type="checkbox"/>																																																																																																																																																																																																										
6	None			1	<input checked="" type="checkbox"/>	<input checked="" type="checkbox"/>	<input checked="" type="checkbox"/>	<input checked="" type="checkbox"/>	<input checked="" type="checkbox"/>																																																																																																																																																																																																										
7	None			1	<input checked="" type="checkbox"/>	<input checked="" type="checkbox"/>	<input checked="" type="checkbox"/>	<input checked="" type="checkbox"/>	<input checked="" type="checkbox"/>																																																																																																																																																																																																										
8	None			1	<input checked="" type="checkbox"/>	<input checked="" type="checkbox"/>	<input checked="" type="checkbox"/>	<input checked="" type="checkbox"/>	<input checked="" type="checkbox"/>																																																																																																																																																																																																										
9	None			1	<input checked="" type="checkbox"/>	<input checked="" type="checkbox"/>	<input checked="" type="checkbox"/>	<input checked="" type="checkbox"/>	<input checked="" type="checkbox"/>																																																																																																																																																																																																										
10	None			1	<input checked="" type="checkbox"/>	<input checked="" type="checkbox"/>	<input checked="" type="checkbox"/>	<input checked="" type="checkbox"/>	<input checked="" type="checkbox"/>																																																																																																																																																																																																										
11	None			1	<input checked="" type="checkbox"/>	<input checked="" type="checkbox"/>	<input checked="" type="checkbox"/>	<input checked="" type="checkbox"/>	<input checked="" type="checkbox"/>																																																																																																																																																																																																										
12	None			1	<input checked="" type="checkbox"/>	<input checked="" type="checkbox"/>	<input checked="" type="checkbox"/>	<input checked="" type="checkbox"/>	<input checked="" type="checkbox"/>																																																																																																																																																																																																										
13	None			1	<input checked="" type="checkbox"/>	<input checked="" type="checkbox"/>	<input checked="" type="checkbox"/>	<input checked="" type="checkbox"/>	<input checked="" type="checkbox"/>																																																																																																																																																																																																										
14	None			1	<input checked="" type="checkbox"/>	<input checked="" type="checkbox"/>	<input checked="" type="checkbox"/>	<input checked="" type="checkbox"/>	<input checked="" type="checkbox"/>																																																																																																																																																																																																										
15	None			1	<input checked="" type="checkbox"/>	<input checked="" type="checkbox"/>	<input checked="" type="checkbox"/>	<input checked="" type="checkbox"/>	<input checked="" type="checkbox"/>																																																																																																																																																																																																										
16	None			1	<input checked="" type="checkbox"/>	<input checked="" type="checkbox"/>	<input checked="" type="checkbox"/>	<input checked="" type="checkbox"/>	<input checked="" type="checkbox"/>																																																																																																																																																																																																										
17	None			1	<input checked="" type="checkbox"/>	<input checked="" type="checkbox"/>	<input checked="" type="checkbox"/>	<input checked="" type="checkbox"/>	<input checked="" type="checkbox"/>																																																																																																																																																																																																										
18	None			1	<input checked="" type="checkbox"/>	<input checked="" type="checkbox"/>	<input checked="" type="checkbox"/>	<input checked="" type="checkbox"/>	<input checked="" type="checkbox"/>																																																																																																																																																																																																										
19	None			1	<input checked="" type="checkbox"/>	<input checked="" type="checkbox"/>	<input checked="" type="checkbox"/>	<input checked="" type="checkbox"/>	<input checked="" type="checkbox"/>																																																																																																																																																																																																										
20	None			1	<input checked="" type="checkbox"/>	<input checked="" type="checkbox"/>	<input checked="" type="checkbox"/>	<input checked="" type="checkbox"/>	<input checked="" type="checkbox"/>																																																																																																																																																																																																										

Softkeys

2. Select from "Key 1" through "Key 20".
3. In the "Type" field, select **Park**.
4. In the "Label" field, enter a label for the Park key.
5. In the "Value" field, enter the appropriate value based on the server in your network.
6. In the "Line" field, select a line for which to apply the Park configuration.
7. In the state fields, check (enable) or uncheck (disable) the "Connected" state for this softkey.
8. Select another key to configure for Picking up a call.
9. In the "Label" field, enter a label for the Pickup key.
10. In the "Value" field, enter the appropriate value based on the server in your network.
11. In the "Line" field, select a line for which to apply the Pickup configuration.
12. In the state fields, check (enable) or uncheck (disable) the "Idle" and "Outgoing" states for this softkey.

Programmable Keys

13. Select from "**Key 1**" through "**Key 6**"
14. In the "**Type**" field, select **Park**.
15. In the "**Value**" field, enter the appropriate value based on the server in your network.
16. In the "**Line**" field, select a line for which to apply the Park configuration.
17. Select another key to configure for Picking up a call.
18. In the "**Value**" field, enter the appropriate value based on the server in your network.
19. In the "**Line**" field, select a line for which to apply the Pickup configuration.

Expansion Module Keys

20. Select from "**Key 1**" through "**Key 36**" (M670i)
or
Select from "**Key 1**" through "**Key 60**" (M675i)
21. In the "**Type**" field, select **Park**.
22. (M675i) In the "**Label**" field, enter a label for the Park key.
23. In the "**Value**" field, enter the appropriate value based on the server in your network.
24. In the "**Line**" field, select a line for which to apply the Park configuration.
25. Select another key to configure for Picking up a call.
26. (M675i) In the "**Label**" field, enter a label for the Pickup key.
27. In the "**Value**" field, enter the appropriate value based on the server in your network.
28. In the "**Line**" field, select a line for which to apply the Pickup configuration.
29. Click  to save your changes.

Using the Park Call/Pickup Parked Call Feature

Use the following procedure on the IP phones to park a call and pick up a parked call.

Park a Call

1. While on a live call, press the "**Park**" key.
2. Perform the following for your specific server:

For Asterisk Server
Server announces the extension number where the call has been parked. Once the call is parked, press the y key to complete parking.
For BroadWorks Server
After you hear the greeting from the CallPark server, enter the extension where you want to park the call.
For Sylanro Server
Enter the extension number where you want to park the call, followed by " # " key.
For ININ Server
Enter the extension number where you want to park the call, followed by " # " key.

If the call is parked successfully, the response is either a greeting voice confirming that the call was parked, or a hang up occurs. The parked call party hears music on hold.

3. If the call fails, you can pick up the call (using the next procedure) and press the "**Park**" key again to retry step 2.

Pickup a Parked Call

1. Pick up the handset on the phone.
2. Enter the extension number where the call was parked.
3. Press the "**Pickup**" key.

If the call pick up is successful, you are connected with the parked call.

Last Call Return (lcr) Key (Sylantro Servers only)

Using the Aastra Web UI, you can configure the "Last call return" (lcr) function on a key. This feature is for Sylantro servers only.

How it works

If you configure "lcr" on a key, and a call comes into your phone, after you are finished with the call and hang up, you can press the key configured for "lcr" and the phone dials the last call you received. When you configure an "lcr" key, the label "LCR" displays next to that key on the IP phone. When the Sylantro server detects an "lcr" request, it translates this request and routes the call to the last caller.

Configuring a Last Call Return Key

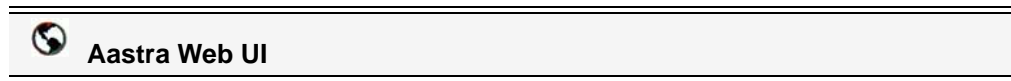

Use the following procedure to configure a Last Call Return key on the 6755i IP Phone. The procedure shows the softkey screen as an example.

1. Click on **Operation->Softkeys and XML**.
or
Click on **Operation->Programmable Keys**.
or
Click on **Operation->Expansion Module <N>**.

Key	Type	Label	Value	Line	Idle	Connected	Incoming	Outgoing	Busy
1	WebApps			global	<input checked="" type="checkbox"/>	<input checked="" type="checkbox"/>	<input checked="" type="checkbox"/>	<input checked="" type="checkbox"/>	<input checked="" type="checkbox"/>
2	None			1	<input checked="" type="checkbox"/>	<input checked="" type="checkbox"/>	<input checked="" type="checkbox"/>	<input checked="" type="checkbox"/>	<input checked="" type="checkbox"/>
3	None			1	<input checked="" type="checkbox"/>	<input checked="" type="checkbox"/>	<input checked="" type="checkbox"/>	<input checked="" type="checkbox"/>	<input checked="" type="checkbox"/>
4	None			1	<input checked="" type="checkbox"/>	<input checked="" type="checkbox"/>	<input checked="" type="checkbox"/>	<input checked="" type="checkbox"/>	<input checked="" type="checkbox"/>
5	None			1	<input checked="" type="checkbox"/>	<input checked="" type="checkbox"/>	<input checked="" type="checkbox"/>	<input checked="" type="checkbox"/>	<input checked="" type="checkbox"/>
6	None			1	<input checked="" type="checkbox"/>	<input checked="" type="checkbox"/>	<input checked="" type="checkbox"/>	<input checked="" type="checkbox"/>	<input checked="" type="checkbox"/>
7	None			1	<input checked="" type="checkbox"/>	<input checked="" type="checkbox"/>	<input checked="" type="checkbox"/>	<input checked="" type="checkbox"/>	<input checked="" type="checkbox"/>
8	None			1	<input checked="" type="checkbox"/>	<input checked="" type="checkbox"/>	<input checked="" type="checkbox"/>	<input checked="" type="checkbox"/>	<input checked="" type="checkbox"/>
9	None			1	<input checked="" type="checkbox"/>	<input checked="" type="checkbox"/>	<input checked="" type="checkbox"/>	<input checked="" type="checkbox"/>	<input checked="" type="checkbox"/>
10	None			1	<input checked="" type="checkbox"/>	<input checked="" type="checkbox"/>	<input checked="" type="checkbox"/>	<input checked="" type="checkbox"/>	<input checked="" type="checkbox"/>
11	None			1	<input checked="" type="checkbox"/>	<input checked="" type="checkbox"/>	<input checked="" type="checkbox"/>	<input checked="" type="checkbox"/>	<input checked="" type="checkbox"/>
12	None			1	<input checked="" type="checkbox"/>	<input checked="" type="checkbox"/>	<input checked="" type="checkbox"/>	<input checked="" type="checkbox"/>	<input checked="" type="checkbox"/>
13	None			1	<input checked="" type="checkbox"/>	<input checked="" type="checkbox"/>	<input checked="" type="checkbox"/>	<input checked="" type="checkbox"/>	<input checked="" type="checkbox"/>
14	None			1	<input checked="" type="checkbox"/>	<input checked="" type="checkbox"/>	<input checked="" type="checkbox"/>	<input checked="" type="checkbox"/>	<input checked="" type="checkbox"/>
15	None			1	<input checked="" type="checkbox"/>	<input checked="" type="checkbox"/>	<input checked="" type="checkbox"/>	<input checked="" type="checkbox"/>	<input checked="" type="checkbox"/>
16	None			1	<input checked="" type="checkbox"/>	<input checked="" type="checkbox"/>	<input checked="" type="checkbox"/>	<input checked="" type="checkbox"/>	<input checked="" type="checkbox"/>
17	None			1	<input checked="" type="checkbox"/>	<input checked="" type="checkbox"/>	<input checked="" type="checkbox"/>	<input checked="" type="checkbox"/>	<input checked="" type="checkbox"/>
18	None			1	<input checked="" type="checkbox"/>	<input checked="" type="checkbox"/>	<input checked="" type="checkbox"/>	<input checked="" type="checkbox"/>	<input checked="" type="checkbox"/>
19	None			1	<input checked="" type="checkbox"/>	<input checked="" type="checkbox"/>	<input checked="" type="checkbox"/>	<input checked="" type="checkbox"/>	<input checked="" type="checkbox"/>
20	None			1	<input checked="" type="checkbox"/>	<input checked="" type="checkbox"/>	<input checked="" type="checkbox"/>	<input checked="" type="checkbox"/>	<input checked="" type="checkbox"/>

Services

XML Application URI:

XML Application Title:

BLF List URI:

Softkeys

2. Select from "**Key 1**" through "**Key 20**".
3. In the "**Type**" field, select **Last Call Return**.
4. In the "**Line**" field, select the line you want to apply to this key.
Valid values are **1** through **9**.
5. In the state fields, check (enable) or uncheck (disable) the states you want to apply to this softkey.

Programmable Keys

6. Select from "**Key 1**" through "**Key 6**".
7. In the "**Type**" field, select **Last Call Return**.
8. In the "**Line**" field, select the line you want to apply to this key.
Valid values are **1** through **9**.

Expansion Module Keys

9. Select from "**Key 1**" through "**Key 36**" (M670i)
or
Select from "**Key 1**" through "**Key 60**" (M675i)
10. In the "**Type**" field, select **Last Call Return**.
11. In the "**Line**" field, select the line you want to apply to this key.
Valid values are **1** through **9**.
12. Click  to save your changes.

Call Forward Key

Using the Aastra Web UI, you can configure the **Call Forward** (CFWD) function on a softkey, programmable key, or expansion module key. Use call forwarding when you want a specific account on your phone to be forwarded to another number when your phone is in the busy state or the no answer state, or both. Pressing the Call Forward key on the phone accesses the Call Forward Menus. The menus that display are dependant on the Call Forward mode (**Account** (default), **Phone**, or **Custom**) configured for the phone.

For more information about call forwarding and call forwarding modes, see [“Call Forward Account-Based Configuration”](#) on page 193.

Configuring a Call Forward Key

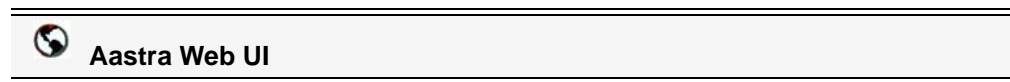

1. Click on **Operation->Softkeys and XML**.
or
Click on **Operation->Programmable Keys**.
or
Click on **Operation->Expansion Module <N>**.

Key	Type	Label	Value	Line	Idle	Connected	Incoming	Outgoing	Busy
1	WebApps			global	<input checked="" type="checkbox"/>	<input checked="" type="checkbox"/>	<input checked="" type="checkbox"/>	<input checked="" type="checkbox"/>	<input checked="" type="checkbox"/>
2	None			1	<input checked="" type="checkbox"/>	<input checked="" type="checkbox"/>	<input checked="" type="checkbox"/>	<input checked="" type="checkbox"/>	<input checked="" type="checkbox"/>
3	None			1	<input checked="" type="checkbox"/>	<input checked="" type="checkbox"/>	<input checked="" type="checkbox"/>	<input checked="" type="checkbox"/>	<input checked="" type="checkbox"/>
4	None			1	<input checked="" type="checkbox"/>	<input checked="" type="checkbox"/>	<input checked="" type="checkbox"/>	<input checked="" type="checkbox"/>	<input checked="" type="checkbox"/>
5	None			1	<input checked="" type="checkbox"/>	<input checked="" type="checkbox"/>	<input checked="" type="checkbox"/>	<input checked="" type="checkbox"/>	<input checked="" type="checkbox"/>
6	None			1	<input checked="" type="checkbox"/>	<input checked="" type="checkbox"/>	<input checked="" type="checkbox"/>	<input checked="" type="checkbox"/>	<input checked="" type="checkbox"/>
7	None			1	<input checked="" type="checkbox"/>	<input checked="" type="checkbox"/>	<input checked="" type="checkbox"/>	<input checked="" type="checkbox"/>	<input checked="" type="checkbox"/>
8	None			1	<input checked="" type="checkbox"/>	<input checked="" type="checkbox"/>	<input checked="" type="checkbox"/>	<input checked="" type="checkbox"/>	<input checked="" type="checkbox"/>
9	None			1	<input checked="" type="checkbox"/>	<input checked="" type="checkbox"/>	<input checked="" type="checkbox"/>	<input checked="" type="checkbox"/>	<input checked="" type="checkbox"/>
10	None			1	<input checked="" type="checkbox"/>	<input checked="" type="checkbox"/>	<input checked="" type="checkbox"/>	<input checked="" type="checkbox"/>	<input checked="" type="checkbox"/>
11	None			1	<input checked="" type="checkbox"/>	<input checked="" type="checkbox"/>	<input checked="" type="checkbox"/>	<input checked="" type="checkbox"/>	<input checked="" type="checkbox"/>
12	None			1	<input checked="" type="checkbox"/>	<input checked="" type="checkbox"/>	<input checked="" type="checkbox"/>	<input checked="" type="checkbox"/>	<input checked="" type="checkbox"/>
13	None			1	<input checked="" type="checkbox"/>	<input checked="" type="checkbox"/>	<input checked="" type="checkbox"/>	<input checked="" type="checkbox"/>	<input checked="" type="checkbox"/>
14	None			1	<input checked="" type="checkbox"/>	<input checked="" type="checkbox"/>	<input checked="" type="checkbox"/>	<input checked="" type="checkbox"/>	<input checked="" type="checkbox"/>
15	None			1	<input checked="" type="checkbox"/>	<input checked="" type="checkbox"/>	<input checked="" type="checkbox"/>	<input checked="" type="checkbox"/>	<input checked="" type="checkbox"/>
16	None			1	<input checked="" type="checkbox"/>	<input checked="" type="checkbox"/>	<input checked="" type="checkbox"/>	<input checked="" type="checkbox"/>	<input checked="" type="checkbox"/>
17	None			1	<input checked="" type="checkbox"/>	<input checked="" type="checkbox"/>	<input checked="" type="checkbox"/>	<input checked="" type="checkbox"/>	<input checked="" type="checkbox"/>
18	None			1	<input checked="" type="checkbox"/>	<input checked="" type="checkbox"/>	<input checked="" type="checkbox"/>	<input checked="" type="checkbox"/>	<input checked="" type="checkbox"/>
19	None			1	<input checked="" type="checkbox"/>	<input checked="" type="checkbox"/>	<input checked="" type="checkbox"/>	<input checked="" type="checkbox"/>	<input checked="" type="checkbox"/>
20	None			1	<input checked="" type="checkbox"/>	<input checked="" type="checkbox"/>	<input checked="" type="checkbox"/>	<input checked="" type="checkbox"/>	<input checked="" type="checkbox"/>

Services	
XML Application URI:	<input type="text"/>
XML Application Title:	<input type="text"/>
BLF List URI:	<input type="text"/>

Softkeys

2. Select from "**Key 1**" through "**Key 20**".
3. In the "**Type**" field, select **Call Forward**.
4. In the state fields, check (enable) or uncheck (disable) the states you want to apply to this softkey.

Programmable Keys

5. Select from "**Key 1**" through "**Key 6**".
6. In the "**Type**" field, select **Call Forward**.

Expansion Module Keys

7. Select from "**Key 1**" through "**Key 36**" (M670i)
or
Select from "**Key 1**" through "**Key 60**" (M675i)
8. In the "**Type**" field, select **Call Forward**.
9. Click  to save your changes.

BLF/Xfer

The BLF key allows one or more extensions to be monitored, and once there is any state change with those extensions, the key shows the status of the monitored lines. The Xfer key allows a call to be transferred to other recipients blindly or consultatively. The BLF/Xfer key combines the BLF and Xfer key's functionality together allowing the user to transfer calls or use BLF with one key.



Note: It is recommended that you enable the “Switch UI Focus to Ringing Line” parameter when using the BLF/Xfer feature. For more information about this parameter, see [“Switch UI Focus to Ringing Line”](#) on page 223.

BLF/Xfer Key Requirements and Functionality

- **BLF/Xfer and BLF**

A BLF/Xfer key can be configured for subscribing to an extension and monitor the status of the extension, similar to the BLF key functionality. Changes of the state of the monitored extension are indicated by a LED / Icon.

- **BLF/Xfer and Blind Transfer Calls**

When the focused line is in the “Connected” state, pressing the BLF/Xfer key transfers the call to the extension unconditionally, disregarding the status of the monitored extension.

If transferring a call to an extension fails, a message “Transfer Failed” displays on the phone, and you can reconnect the call (get the call back) by pressing the line key again.

- **BLF/Xfer and Call Forward**

When the focused line is in the “Ringing” state, pressing the BLF/Xfer key forwards the call to the extension unconditionally, disregarding the status of the monitored extension.

- **BLF/Xfer and Speeddial**

When the focused line and the monitored extension are idle, pressing the BLF/Xfer key causes the phone to go offhook and dial the number of the extension.

Configuring a BLF/Xfer Key



Aastra Web UI

1. Click on **Operation->Softkeys and XML**.
or
Click on **Operation->Programmable Keys**.
or
Click on **Operation->Expansion Module <N>**.

Status		Softkeys Configuration									
System Information		Key	Type	Label	Value	Line	Idle	Connected	Incoming	Outgoing	Busy
Operation		1	WebApps			global	<input checked="" type="checkbox"/>	<input checked="" type="checkbox"/>	<input checked="" type="checkbox"/>	<input checked="" type="checkbox"/>	<input checked="" type="checkbox"/>
User Password		2	None			1	<input checked="" type="checkbox"/>	<input checked="" type="checkbox"/>	<input checked="" type="checkbox"/>	<input checked="" type="checkbox"/>	<input checked="" type="checkbox"/>
Phone Lock		3	None			1	<input checked="" type="checkbox"/>	<input checked="" type="checkbox"/>	<input checked="" type="checkbox"/>	<input checked="" type="checkbox"/>	<input checked="" type="checkbox"/>
Softkeys and XML		4	None			1	<input checked="" type="checkbox"/>	<input checked="" type="checkbox"/>	<input checked="" type="checkbox"/>	<input checked="" type="checkbox"/>	<input checked="" type="checkbox"/>
Programmable Keys		5	None			1	<input checked="" type="checkbox"/>	<input checked="" type="checkbox"/>	<input checked="" type="checkbox"/>	<input checked="" type="checkbox"/>	<input checked="" type="checkbox"/>
Keypad Speed Dial		6	None			1	<input checked="" type="checkbox"/>	<input checked="" type="checkbox"/>	<input checked="" type="checkbox"/>	<input checked="" type="checkbox"/>	<input checked="" type="checkbox"/>
Directory		7	None			1	<input checked="" type="checkbox"/>	<input checked="" type="checkbox"/>	<input checked="" type="checkbox"/>	<input checked="" type="checkbox"/>	<input checked="" type="checkbox"/>
Reset		8	None			1	<input checked="" type="checkbox"/>	<input checked="" type="checkbox"/>	<input checked="" type="checkbox"/>	<input checked="" type="checkbox"/>	<input checked="" type="checkbox"/>
Basic Settings		9	None			1	<input checked="" type="checkbox"/>	<input checked="" type="checkbox"/>	<input checked="" type="checkbox"/>	<input checked="" type="checkbox"/>	<input checked="" type="checkbox"/>
Preferences		10	None			1	<input checked="" type="checkbox"/>	<input checked="" type="checkbox"/>	<input checked="" type="checkbox"/>	<input checked="" type="checkbox"/>	<input checked="" type="checkbox"/>
Account Configuration		11	None			1	<input checked="" type="checkbox"/>	<input checked="" type="checkbox"/>	<input checked="" type="checkbox"/>	<input checked="" type="checkbox"/>	<input checked="" type="checkbox"/>
		12	None			1	<input checked="" type="checkbox"/>	<input checked="" type="checkbox"/>	<input checked="" type="checkbox"/>	<input checked="" type="checkbox"/>	<input checked="" type="checkbox"/>
		13	None			1	<input checked="" type="checkbox"/>	<input checked="" type="checkbox"/>	<input checked="" type="checkbox"/>	<input checked="" type="checkbox"/>	<input checked="" type="checkbox"/>
		14	None			1	<input checked="" type="checkbox"/>	<input checked="" type="checkbox"/>	<input checked="" type="checkbox"/>	<input checked="" type="checkbox"/>	<input checked="" type="checkbox"/>
		15	None			1	<input checked="" type="checkbox"/>	<input checked="" type="checkbox"/>	<input checked="" type="checkbox"/>	<input checked="" type="checkbox"/>	<input checked="" type="checkbox"/>
		16	None			1	<input checked="" type="checkbox"/>	<input checked="" type="checkbox"/>	<input checked="" type="checkbox"/>	<input checked="" type="checkbox"/>	<input checked="" type="checkbox"/>
		17	None			1	<input checked="" type="checkbox"/>	<input checked="" type="checkbox"/>	<input checked="" type="checkbox"/>	<input checked="" type="checkbox"/>	<input checked="" type="checkbox"/>
		18	None			1	<input checked="" type="checkbox"/>	<input checked="" type="checkbox"/>	<input checked="" type="checkbox"/>	<input checked="" type="checkbox"/>	<input checked="" type="checkbox"/>
		19	None			1	<input checked="" type="checkbox"/>	<input checked="" type="checkbox"/>	<input checked="" type="checkbox"/>	<input checked="" type="checkbox"/>	<input checked="" type="checkbox"/>
		20	None			1	<input checked="" type="checkbox"/>	<input checked="" type="checkbox"/>	<input checked="" type="checkbox"/>	<input checked="" type="checkbox"/>	<input checked="" type="checkbox"/>
		Services									
		XML Application URI:					<input type="text"/>				
		XML Application Title:					<input type="text"/>				
		BLF List URI:					<input type="text"/>				

Softkeys

2. Select from "Key 1" through "Key 20".
3. In the "Type" field, select **BLF/Xfer**.
4. In the "Label" field, enter a label for the BLF/Xfer key.
5. In the "Value" field, enter the monitored extension or the extension to transfer calls to (for example, "35").
6. In the "Line" field, select the line for which you want to use the key functionality.
Valid values are:
 - global
 - 1 through 9
7. In the state fields, check (enable) or uncheck (disable) the states you want to apply to this softkey.

Programmable Keys

8. Select from "**Key 1**" through "**Key 6**"
9. In the "**Type**" field, select **BLF/Xfer**.
10. In the "**Value**" field, enter the monitored extension or the extension to transfer calls to (for example, "**35**").
11. In the "**Line**" field, select the line for which you want to use the key functionality.
Valid values are:
 - global
 - **1** through **9**

Expansion Module Keys

12. Select from "**Key 1**" through "**Key 36**" (M670i)
or
Select from "**Key 1**" through "**Key 60**" (M675i)
13. In the "**Type**" field, select **BLF/Xfer**.
14. (M675i) In the "**Label**" field, enter a label for the BLF/Xfer key.
15. In the "**Value**" field, enter the monitored extension or the extension to transfer calls to (for example, "**35**").
16. In the "**Line**" field, select the line for which you want to use the key functionality.
Valid values are:
 - global
 - **1** through **9**
17. Click  to save your changes.

Speeddial/Xfer

The Speeddial key allows a number to be dialed quickly by pressing one key configured for speeddialing. The Xfer key allows a call to be transferred to other recipients blindly or consultatively. The Speeddial/Xfer key combines the Speeddial and Xfer key's functionality together allowing the user to transfer calls or use Speeddial with one key.



Note: It is recommended that you enable the “Switch UI Focus to Ringing Line” parameter when using the Speeddial/Xfer feature. For more information about this parameter, see [“Switch UI Focus to Ringing Line”](#) on page 223.

Speeddial/Xfer Key Requirements and Functionality

The Speeddial/Xfer key has the following capabilities:

- **Speeddial/Xfer and Speeddial**
When the phone is in the “Idle” state, pressing the Speeddial/Xfer key causes the phone to go offhook and dial the predefined extension.
- **Speeddial/Xfer and Blind Transfer**
When the phone is connected to a call, pressing the Speeddial/Xfer key blind transfers the call to the predefined target.

If transferring a call fails, a message “Transfer Failed” displays, and you can reconnect the call (get the call back) by pressing the line key again.
- **Speeddial/Xfer and Call Forward**
When the phone is in the “Ringing” state, pressing the Speeddial/Xfer key forwards the call to the predefined extension.

Configuring a Speeddial/Xfer Key



Aastra Web UI

1. Click on **Operation->Softkeys and XML**.
or
Click on **Operation->Programmable Keys**.
or
Click on **Operation->Expansion Module <N>**.

Key	Type	Label	Value	Line	Idle	Connected	Incoming	Outgoing	Busy
1	WebApps			global	<input checked="" type="checkbox"/>	<input checked="" type="checkbox"/>	<input checked="" type="checkbox"/>	<input checked="" type="checkbox"/>	<input checked="" type="checkbox"/>
2	None			1	<input checked="" type="checkbox"/>	<input checked="" type="checkbox"/>	<input checked="" type="checkbox"/>	<input checked="" type="checkbox"/>	<input checked="" type="checkbox"/>
3	None			1	<input checked="" type="checkbox"/>	<input checked="" type="checkbox"/>	<input checked="" type="checkbox"/>	<input checked="" type="checkbox"/>	<input checked="" type="checkbox"/>
4	None			1	<input checked="" type="checkbox"/>	<input checked="" type="checkbox"/>	<input checked="" type="checkbox"/>	<input checked="" type="checkbox"/>	<input checked="" type="checkbox"/>
5	None			1	<input checked="" type="checkbox"/>	<input checked="" type="checkbox"/>	<input checked="" type="checkbox"/>	<input checked="" type="checkbox"/>	<input checked="" type="checkbox"/>
6	None			1	<input checked="" type="checkbox"/>	<input checked="" type="checkbox"/>	<input checked="" type="checkbox"/>	<input checked="" type="checkbox"/>	<input checked="" type="checkbox"/>
7	None			1	<input checked="" type="checkbox"/>	<input checked="" type="checkbox"/>	<input checked="" type="checkbox"/>	<input checked="" type="checkbox"/>	<input checked="" type="checkbox"/>
8	None			1	<input checked="" type="checkbox"/>	<input checked="" type="checkbox"/>	<input checked="" type="checkbox"/>	<input checked="" type="checkbox"/>	<input checked="" type="checkbox"/>
9	None			1	<input checked="" type="checkbox"/>	<input checked="" type="checkbox"/>	<input checked="" type="checkbox"/>	<input checked="" type="checkbox"/>	<input checked="" type="checkbox"/>
10	None			1	<input checked="" type="checkbox"/>	<input checked="" type="checkbox"/>	<input checked="" type="checkbox"/>	<input checked="" type="checkbox"/>	<input checked="" type="checkbox"/>
11	None			1	<input checked="" type="checkbox"/>	<input checked="" type="checkbox"/>	<input checked="" type="checkbox"/>	<input checked="" type="checkbox"/>	<input checked="" type="checkbox"/>
12	None			1	<input checked="" type="checkbox"/>	<input checked="" type="checkbox"/>	<input checked="" type="checkbox"/>	<input checked="" type="checkbox"/>	<input checked="" type="checkbox"/>
13	None			1	<input checked="" type="checkbox"/>	<input checked="" type="checkbox"/>	<input checked="" type="checkbox"/>	<input checked="" type="checkbox"/>	<input checked="" type="checkbox"/>
14	None			1	<input checked="" type="checkbox"/>	<input checked="" type="checkbox"/>	<input checked="" type="checkbox"/>	<input checked="" type="checkbox"/>	<input checked="" type="checkbox"/>
15	None			1	<input checked="" type="checkbox"/>	<input checked="" type="checkbox"/>	<input checked="" type="checkbox"/>	<input checked="" type="checkbox"/>	<input checked="" type="checkbox"/>
16	None			1	<input checked="" type="checkbox"/>	<input checked="" type="checkbox"/>	<input checked="" type="checkbox"/>	<input checked="" type="checkbox"/>	<input checked="" type="checkbox"/>
17	None			1	<input checked="" type="checkbox"/>	<input checked="" type="checkbox"/>	<input checked="" type="checkbox"/>	<input checked="" type="checkbox"/>	<input checked="" type="checkbox"/>
18	None			1	<input checked="" type="checkbox"/>	<input checked="" type="checkbox"/>	<input checked="" type="checkbox"/>	<input checked="" type="checkbox"/>	<input checked="" type="checkbox"/>
19	None			1	<input checked="" type="checkbox"/>	<input checked="" type="checkbox"/>	<input checked="" type="checkbox"/>	<input checked="" type="checkbox"/>	<input checked="" type="checkbox"/>
20	None			1	<input checked="" type="checkbox"/>	<input checked="" type="checkbox"/>	<input checked="" type="checkbox"/>	<input checked="" type="checkbox"/>	<input checked="" type="checkbox"/>

Services	
XML Application URI:	<input type="text"/>
XML Application Title:	<input type="text"/>
BLF List URI:	<input type="text"/>

Softkeys

2. Select from "Key 1" through "Key 20".
3. In the "Type" field, select **Speeddial/Xfer**.
4. In the "Label" field, enter a label for the Speeddial/Xfer key.
5. In the "Value" field, enter the speeddial extension or the extension to transfer calls to (for example, "5551212").
6. In the "Line" field, select the line for which you want to use the key functionality.
Valid values are:
 - global
 - 1 through 9
7. In the state fields, check (enable) or uncheck (disable) the states you want to apply to this softkey.

Programmable Keys

8. Select from "Key 1" through "Key 6"
9. In the "Type" field, select **Speeddial/Xfer**.
10. In the "Value" field, enter the speeddial extension or the extension to transfer calls to (for example, "5551212").
11. In the "Line" field, select the line for which you want to use the key functionality.
Valid values are:
 - global
 - 1 through 9

Expansion Module Keys

12. Select from "Key 1" through "Key 36" (M670i)
or
Select from "Key 1" through "Key 60" (M675i)
13. In the "Type" field, select **Speeddial/Xfer**.
14. (M675i) In the "Label" field, enter a label for the Speeddial/Xfer key.
15. In the "Value" field, enter the speeddial extension or the extension to transfer calls to (for example, "5551212").
16. In the "Line" field, select the line for which you want to use the key functionality.
Valid values are:
 - global
 - 1 through 9
17. Click  to save your changes.

Speeddial/Conf

The 6755i allows you to configure a softkey or programmable key or expansion module key to be used as a speeddial conference key (**Speeddial/Conf** key) while remaining in the current call. This key allows a user on a call to conference another party at a pre-defined number while remaining in the call.

For example, while on an active call, a user can use the Speeddial/Conf key to dial a recording service and have the resulting conference recorded.



Note: If currently in a conference, the Speeddial/Conf key is disabled on the active call.

If you configure a softkey or programmable key or expansion module key as a **Speeddial/Conf** key and you press this key while on an active call, the focused line changes to the dialing line. A **Cancel** softkey displays on the phone allowing you to abort the conference speeddial if required. The message "*Ringin...*" displays below the number when the far end is ringing. The message "*Conf. Unavailable*" briefly displays when a conference is already in progress. The active call is not put on hold when the speeddial number is dialed.



Note: This feature is not compatible with centralized conferencing.

Configuring a Speeddial/Conf Key



Aastra Web UI

1. Click on **Operation->Softkeys and XML**.
or
Click on **Operation->Programmable Keys**.
or
Click on **Operation->Expansion Module <N>**.

Status		Softkeys Configuration									
System Information		Key	Type	Label	Value	Line	Idle	Connected	Incoming	Outgoing	Busy
Operation		1	WebApps			global	<input checked="" type="checkbox"/>	<input checked="" type="checkbox"/>	<input checked="" type="checkbox"/>	<input checked="" type="checkbox"/>	<input checked="" type="checkbox"/>
User Password		2	None			1	<input checked="" type="checkbox"/>	<input checked="" type="checkbox"/>	<input checked="" type="checkbox"/>	<input checked="" type="checkbox"/>	<input checked="" type="checkbox"/>
Phone Lock		3	None			1	<input checked="" type="checkbox"/>	<input checked="" type="checkbox"/>	<input checked="" type="checkbox"/>	<input checked="" type="checkbox"/>	<input checked="" type="checkbox"/>
Softkeys and XML		4	None			1	<input checked="" type="checkbox"/>	<input checked="" type="checkbox"/>	<input checked="" type="checkbox"/>	<input checked="" type="checkbox"/>	<input checked="" type="checkbox"/>
Programmable Keys		5	None			1	<input checked="" type="checkbox"/>	<input checked="" type="checkbox"/>	<input checked="" type="checkbox"/>	<input checked="" type="checkbox"/>	<input checked="" type="checkbox"/>
Keypad Speed Dial		6	None			1	<input checked="" type="checkbox"/>	<input checked="" type="checkbox"/>	<input checked="" type="checkbox"/>	<input checked="" type="checkbox"/>	<input checked="" type="checkbox"/>
Directory		7	None			1	<input checked="" type="checkbox"/>	<input checked="" type="checkbox"/>	<input checked="" type="checkbox"/>	<input checked="" type="checkbox"/>	<input checked="" type="checkbox"/>
Reset		8	None			1	<input checked="" type="checkbox"/>	<input checked="" type="checkbox"/>	<input checked="" type="checkbox"/>	<input checked="" type="checkbox"/>	<input checked="" type="checkbox"/>
Basic Settings		9	None			1	<input checked="" type="checkbox"/>	<input checked="" type="checkbox"/>	<input checked="" type="checkbox"/>	<input checked="" type="checkbox"/>	<input checked="" type="checkbox"/>
Preferences		10	None			1	<input checked="" type="checkbox"/>	<input checked="" type="checkbox"/>	<input checked="" type="checkbox"/>	<input checked="" type="checkbox"/>	<input checked="" type="checkbox"/>
Account Configuration		11	None			1	<input checked="" type="checkbox"/>	<input checked="" type="checkbox"/>	<input checked="" type="checkbox"/>	<input checked="" type="checkbox"/>	<input checked="" type="checkbox"/>
		12	None			1	<input checked="" type="checkbox"/>	<input checked="" type="checkbox"/>	<input checked="" type="checkbox"/>	<input checked="" type="checkbox"/>	<input checked="" type="checkbox"/>
		13	None			1	<input checked="" type="checkbox"/>	<input checked="" type="checkbox"/>	<input checked="" type="checkbox"/>	<input checked="" type="checkbox"/>	<input checked="" type="checkbox"/>
		14	None			1	<input checked="" type="checkbox"/>	<input checked="" type="checkbox"/>	<input checked="" type="checkbox"/>	<input checked="" type="checkbox"/>	<input checked="" type="checkbox"/>
		15	None			1	<input checked="" type="checkbox"/>	<input checked="" type="checkbox"/>	<input checked="" type="checkbox"/>	<input checked="" type="checkbox"/>	<input checked="" type="checkbox"/>
		16	None			1	<input checked="" type="checkbox"/>	<input checked="" type="checkbox"/>	<input checked="" type="checkbox"/>	<input checked="" type="checkbox"/>	<input checked="" type="checkbox"/>
		17	None			1	<input checked="" type="checkbox"/>	<input checked="" type="checkbox"/>	<input checked="" type="checkbox"/>	<input checked="" type="checkbox"/>	<input checked="" type="checkbox"/>
		18	None			1	<input checked="" type="checkbox"/>	<input checked="" type="checkbox"/>	<input checked="" type="checkbox"/>	<input checked="" type="checkbox"/>	<input checked="" type="checkbox"/>
		19	None			1	<input checked="" type="checkbox"/>	<input checked="" type="checkbox"/>	<input checked="" type="checkbox"/>	<input checked="" type="checkbox"/>	<input checked="" type="checkbox"/>
		20	None			1	<input checked="" type="checkbox"/>	<input checked="" type="checkbox"/>	<input checked="" type="checkbox"/>	<input checked="" type="checkbox"/>	<input checked="" type="checkbox"/>
		Services									
		XML Application URI:					<input type="text"/>				
		XML Application Title:					<input type="text"/>				
		BLF List URI:					<input type="text"/>				

Softkeys

2. Select from "Key 1" through "Key 20".
3. In the "Type" field, select **Speeddial/Conf**.
4. In the "Label" field, enter a label for the Speeddial/Conf key.
5. In the "Value" field, enter the speeddial extension or the extension to add to the conference (for example, "5551212").
6. In the "Line" field, select the line for which you want to use the key functionality.
Valid values are:
 - global
 - 1 through 9
7. In the state fields, check (enable) or uncheck (disable) the states you want to apply to this softkey.

Programmable Keys

8. Select from "**Key 1**" through "**Key 6**"
9. In the "**Type**" field, select **Speeddial/Conf**.
10. In the "**Value**" field, enter the speeddial extension or the extension to add to the conference (for example, "**5551212**").
11. In the "**Line**" field, select the line for which you want to use the key functionality.
Valid values are:
 - global
 - **1** through **9**

Expansion Module Keys

12. Select from "**Key 1**" through "**Key 36**" (M670i)
or
Select from "**Key 1**" through "**Key 60**" (M675i)
13. In the "**Type**" field, select **Speeddial/Conf**.
14. (M675i) In the "**Label**" field, enter a label for the Speeddial/Conf key.
15. In the "**Value**" field, enter the speeddial extension or the extension to add to the conference (for example, "**5551212**").
16. In the "**Line**" field, select the line for which you want to use the key functionality.
Valid values are:
 - global
 - **1** through **9**
17. Click  to save your changes.

Services Key

By default, the 6755i has a Services key configured on key 1 of the top set of keys. However, you can use any key to configure a "Services" key.

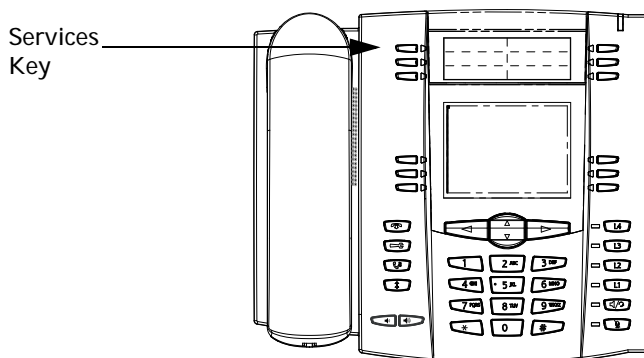

The Services key accesses enhanced features and services provided by third parties. Using the "Services" key, you can:

- Select customized (XML) features
- Utilize a Caller List
- Utilize a Directory
- Utilize Voicemail



Note: Other than the Services Menu, you can also configure the Caller List and Directory List on separate keys.

The XML customized services are created and provided by your System Administrator through the diverse web based language of XML. Availability of these services depends on your phone system or service provider.

Reference

For more information about XML, Caller List, Directory, and Voicemail, see the following:

- [“XML Key” on page 101](#)
- [“Callers List” on page 183](#)
- [“Directory List” on page 172](#)
- [“Voicemail” on page 210](#)



Note: Your System Administrator can create a custom Services key for your application. For more information about custom Services, see [“Customizable Callers List Key and Services Key” on page 242](#).

Configuring a Services Key



Aastra Web UI

Use the following procedure to configure a Services key on the 6755i IP Phone. The procedure shows the programmable key screen as an example.



Note: By default, the **Services** key is Key 1 on the programmable keys.

1. Click on **Operation->Softkeys and XML**.
or
Click on **Operation->Programmable Keys**.
or
Click on **Operation->Expansion Module <N>**.

Key	Type	Value	Line
1	Services		global
2	Directory		1
3	Callers List		1
4	Intercom		global
5	None		1
6	None		1

Services

XML Application URI:

XML Application Title:

BLF List URI:

Softkeys

2. Select from "**Key 1**" through "**Key 20**".
3. In the "**Type**" field, select **Services**.
4. In the "**Label**" field, enter a label to apply to this key.
5. In the state fields, check (enable) or uncheck (disable) the states you want to apply to this softkey.

Programmable Keys

6. Select from "**Key 1**" through "**Key 6**".
7. In the "**Type**" field, select **Services**.

Expansion Module Keys

8. Select from “**Key 1**” through “**Key 36**” (M670i)
or
Select from “**Key 1**” through “**Key 60**” (M675i)
9. In the "**Type**" field, select **Services**.
10. (M675i) In the "**Label**" field, enter a label to apply to this key.
11. Click  to save your changes.

Directory Key

By default, the 6755i has a Directory key configured on key 2 of the top set of keys. However, using the Aastra Web UI, you can assign the Directory key to any key on the top or bottom keys on the phone.

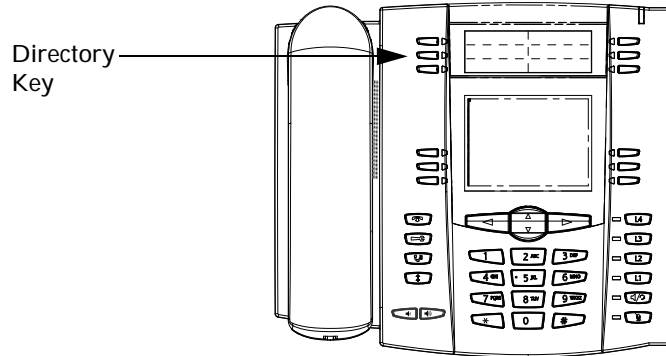

The "Directory List" feature allows you to store frequently used names and numbers on the phone. You can also dial directly from a directory entry.

You can use the Directory key to access a Directory List which contains a customized list of names with phone numbers and labels.

In addition to creating a Directory key, you can also download a Directory List to your PC if required using the Aastra Web UI.

Reference

For more information about the Directory List, see ["Directory List"](#) on page 172.

Configuring a Directory Key



Aastra Web UI

Use the following procedure to configure a Directory key on the 6755i IP Phone. The procedure shows the programmable key screen as an example.



Note: By default, the **Directory** key is Key 2 on the programmable keys..

1. Click on **Operation->Softkeys and XML**.
- or
- Click on **Operation->Programmable Keys**.
- or
- Click on **Operation->Expansion Module <N>**.

<p>Status</p> <ul style="list-style-type: none"> System Information Operation <ul style="list-style-type: none"> User Password Phone Lock Softkeys and XML Programmable Keys Keypad Speed Dial Directory Reset Basic Settings <ul style="list-style-type: none"> Preferences Account Configuration 	<p>Programmable Keys Configuration</p> <table border="1" style="width: 100%; border-collapse: collapse;"> <thead> <tr style="background-color: #e6f2ff;"> <th>Key</th> <th>Type</th> <th>Value</th> <th>Line</th> </tr> </thead> <tbody> <tr> <td>1</td> <td>Services</td> <td></td> <td>global</td> </tr> <tr> <td>2</td> <td>Directory</td> <td></td> <td>1</td> </tr> <tr> <td>3</td> <td>Callers List</td> <td></td> <td>1</td> </tr> <tr> <td>4</td> <td>Intercom</td> <td></td> <td>global</td> </tr> <tr> <td>5</td> <td>None</td> <td></td> <td>1</td> </tr> <tr> <td>6</td> <td>None</td> <td></td> <td>1</td> </tr> </tbody> </table> <p>Services</p> <p>XML Application URI: <input type="text"/></p> <p>XML Application Title: <input type="text"/></p> <p>BLF List URI: <input type="text"/></p> <p style="text-align: center;"><input type="button" value="Save Settings"/></p>	Key	Type	Value	Line	1	Services		global	2	Directory		1	3	Callers List		1	4	Intercom		global	5	None		1	6	None		1
Key	Type	Value	Line																										
1	Services		global																										
2	Directory		1																										
3	Callers List		1																										
4	Intercom		global																										
5	None		1																										
6	None		1																										

Softkeys

2. Select from "**Key 1**" through "**Key 20**".
3. In the "**Type**" field, select **Directory**.
4. In the "**Label**" field, enter a label to apply to this key.
5. In the state fields, check (enable) or uncheck (disable) the states you want to apply to this softkey.

Programmable Keys

6. Select from "**Key 1**" through "**Key 6**".
7. In the "**Type**" field, select **Directory**.

Expansion Module Keys

8. Select from "**Key 1**" through "**Key 36**" (M670i)
or
Select from "**Key 1**" through "**Key 60**" (M675i)
9. In the "**Type**" field, select **Directory**.
10. (M675i) In the "**Label**" field, enter a label to apply to this key.
11. Click to save your changes.

Callers List Key

By default, the 6755i has a Callers List key configured on key 3 of the top set of keys. However, using the Aastra Web UI, you can assign the Callers List key to any key on the top or bottom keys on the phone.

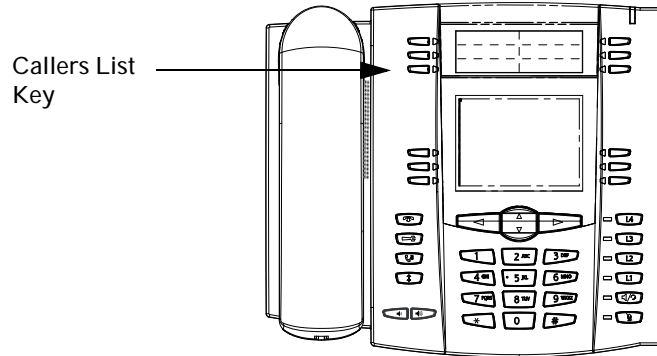

The Callers list is a stored log of your incoming calls. You can use the Callers List key to access a list of callers that called your phone.



Note: Your System Administrator can create a custom Callers List XML application allowing you to access the Callers List via an XML Key instead of the Callers List Key. This allows you to configure the Callers List Key with other functions if required. Contact your System Administrator for more information.

Reference

For more information about the Callers List, see [“Callers List”](#) on page 183.

Configuring a Callers List Key



Aastra Web UI

Use the following procedure to configure a Callers List key on the 6755i IP Phone. The procedure shows the programmable key screen as an example.



Note: By default, the **Callers List** key is Key 3 on the programmable keys..

1. Click on **Operation->Softkeys and XML**.
- or
- Click on **Operation->Programmable Keys**.
- or
- Click on **Operation->Expansion Module <N>**.

<p>Status</p> <ul style="list-style-type: none"> System Information <p>Operation</p> <ul style="list-style-type: none"> User Password Phone Lock Softkeys and XML Programmable Keys Keypad Speed Dial Directory Reset <p>Basic Settings</p> <ul style="list-style-type: none"> Preferences Account Configuration 	<p>Programmable Keys Configuration</p> <table border="1" style="width: 100%; border-collapse: collapse;"> <thead> <tr style="background-color: #e6f2ff;"> <th>Key</th> <th>Type</th> <th>Value</th> <th>Line</th> </tr> </thead> <tbody> <tr> <td>1</td> <td>Services</td> <td></td> <td>global</td> </tr> <tr> <td>2</td> <td>Directory</td> <td></td> <td>1</td> </tr> <tr> <td>3</td> <td>Callers List</td> <td></td> <td>1</td> </tr> <tr> <td>4</td> <td>Intercom</td> <td></td> <td>global</td> </tr> <tr> <td>5</td> <td>None</td> <td></td> <td>1</td> </tr> <tr> <td>6</td> <td>None</td> <td></td> <td>1</td> </tr> </tbody> </table> <p>Services</p> <p>XML Application URI: <input type="text"/></p> <p>XML Application Title: <input type="text"/></p> <p>BLF List URI: <input type="text"/></p> <p style="text-align: center;"><input type="button" value="Save Settings"/></p>	Key	Type	Value	Line	1	Services		global	2	Directory		1	3	Callers List		1	4	Intercom		global	5	None		1	6	None		1
Key	Type	Value	Line																										
1	Services		global																										
2	Directory		1																										
3	Callers List		1																										
4	Intercom		global																										
5	None		1																										
6	None		1																										

Softkeys

2. Select from "**Key 1**" through "**Key 20**".
3. In the "**Type**" field, select **Callers List**.
4. In the "**Label**" field, enter a label to apply to this key.
5. In the state fields, check (enable) or uncheck (disable) the states you want to apply to this softkey.

Programmable Keys

6. Select from "**Key 1**" through "**Key 6**".
7. In the "**Type**" field, select **Callers List**.

Expansion Module Keys

8. Select from "**Key 1**" through "**Key 36**" (M670i)
or
Select from "**Key 1**" through "**Key 60**" (M675i)
9. In the "**Type**" field, select **Callers List**.
10. (M675i) In the "**Label**" field, enter a label to apply to this key.
11. Click to save your changes.

Intercom Key

By default, the 6755i has an Intercom key configured on key 4 of the top set of keys. However, using the Aastra Web UI, you can assign the Intercom key to any key on the top or bottom keys on the phone.

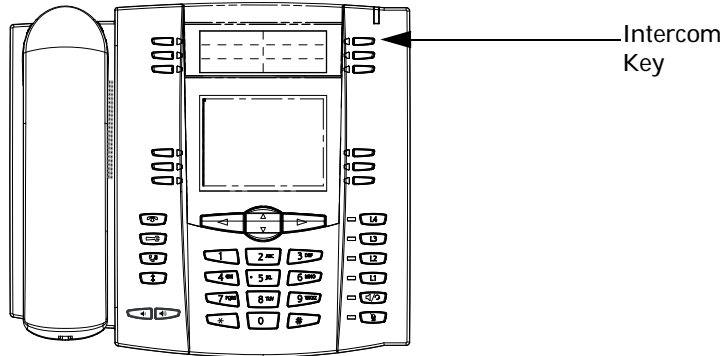

You can use the Intercom key to automatically connect with a remote extension for outgoing calls, and to answer an incoming intercom call.

Reference

For more information about the Intercom key, see [“Using Intercom”](#) on page 155.

Configuring an Intercom Key



Aastra Web UI

Use the following procedure to configure a Callers List key on the 6755i IP Phone. The procedure shows the programmable key screen as an example.



Note: By default, the **Intercom** key is Key 4 on the programmable keys.

1. Click on **Operation->Softkeys and XML**.
- or
- Click on **Operation->Programmable Keys**.
- or
- Click on **Operation->Expansion Module <N>**.

<p>Status</p> <ul style="list-style-type: none"> System Information Operation <ul style="list-style-type: none"> User Password Phone Lock Softkeys and XML Programmable Keys Keypad Speed Dial Directory Reset Basic Settings <ul style="list-style-type: none"> Preferences Account Configuration 	<p>Programmable Keys Configuration</p> <table border="1" style="width: 100%; border-collapse: collapse;"> <thead> <tr style="background-color: #e6f2ff;"> <th>Key</th> <th>Type</th> <th>Value</th> <th>Line</th> </tr> </thead> <tbody> <tr> <td>1</td> <td>Services</td> <td></td> <td>global</td> </tr> <tr> <td>2</td> <td>Directory</td> <td></td> <td>1</td> </tr> <tr> <td>3</td> <td>Callers List</td> <td></td> <td>1</td> </tr> <tr> <td>4</td> <td>Intercom</td> <td></td> <td>global</td> </tr> <tr> <td>5</td> <td>None</td> <td></td> <td>1</td> </tr> <tr> <td>6</td> <td>None</td> <td></td> <td>1</td> </tr> </tbody> </table> <p>Services</p> <p>XML Application URI: <input type="text"/></p> <p>XML Application Title: <input type="text"/></p> <p>BLF List URI: <input type="text"/></p> <p style="text-align: center;"><input type="button" value="Save Settings"/></p>	Key	Type	Value	Line	1	Services		global	2	Directory		1	3	Callers List		1	4	Intercom		global	5	None		1	6	None		1
Key	Type	Value	Line																										
1	Services		global																										
2	Directory		1																										
3	Callers List		1																										
4	Intercom		global																										
5	None		1																										
6	None		1																										

Softkeys

2. Select from "**Key 1**" through "**Key 20**".
3. In the "**Type**" field, select **Intercom**.
4. In the "**Label**" field, enter a label to apply to this key.
5. In the state fields, check (enable) or uncheck (disable) the states you want to apply to this softkey.

Programmable Keys

6. Select from "**Key 1**" through "**Key 6**".
7. In the "**Type**" field, select **Intercom**.

Expansion Module Keys

8. Select from "**Key 1**" through "**Key 36**" (M670i)
or
Select from "**Key 1**" through "**Key 60**" (M675i)
9. In the "**Type**" field, select **Intercom**.
10. (M675i) In the "**Label**" field, enter a label to apply to this key.
11. Click to save your changes.

Phone Lock Key

You can configure a key on the IP Phone to use as a lock/unlock key. You assign the function of the key as “**Phone Lock**”.

Configuring a Phone Lock Key

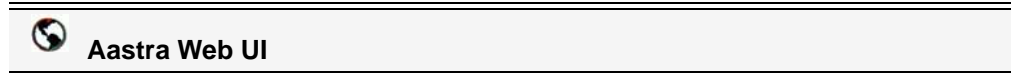

Use the following procedure to configure a Phone Lock key on the 6755i IP Phone. The procedure shows the softkey screen as an example.

1. Click on **Operation->Softkeys and XML**.
or
Click on **Operation->Programmable Keys**.
or
Click on **Operation->Expansion Module <N>**.

Status		Softkeys Configuration									
System Information		Key	Type	Label	Value	Line	Idle	Connected	Incoming	Outgoing	Busy
Operation		1	WebApps			global	<input checked="" type="checkbox"/>	<input checked="" type="checkbox"/>	<input checked="" type="checkbox"/>	<input checked="" type="checkbox"/>	<input checked="" type="checkbox"/>
User Password		2	None			1	<input checked="" type="checkbox"/>	<input checked="" type="checkbox"/>	<input checked="" type="checkbox"/>	<input checked="" type="checkbox"/>	<input checked="" type="checkbox"/>
Phone Lock		3	None			1	<input checked="" type="checkbox"/>	<input checked="" type="checkbox"/>	<input checked="" type="checkbox"/>	<input checked="" type="checkbox"/>	<input checked="" type="checkbox"/>
Softkeys and XML		4	None			1	<input checked="" type="checkbox"/>	<input checked="" type="checkbox"/>	<input checked="" type="checkbox"/>	<input checked="" type="checkbox"/>	<input checked="" type="checkbox"/>
Programmable Keys		5	None			1	<input checked="" type="checkbox"/>	<input checked="" type="checkbox"/>	<input checked="" type="checkbox"/>	<input checked="" type="checkbox"/>	<input checked="" type="checkbox"/>
Keypad Speed Dial		6	None			1	<input checked="" type="checkbox"/>	<input checked="" type="checkbox"/>	<input checked="" type="checkbox"/>	<input checked="" type="checkbox"/>	<input checked="" type="checkbox"/>
Directory		7	None			1	<input checked="" type="checkbox"/>	<input checked="" type="checkbox"/>	<input checked="" type="checkbox"/>	<input checked="" type="checkbox"/>	<input checked="" type="checkbox"/>
Reset		8	None			1	<input checked="" type="checkbox"/>	<input checked="" type="checkbox"/>	<input checked="" type="checkbox"/>	<input checked="" type="checkbox"/>	<input checked="" type="checkbox"/>
Basic Settings		9	None			1	<input checked="" type="checkbox"/>	<input checked="" type="checkbox"/>	<input checked="" type="checkbox"/>	<input checked="" type="checkbox"/>	<input checked="" type="checkbox"/>
Preferences		10	None			1	<input checked="" type="checkbox"/>	<input checked="" type="checkbox"/>	<input checked="" type="checkbox"/>	<input checked="" type="checkbox"/>	<input checked="" type="checkbox"/>
Account Configuration		11	None			1	<input checked="" type="checkbox"/>	<input checked="" type="checkbox"/>	<input checked="" type="checkbox"/>	<input checked="" type="checkbox"/>	<input checked="" type="checkbox"/>
		12	None			1	<input checked="" type="checkbox"/>	<input checked="" type="checkbox"/>	<input checked="" type="checkbox"/>	<input checked="" type="checkbox"/>	<input checked="" type="checkbox"/>
		13	None			1	<input checked="" type="checkbox"/>	<input checked="" type="checkbox"/>	<input checked="" type="checkbox"/>	<input checked="" type="checkbox"/>	<input checked="" type="checkbox"/>
		14	None			1	<input checked="" type="checkbox"/>	<input checked="" type="checkbox"/>	<input checked="" type="checkbox"/>	<input checked="" type="checkbox"/>	<input checked="" type="checkbox"/>
		15	None			1	<input checked="" type="checkbox"/>	<input checked="" type="checkbox"/>	<input checked="" type="checkbox"/>	<input checked="" type="checkbox"/>	<input checked="" type="checkbox"/>
		16	None			1	<input checked="" type="checkbox"/>	<input checked="" type="checkbox"/>	<input checked="" type="checkbox"/>	<input checked="" type="checkbox"/>	<input checked="" type="checkbox"/>
		17	None			1	<input checked="" type="checkbox"/>	<input checked="" type="checkbox"/>	<input checked="" type="checkbox"/>	<input checked="" type="checkbox"/>	<input checked="" type="checkbox"/>
		18	None			1	<input checked="" type="checkbox"/>	<input checked="" type="checkbox"/>	<input checked="" type="checkbox"/>	<input checked="" type="checkbox"/>	<input checked="" type="checkbox"/>
		19	None			1	<input checked="" type="checkbox"/>	<input checked="" type="checkbox"/>	<input checked="" type="checkbox"/>	<input checked="" type="checkbox"/>	<input checked="" type="checkbox"/>
		20	None			1	<input checked="" type="checkbox"/>	<input checked="" type="checkbox"/>	<input checked="" type="checkbox"/>	<input checked="" type="checkbox"/>	<input checked="" type="checkbox"/>
		Services XML Application URI: <input type="text"/> XML Application Title: <input type="text"/> BLF List URI: <input type="text"/>									

Softkeys

2. Select from "Key 1" through "Key 20".
3. In the "Type" field, select **Phone Lock** from the list of options.

Programmable Keys

4. Select from "Key 1" through "Key 6"
5. In the "Type" field, select **Phone Lock** from the list of options.

Expansion Module Keys

6. Select from "Key 1" through "Key 36" (M670i)
or
Select from "Key 1" through "Key 60" (M675i)
7. In the "Type" field, select **Phone Lock** from the list of options.
8. Click  to save your changes.



Note: You can lock/unlock the phone using the new key you just configured, using the Aastra Web UI at the path *Operation->PhoneLock*, or using the "Phone Lock" option on the IP Phone UI at the path *Options->Phone Lock*. For more information about using the lock/unlock feature, see "[Locking/Unlocking a Phone](#)" on [page 56](#).

Using the Lock/Unlock Key on the IP Phone

After configuring a key as a lock/unlock key, refer to the following procedure to use the key on the IP phone.

Lock the Phone

1. Press the **LOCK** key.
The phone locks.
The LED for the key AND the Message Waiting Lamp illuminate steady ON. An "Unlock" label appears next to the key you just pressed.

Unlock the Phone

1. Press the **UNLOCK** key.
A password prompt displays.
2. Enter your user password and press **ENTER**.
The phone unlocks.
The LED for the key AND the Message Waiting Lamp go OFF. The "Lock" label appears next to the key you just pressed.

Paging Key (Sends the RTP Stream)

You can configure a Paging key on the phone that allows you to send a Real Time Transport Protocol (RTP) stream to pre-configured multicast address(es) without involving SIP signaling. You enter a multicast IP address(es) and a port number for the Paging key, that when pressed, initiates an outgoing multicast RTP session. This is called Group Paging on the IP phones.

You can also specify group paging RTP addresses that the phone listens for when receiving RTP streams. You can specify up to 5 listening multicast addresses at the path, *Basic Settings->Preferences->Group Paging RTP Settings*.

For more information about Group Paging and how it works, and to specify multicast addresses, see “[Group RTP Paging \(receives RTP streams\)](#)” on page 235.

Configuring a Paging Key

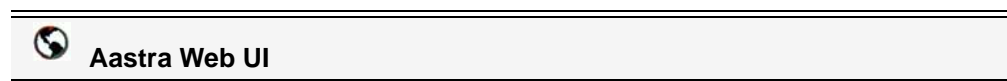

1. Click on **Operation->Softkeys and XML**.
or
Click on **Operation->Programmable Keys**.
or
Click on **Operation->Expansion Module <N>**.

Status System Information Operation User Password Phone Lock Softkeys and XML Programmable Keys Keypad Speed Dial Directory Reset Basic Settings Preferences Account Configuration	<h4>Softkeys Configuration</h4> <table border="1"> <thead> <tr> <th>Key</th> <th>Type</th> <th>Label</th> <th>Value</th> <th>Line</th> <th>Idle</th> <th>Connected</th> <th>Incoming</th> <th>Outgoing</th> <th>Busy</th> </tr> </thead> <tbody> <tr><td>1</td><td>WebApps</td><td></td><td></td><td>global</td><td><input checked="" type="checkbox"/></td><td><input checked="" type="checkbox"/></td><td><input checked="" type="checkbox"/></td><td><input checked="" type="checkbox"/></td><td><input checked="" type="checkbox"/></td></tr> <tr><td>2</td><td>None</td><td></td><td></td><td>1</td><td><input checked="" type="checkbox"/></td><td><input checked="" type="checkbox"/></td><td><input checked="" type="checkbox"/></td><td><input checked="" type="checkbox"/></td><td><input checked="" type="checkbox"/></td></tr> <tr><td>3</td><td>None</td><td></td><td></td><td>1</td><td><input checked="" type="checkbox"/></td><td><input checked="" type="checkbox"/></td><td><input checked="" type="checkbox"/></td><td><input checked="" type="checkbox"/></td><td><input checked="" type="checkbox"/></td></tr> <tr><td>4</td><td>None</td><td></td><td></td><td>1</td><td><input checked="" type="checkbox"/></td><td><input checked="" type="checkbox"/></td><td><input checked="" type="checkbox"/></td><td><input checked="" type="checkbox"/></td><td><input checked="" type="checkbox"/></td></tr> <tr><td>5</td><td>None</td><td></td><td></td><td>1</td><td><input checked="" type="checkbox"/></td><td><input checked="" type="checkbox"/></td><td><input checked="" type="checkbox"/></td><td><input checked="" type="checkbox"/></td><td><input checked="" type="checkbox"/></td></tr> <tr><td>6</td><td>None</td><td></td><td></td><td>1</td><td><input checked="" type="checkbox"/></td><td><input checked="" type="checkbox"/></td><td><input checked="" type="checkbox"/></td><td><input checked="" type="checkbox"/></td><td><input checked="" type="checkbox"/></td></tr> <tr><td>7</td><td>None</td><td></td><td></td><td>1</td><td><input checked="" type="checkbox"/></td><td><input checked="" type="checkbox"/></td><td><input checked="" type="checkbox"/></td><td><input checked="" type="checkbox"/></td><td><input checked="" type="checkbox"/></td></tr> <tr><td>8</td><td>None</td><td></td><td></td><td>1</td><td><input checked="" type="checkbox"/></td><td><input checked="" type="checkbox"/></td><td><input checked="" type="checkbox"/></td><td><input checked="" type="checkbox"/></td><td><input checked="" type="checkbox"/></td></tr> <tr><td>9</td><td>None</td><td></td><td></td><td>1</td><td><input checked="" type="checkbox"/></td><td><input checked="" type="checkbox"/></td><td><input checked="" type="checkbox"/></td><td><input checked="" type="checkbox"/></td><td><input checked="" type="checkbox"/></td></tr> <tr><td>10</td><td>None</td><td></td><td></td><td>1</td><td><input checked="" type="checkbox"/></td><td><input checked="" type="checkbox"/></td><td><input checked="" type="checkbox"/></td><td><input checked="" type="checkbox"/></td><td><input checked="" type="checkbox"/></td></tr> <tr><td>11</td><td>None</td><td></td><td></td><td>1</td><td><input checked="" type="checkbox"/></td><td><input checked="" type="checkbox"/></td><td><input checked="" type="checkbox"/></td><td><input checked="" type="checkbox"/></td><td><input checked="" type="checkbox"/></td></tr> <tr><td>12</td><td>None</td><td></td><td></td><td>1</td><td><input checked="" type="checkbox"/></td><td><input checked="" type="checkbox"/></td><td><input checked="" type="checkbox"/></td><td><input checked="" type="checkbox"/></td><td><input checked="" type="checkbox"/></td></tr> <tr><td>13</td><td>None</td><td></td><td></td><td>1</td><td><input checked="" type="checkbox"/></td><td><input checked="" type="checkbox"/></td><td><input checked="" type="checkbox"/></td><td><input checked="" type="checkbox"/></td><td><input checked="" type="checkbox"/></td></tr> <tr><td>14</td><td>None</td><td></td><td></td><td>1</td><td><input checked="" type="checkbox"/></td><td><input checked="" type="checkbox"/></td><td><input checked="" type="checkbox"/></td><td><input checked="" type="checkbox"/></td><td><input checked="" type="checkbox"/></td></tr> <tr><td>15</td><td>None</td><td></td><td></td><td>1</td><td><input checked="" type="checkbox"/></td><td><input checked="" type="checkbox"/></td><td><input checked="" type="checkbox"/></td><td><input checked="" type="checkbox"/></td><td><input checked="" type="checkbox"/></td></tr> <tr><td>16</td><td>None</td><td></td><td></td><td>1</td><td><input checked="" type="checkbox"/></td><td><input checked="" type="checkbox"/></td><td><input checked="" type="checkbox"/></td><td><input checked="" type="checkbox"/></td><td><input checked="" type="checkbox"/></td></tr> <tr><td>17</td><td>None</td><td></td><td></td><td>1</td><td><input checked="" type="checkbox"/></td><td><input checked="" type="checkbox"/></td><td><input checked="" type="checkbox"/></td><td><input checked="" type="checkbox"/></td><td><input checked="" type="checkbox"/></td></tr> <tr><td>18</td><td>None</td><td></td><td></td><td>1</td><td><input checked="" type="checkbox"/></td><td><input checked="" type="checkbox"/></td><td><input checked="" type="checkbox"/></td><td><input checked="" type="checkbox"/></td><td><input checked="" type="checkbox"/></td></tr> <tr><td>19</td><td>None</td><td></td><td></td><td>1</td><td><input checked="" type="checkbox"/></td><td><input checked="" type="checkbox"/></td><td><input checked="" type="checkbox"/></td><td><input checked="" type="checkbox"/></td><td><input checked="" type="checkbox"/></td></tr> <tr><td>20</td><td>None</td><td></td><td></td><td>1</td><td><input checked="" type="checkbox"/></td><td><input checked="" type="checkbox"/></td><td><input checked="" type="checkbox"/></td><td><input checked="" type="checkbox"/></td><td><input checked="" type="checkbox"/></td></tr> </tbody> </table> Services XML Application URI: <input type="text"/> XML Application Title: <input type="text"/> BLF List URI: <input type="text"/>	Key	Type	Label	Value	Line	Idle	Connected	Incoming	Outgoing	Busy	1	WebApps			global	<input checked="" type="checkbox"/>	<input checked="" type="checkbox"/>	<input checked="" type="checkbox"/>	<input checked="" type="checkbox"/>	<input checked="" type="checkbox"/>	2	None			1	<input checked="" type="checkbox"/>	<input checked="" type="checkbox"/>	<input checked="" type="checkbox"/>	<input checked="" type="checkbox"/>	<input checked="" type="checkbox"/>	3	None			1	<input checked="" type="checkbox"/>	<input checked="" type="checkbox"/>	<input checked="" type="checkbox"/>	<input checked="" type="checkbox"/>	<input checked="" type="checkbox"/>	4	None			1	<input checked="" type="checkbox"/>	<input checked="" type="checkbox"/>	<input checked="" type="checkbox"/>	<input checked="" type="checkbox"/>	<input checked="" type="checkbox"/>	5	None			1	<input checked="" type="checkbox"/>	<input checked="" type="checkbox"/>	<input checked="" type="checkbox"/>	<input checked="" type="checkbox"/>	<input checked="" type="checkbox"/>	6	None			1	<input checked="" type="checkbox"/>	<input checked="" type="checkbox"/>	<input checked="" type="checkbox"/>	<input checked="" type="checkbox"/>	<input checked="" type="checkbox"/>	7	None			1	<input checked="" type="checkbox"/>	<input checked="" type="checkbox"/>	<input checked="" type="checkbox"/>	<input checked="" type="checkbox"/>	<input checked="" type="checkbox"/>	8	None			1	<input checked="" type="checkbox"/>	<input checked="" type="checkbox"/>	<input checked="" type="checkbox"/>	<input checked="" type="checkbox"/>	<input checked="" type="checkbox"/>	9	None			1	<input checked="" type="checkbox"/>	<input checked="" type="checkbox"/>	<input checked="" type="checkbox"/>	<input checked="" type="checkbox"/>	<input checked="" type="checkbox"/>	10	None			1	<input checked="" type="checkbox"/>	<input checked="" type="checkbox"/>	<input checked="" type="checkbox"/>	<input checked="" type="checkbox"/>	<input checked="" type="checkbox"/>	11	None			1	<input checked="" type="checkbox"/>	<input checked="" type="checkbox"/>	<input checked="" type="checkbox"/>	<input checked="" type="checkbox"/>	<input checked="" type="checkbox"/>	12	None			1	<input checked="" type="checkbox"/>	<input checked="" type="checkbox"/>	<input checked="" type="checkbox"/>	<input checked="" type="checkbox"/>	<input checked="" type="checkbox"/>	13	None			1	<input checked="" type="checkbox"/>	<input checked="" type="checkbox"/>	<input checked="" type="checkbox"/>	<input checked="" type="checkbox"/>	<input checked="" type="checkbox"/>	14	None			1	<input checked="" type="checkbox"/>	<input checked="" type="checkbox"/>	<input checked="" type="checkbox"/>	<input checked="" type="checkbox"/>	<input checked="" type="checkbox"/>	15	None			1	<input checked="" type="checkbox"/>	<input checked="" type="checkbox"/>	<input checked="" type="checkbox"/>	<input checked="" type="checkbox"/>	<input checked="" type="checkbox"/>	16	None			1	<input checked="" type="checkbox"/>	<input checked="" type="checkbox"/>	<input checked="" type="checkbox"/>	<input checked="" type="checkbox"/>	<input checked="" type="checkbox"/>	17	None			1	<input checked="" type="checkbox"/>	<input checked="" type="checkbox"/>	<input checked="" type="checkbox"/>	<input checked="" type="checkbox"/>	<input checked="" type="checkbox"/>	18	None			1	<input checked="" type="checkbox"/>	<input checked="" type="checkbox"/>	<input checked="" type="checkbox"/>	<input checked="" type="checkbox"/>	<input checked="" type="checkbox"/>	19	None			1	<input checked="" type="checkbox"/>	<input checked="" type="checkbox"/>	<input checked="" type="checkbox"/>	<input checked="" type="checkbox"/>	<input checked="" type="checkbox"/>	20	None			1	<input checked="" type="checkbox"/>	<input checked="" type="checkbox"/>	<input checked="" type="checkbox"/>	<input checked="" type="checkbox"/>	<input checked="" type="checkbox"/>
Key	Type	Label	Value	Line	Idle	Connected	Incoming	Outgoing	Busy																																																																																																																																																																																																										
1	WebApps			global	<input checked="" type="checkbox"/>	<input checked="" type="checkbox"/>	<input checked="" type="checkbox"/>	<input checked="" type="checkbox"/>	<input checked="" type="checkbox"/>																																																																																																																																																																																																										
2	None			1	<input checked="" type="checkbox"/>	<input checked="" type="checkbox"/>	<input checked="" type="checkbox"/>	<input checked="" type="checkbox"/>	<input checked="" type="checkbox"/>																																																																																																																																																																																																										
3	None			1	<input checked="" type="checkbox"/>	<input checked="" type="checkbox"/>	<input checked="" type="checkbox"/>	<input checked="" type="checkbox"/>	<input checked="" type="checkbox"/>																																																																																																																																																																																																										
4	None			1	<input checked="" type="checkbox"/>	<input checked="" type="checkbox"/>	<input checked="" type="checkbox"/>	<input checked="" type="checkbox"/>	<input checked="" type="checkbox"/>																																																																																																																																																																																																										
5	None			1	<input checked="" type="checkbox"/>	<input checked="" type="checkbox"/>	<input checked="" type="checkbox"/>	<input checked="" type="checkbox"/>	<input checked="" type="checkbox"/>																																																																																																																																																																																																										
6	None			1	<input checked="" type="checkbox"/>	<input checked="" type="checkbox"/>	<input checked="" type="checkbox"/>	<input checked="" type="checkbox"/>	<input checked="" type="checkbox"/>																																																																																																																																																																																																										
7	None			1	<input checked="" type="checkbox"/>	<input checked="" type="checkbox"/>	<input checked="" type="checkbox"/>	<input checked="" type="checkbox"/>	<input checked="" type="checkbox"/>																																																																																																																																																																																																										
8	None			1	<input checked="" type="checkbox"/>	<input checked="" type="checkbox"/>	<input checked="" type="checkbox"/>	<input checked="" type="checkbox"/>	<input checked="" type="checkbox"/>																																																																																																																																																																																																										
9	None			1	<input checked="" type="checkbox"/>	<input checked="" type="checkbox"/>	<input checked="" type="checkbox"/>	<input checked="" type="checkbox"/>	<input checked="" type="checkbox"/>																																																																																																																																																																																																										
10	None			1	<input checked="" type="checkbox"/>	<input checked="" type="checkbox"/>	<input checked="" type="checkbox"/>	<input checked="" type="checkbox"/>	<input checked="" type="checkbox"/>																																																																																																																																																																																																										
11	None			1	<input checked="" type="checkbox"/>	<input checked="" type="checkbox"/>	<input checked="" type="checkbox"/>	<input checked="" type="checkbox"/>	<input checked="" type="checkbox"/>																																																																																																																																																																																																										
12	None			1	<input checked="" type="checkbox"/>	<input checked="" type="checkbox"/>	<input checked="" type="checkbox"/>	<input checked="" type="checkbox"/>	<input checked="" type="checkbox"/>																																																																																																																																																																																																										
13	None			1	<input checked="" type="checkbox"/>	<input checked="" type="checkbox"/>	<input checked="" type="checkbox"/>	<input checked="" type="checkbox"/>	<input checked="" type="checkbox"/>																																																																																																																																																																																																										
14	None			1	<input checked="" type="checkbox"/>	<input checked="" type="checkbox"/>	<input checked="" type="checkbox"/>	<input checked="" type="checkbox"/>	<input checked="" type="checkbox"/>																																																																																																																																																																																																										
15	None			1	<input checked="" type="checkbox"/>	<input checked="" type="checkbox"/>	<input checked="" type="checkbox"/>	<input checked="" type="checkbox"/>	<input checked="" type="checkbox"/>																																																																																																																																																																																																										
16	None			1	<input checked="" type="checkbox"/>	<input checked="" type="checkbox"/>	<input checked="" type="checkbox"/>	<input checked="" type="checkbox"/>	<input checked="" type="checkbox"/>																																																																																																																																																																																																										
17	None			1	<input checked="" type="checkbox"/>	<input checked="" type="checkbox"/>	<input checked="" type="checkbox"/>	<input checked="" type="checkbox"/>	<input checked="" type="checkbox"/>																																																																																																																																																																																																										
18	None			1	<input checked="" type="checkbox"/>	<input checked="" type="checkbox"/>	<input checked="" type="checkbox"/>	<input checked="" type="checkbox"/>	<input checked="" type="checkbox"/>																																																																																																																																																																																																										
19	None			1	<input checked="" type="checkbox"/>	<input checked="" type="checkbox"/>	<input checked="" type="checkbox"/>	<input checked="" type="checkbox"/>	<input checked="" type="checkbox"/>																																																																																																																																																																																																										
20	None			1	<input checked="" type="checkbox"/>	<input checked="" type="checkbox"/>	<input checked="" type="checkbox"/>	<input checked="" type="checkbox"/>	<input checked="" type="checkbox"/>																																																																																																																																																																																																										

Softkeys

2. Select from "**Key 1**" through "**Key 20**".
3. In the "**Type**" field, select **Paging**.
4. In the "**Label**" field, enter a label to apply to this key.
5. In the "**Value**" field, enter a multicast IP address and a port number for the Paging key. When you press this key, the phone initiates an outgoing multicast RTP session to the specified address using the specified port. (For example, 239.0.1.15:10000).

**Notes:**

1. When you select Paging for the "Type" field, the "Line" field is disabled.
 2. The "Value" field allows for one multicast address entry only.
-

6. To receive RTP streams for Group Paging, you must also configure the "**Paging Listen Addresses**" parameter at the path, *Basic Settings->Preferences->Group Paging RTP Settings*. For more information about setting this parameter, see "[Group RTP Paging \(receives RTP streams\)](#)" on [page 235](#).

Programmable Keys

7. Select from "**Key 1**" through "**Key 6**".
8. In the "**Type**" field, select **Paging**.
9. In the "**Value**" field, enter a multicast IP address and a port number for the Paging key. When you press this key, the phone initiates an outgoing multicast RTP session to the specified address using the specified port. (For example, 239.0.1.15:10000).

**Notes:**

1. When you select Paging for the "Type" field, the "Line" field is disabled.
 2. The "Value" field allows for one multicast address entry only.
-

10. To receive RTP streams for Group Paging, you must also configure the "**Paging Listen Addresses**" parameter at the path, *Basic Settings->Preferences->Group Paging RTP Settings*. For more information about setting this parameter, see "[Group RTP Paging \(receives RTP streams\)](#)" on [page 235](#).

Expansion Module Keys

11. Select from "**Key 1**" through "**Key 36**" (M670i)
or
Select from "**Key 1**" through "**Key 60**" (M675i)
12. In the "**Type**" field, select **Paging**.
13. (M675i) In the "**Label**" field, enter a label to apply to this key.

14. In the “**Value**” field, enter a multicast IP address and a port number for the Paging key. When you press this key, the phone initiates an outgoing multicast RTP session to the specified address using the specified port. (For example, 239.0.1.15:10000).



Notes:

1. When you select Paging for the “Type” field, the “Line” field is disabled.
2. The “Value” field allows for one multicast address entry only.

15. To receive RTP streams for Group Paging, you must also configure the “**Paging Listen Addresses**” parameter at the path, *Basic Settings->Preferences->Group Paging RTP Settings*. For more information about setting this parameter, see “[Group RTP Paging \(receives RTP streams\)](#)” on page 235.

16. Click  to save your changes

Using the Paging Key

The following procedure describes the use of the Paging key on the IP Phone. The procedure assumes you have already configured the Paging key using the Aastra Web UI.



IP Phone UI



Notes:

1. Recipient of a Paging call can set a global “Do Not Disturb” (DND) to ignore any incoming pages.
2. For incoming Paging, the phone uses the Intercom configuration settings. The incoming Page is dependant on the “Allow Barge-In” parameter setting and the “Idling/On Call” state.

1. On the IP Phone, press the softkey, programmable key, or expansion module key you configured for Paging (labeled as “**Group 1**” in the following illustration).

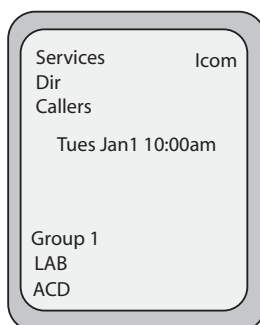

The phone opens a multicast RTP session and an outgoing OR incoming phone screen displays as follows.

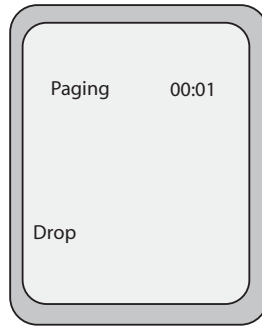

2. Press the **Drop** key to end the multicast RTP session and return to the idle screen.



Note: If you enable global DND on the phone, the incoming multicast RTP session is dropped.

None Key

You can set a softkey, programmable key, or expansion module key to force a blank entry on the IP phone display for a specific key. You do this by setting the key to "none". The keys are added in order (from key1 to key20) after any hard-coded keys have been added. If a particular key is not defined, it is ignored. For more information about key behavior, see [“Key Display Behavior”](#) on page 65.

Configuring a None Key

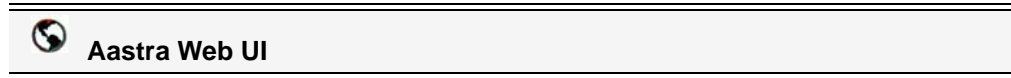

Use the following procedure to configure a None key on the 6755i IP Phone. The procedure shows the softkey screen as an example.

1. Click on **Operation->Softkeys and XML**.
or
Click on **Operation->Programmable Keys**.
or
Click on **Operation->Expansion Module <N>**.

Key	Type	Label	Value	Line	Idle	Connected	Incoming	Outgoing	Busy
1	WebApps			global	<input checked="" type="checkbox"/>	<input checked="" type="checkbox"/>	<input checked="" type="checkbox"/>	<input checked="" type="checkbox"/>	<input checked="" type="checkbox"/>
2	None			1	<input checked="" type="checkbox"/>	<input checked="" type="checkbox"/>	<input checked="" type="checkbox"/>	<input checked="" type="checkbox"/>	<input checked="" type="checkbox"/>
3	None			1	<input checked="" type="checkbox"/>	<input checked="" type="checkbox"/>	<input checked="" type="checkbox"/>	<input checked="" type="checkbox"/>	<input checked="" type="checkbox"/>
4	None			1	<input checked="" type="checkbox"/>	<input checked="" type="checkbox"/>	<input checked="" type="checkbox"/>	<input checked="" type="checkbox"/>	<input checked="" type="checkbox"/>
5	None			1	<input checked="" type="checkbox"/>	<input checked="" type="checkbox"/>	<input checked="" type="checkbox"/>	<input checked="" type="checkbox"/>	<input checked="" type="checkbox"/>
6	None			1	<input checked="" type="checkbox"/>	<input checked="" type="checkbox"/>	<input checked="" type="checkbox"/>	<input checked="" type="checkbox"/>	<input checked="" type="checkbox"/>
7	None			1	<input checked="" type="checkbox"/>	<input checked="" type="checkbox"/>	<input checked="" type="checkbox"/>	<input checked="" type="checkbox"/>	<input checked="" type="checkbox"/>
8	None			1	<input checked="" type="checkbox"/>	<input checked="" type="checkbox"/>	<input checked="" type="checkbox"/>	<input checked="" type="checkbox"/>	<input checked="" type="checkbox"/>
9	None			1	<input checked="" type="checkbox"/>	<input checked="" type="checkbox"/>	<input checked="" type="checkbox"/>	<input checked="" type="checkbox"/>	<input checked="" type="checkbox"/>
10	None			1	<input checked="" type="checkbox"/>	<input checked="" type="checkbox"/>	<input checked="" type="checkbox"/>	<input checked="" type="checkbox"/>	<input checked="" type="checkbox"/>
11	None			1	<input checked="" type="checkbox"/>	<input checked="" type="checkbox"/>	<input checked="" type="checkbox"/>	<input checked="" type="checkbox"/>	<input checked="" type="checkbox"/>
12	None			1	<input checked="" type="checkbox"/>	<input checked="" type="checkbox"/>	<input checked="" type="checkbox"/>	<input checked="" type="checkbox"/>	<input checked="" type="checkbox"/>
13	None			1	<input checked="" type="checkbox"/>	<input checked="" type="checkbox"/>	<input checked="" type="checkbox"/>	<input checked="" type="checkbox"/>	<input checked="" type="checkbox"/>
14	None			1	<input checked="" type="checkbox"/>	<input checked="" type="checkbox"/>	<input checked="" type="checkbox"/>	<input checked="" type="checkbox"/>	<input checked="" type="checkbox"/>
15	None			1	<input checked="" type="checkbox"/>	<input checked="" type="checkbox"/>	<input checked="" type="checkbox"/>	<input checked="" type="checkbox"/>	<input checked="" type="checkbox"/>
16	None			1	<input checked="" type="checkbox"/>	<input checked="" type="checkbox"/>	<input checked="" type="checkbox"/>	<input checked="" type="checkbox"/>	<input checked="" type="checkbox"/>
17	None			1	<input checked="" type="checkbox"/>	<input checked="" type="checkbox"/>	<input checked="" type="checkbox"/>	<input checked="" type="checkbox"/>	<input checked="" type="checkbox"/>
18	None			1	<input checked="" type="checkbox"/>	<input checked="" type="checkbox"/>	<input checked="" type="checkbox"/>	<input checked="" type="checkbox"/>	<input checked="" type="checkbox"/>
19	None			1	<input checked="" type="checkbox"/>	<input checked="" type="checkbox"/>	<input checked="" type="checkbox"/>	<input checked="" type="checkbox"/>	<input checked="" type="checkbox"/>
20	None			1	<input checked="" type="checkbox"/>	<input checked="" type="checkbox"/>	<input checked="" type="checkbox"/>	<input checked="" type="checkbox"/>	<input checked="" type="checkbox"/>

Services

XML Application URI:

XML Application Title:

BLF List URI:

Softkeys

2. Select from "Key 1" through "Key 20".
3. In the "Type" field, select **None**.

Programmable Keys

4. Select from "**Key 1**" through "**Key 6**"
5. In the "**Type**" field, select **None**.

Expansion Module Keys

6. Select from "**Key 1**" through "**Key 36**" (M670i)
or
Select from "**Key 1**" through "**Key 60**" (M675i)
7. In the "**Type**" field, select **None**.
8. Click  to save your changes.

Empty Key

You can set a softkey to force a blank entry on the IP phone display for a specific key. You do this by setting the softkey to **"empty"**. The keys are added in order (from key 1 to key 20) after any hard-coded keys have been added. If a particular key is not defined, it is ignored.

Configuring an Empty Key



Aastra Web UI

Use the following procedure to configure an Empty softkey on the 6755i phone.

1. Click on **Operation->Softkeys and XML**.
or
Click on **Operation->Programmable Keys**.
or
Click on **Operation->Expansion Module <N>**.

Status		Softkeys Configuration									
System Information		Key	Type	Label	Value	Line	Idle	Connected	Incoming	Outgoing	Busy
Operation		1	WebApps			global	<input checked="" type="checkbox"/>	<input checked="" type="checkbox"/>	<input checked="" type="checkbox"/>	<input checked="" type="checkbox"/>	<input checked="" type="checkbox"/>
User Password		2	None			1	<input checked="" type="checkbox"/>	<input checked="" type="checkbox"/>	<input checked="" type="checkbox"/>	<input checked="" type="checkbox"/>	<input checked="" type="checkbox"/>
Phone Lock		3	None			1	<input checked="" type="checkbox"/>	<input checked="" type="checkbox"/>	<input checked="" type="checkbox"/>	<input checked="" type="checkbox"/>	<input checked="" type="checkbox"/>
Softkeys and XML		4	None			1	<input checked="" type="checkbox"/>	<input checked="" type="checkbox"/>	<input checked="" type="checkbox"/>	<input checked="" type="checkbox"/>	<input checked="" type="checkbox"/>
Programmable Keys		5	None			1	<input checked="" type="checkbox"/>	<input checked="" type="checkbox"/>	<input checked="" type="checkbox"/>	<input checked="" type="checkbox"/>	<input checked="" type="checkbox"/>
Keypad Speed Dial		6	None			1	<input checked="" type="checkbox"/>	<input checked="" type="checkbox"/>	<input checked="" type="checkbox"/>	<input checked="" type="checkbox"/>	<input checked="" type="checkbox"/>
Directory		7	None			1	<input checked="" type="checkbox"/>	<input checked="" type="checkbox"/>	<input checked="" type="checkbox"/>	<input checked="" type="checkbox"/>	<input checked="" type="checkbox"/>
Reset		8	None			1	<input checked="" type="checkbox"/>	<input checked="" type="checkbox"/>	<input checked="" type="checkbox"/>	<input checked="" type="checkbox"/>	<input checked="" type="checkbox"/>
Basic Settings		9	None			1	<input checked="" type="checkbox"/>	<input checked="" type="checkbox"/>	<input checked="" type="checkbox"/>	<input checked="" type="checkbox"/>	<input checked="" type="checkbox"/>
Preferences		10	None			1	<input checked="" type="checkbox"/>	<input checked="" type="checkbox"/>	<input checked="" type="checkbox"/>	<input checked="" type="checkbox"/>	<input checked="" type="checkbox"/>
Account Configuration		11	None			1	<input checked="" type="checkbox"/>	<input checked="" type="checkbox"/>	<input checked="" type="checkbox"/>	<input checked="" type="checkbox"/>	<input checked="" type="checkbox"/>
		12	None			1	<input checked="" type="checkbox"/>	<input checked="" type="checkbox"/>	<input checked="" type="checkbox"/>	<input checked="" type="checkbox"/>	<input checked="" type="checkbox"/>
		13	None			1	<input checked="" type="checkbox"/>	<input checked="" type="checkbox"/>	<input checked="" type="checkbox"/>	<input checked="" type="checkbox"/>	<input checked="" type="checkbox"/>
		14	None			1	<input checked="" type="checkbox"/>	<input checked="" type="checkbox"/>	<input checked="" type="checkbox"/>	<input checked="" type="checkbox"/>	<input checked="" type="checkbox"/>
		15	None			1	<input checked="" type="checkbox"/>	<input checked="" type="checkbox"/>	<input checked="" type="checkbox"/>	<input checked="" type="checkbox"/>	<input checked="" type="checkbox"/>
		16	None			1	<input checked="" type="checkbox"/>	<input checked="" type="checkbox"/>	<input checked="" type="checkbox"/>	<input checked="" type="checkbox"/>	<input checked="" type="checkbox"/>
		17	None			1	<input checked="" type="checkbox"/>	<input checked="" type="checkbox"/>	<input checked="" type="checkbox"/>	<input checked="" type="checkbox"/>	<input checked="" type="checkbox"/>
		18	None			1	<input checked="" type="checkbox"/>	<input checked="" type="checkbox"/>	<input checked="" type="checkbox"/>	<input checked="" type="checkbox"/>	<input checked="" type="checkbox"/>
		19	None			1	<input checked="" type="checkbox"/>	<input checked="" type="checkbox"/>	<input checked="" type="checkbox"/>	<input checked="" type="checkbox"/>	<input checked="" type="checkbox"/>
		20	None			1	<input checked="" type="checkbox"/>	<input checked="" type="checkbox"/>	<input checked="" type="checkbox"/>	<input checked="" type="checkbox"/>	<input checked="" type="checkbox"/>
		Services XML Application URI: <input type="text"/> XML Application Title: <input type="text"/> BLF List URI: <input type="text"/>									

Softkeys

2. Select from **"Key 1"** through **"Key 20"**.
3. In the **"Type"** field, select **Empty**.
4. In the state fields, check (enable) or uncheck (disable) the states you want to apply to this softkey.

Programmable Keys

5. Select from "Key 1" through "Key 6"
6. In the "Type" field, select **Empty**.

Expansion Module Keys

7. Select from "Key 1" through "Key 36" (M670i)
or
Select from "Key 1" through "Key 60" (M675i)
8. In the "Type" field, select **Empty**.
9. Click  to save your changes.

Deleting a Key



Aastra Web UI

Use the following procedure to delete a key on the 6755i IP Phone. The procedure shows the softkey screen as an example.

1. Click on **Operation->Softkeys and XML**.
or
Click on **Operation->Programmable Keys**.
or
Click on **Operation->Expansion Module <N>**.

Key	Type	Label	Value	Line	Idle	Connected	Incoming	Outgoing	Busy
1	WebApps			global	<input checked="" type="checkbox"/>	<input checked="" type="checkbox"/>	<input checked="" type="checkbox"/>	<input checked="" type="checkbox"/>	<input checked="" type="checkbox"/>
2	None			1	<input checked="" type="checkbox"/>	<input checked="" type="checkbox"/>	<input checked="" type="checkbox"/>	<input checked="" type="checkbox"/>	<input checked="" type="checkbox"/>
3	None			1	<input checked="" type="checkbox"/>	<input checked="" type="checkbox"/>	<input checked="" type="checkbox"/>	<input checked="" type="checkbox"/>	<input checked="" type="checkbox"/>
4	None			1	<input checked="" type="checkbox"/>	<input checked="" type="checkbox"/>	<input checked="" type="checkbox"/>	<input checked="" type="checkbox"/>	<input checked="" type="checkbox"/>
5	None			1	<input checked="" type="checkbox"/>	<input checked="" type="checkbox"/>	<input checked="" type="checkbox"/>	<input checked="" type="checkbox"/>	<input checked="" type="checkbox"/>
6	None			1	<input checked="" type="checkbox"/>	<input checked="" type="checkbox"/>	<input checked="" type="checkbox"/>	<input checked="" type="checkbox"/>	<input checked="" type="checkbox"/>
7	None			1	<input checked="" type="checkbox"/>	<input checked="" type="checkbox"/>	<input checked="" type="checkbox"/>	<input checked="" type="checkbox"/>	<input checked="" type="checkbox"/>
8	None			1	<input checked="" type="checkbox"/>	<input checked="" type="checkbox"/>	<input checked="" type="checkbox"/>	<input checked="" type="checkbox"/>	<input checked="" type="checkbox"/>
9	None			1	<input checked="" type="checkbox"/>	<input checked="" type="checkbox"/>	<input checked="" type="checkbox"/>	<input checked="" type="checkbox"/>	<input checked="" type="checkbox"/>
10	None			1	<input checked="" type="checkbox"/>	<input checked="" type="checkbox"/>	<input checked="" type="checkbox"/>	<input checked="" type="checkbox"/>	<input checked="" type="checkbox"/>
11	None			1	<input checked="" type="checkbox"/>	<input checked="" type="checkbox"/>	<input checked="" type="checkbox"/>	<input checked="" type="checkbox"/>	<input checked="" type="checkbox"/>
12	None			1	<input checked="" type="checkbox"/>	<input checked="" type="checkbox"/>	<input checked="" type="checkbox"/>	<input checked="" type="checkbox"/>	<input checked="" type="checkbox"/>
13	None			1	<input checked="" type="checkbox"/>	<input checked="" type="checkbox"/>	<input checked="" type="checkbox"/>	<input checked="" type="checkbox"/>	<input checked="" type="checkbox"/>
14	None			1	<input checked="" type="checkbox"/>	<input checked="" type="checkbox"/>	<input checked="" type="checkbox"/>	<input checked="" type="checkbox"/>	<input checked="" type="checkbox"/>
15	None			1	<input checked="" type="checkbox"/>	<input checked="" type="checkbox"/>	<input checked="" type="checkbox"/>	<input checked="" type="checkbox"/>	<input checked="" type="checkbox"/>
16	None			1	<input checked="" type="checkbox"/>	<input checked="" type="checkbox"/>	<input checked="" type="checkbox"/>	<input checked="" type="checkbox"/>	<input checked="" type="checkbox"/>
17	None			1	<input checked="" type="checkbox"/>	<input checked="" type="checkbox"/>	<input checked="" type="checkbox"/>	<input checked="" type="checkbox"/>	<input checked="" type="checkbox"/>
18	None			1	<input checked="" type="checkbox"/>	<input checked="" type="checkbox"/>	<input checked="" type="checkbox"/>	<input checked="" type="checkbox"/>	<input checked="" type="checkbox"/>
19	None			1	<input checked="" type="checkbox"/>	<input checked="" type="checkbox"/>	<input checked="" type="checkbox"/>	<input checked="" type="checkbox"/>	<input checked="" type="checkbox"/>
20	None			1	<input checked="" type="checkbox"/>	<input checked="" type="checkbox"/>	<input checked="" type="checkbox"/>	<input checked="" type="checkbox"/>	<input checked="" type="checkbox"/>

Services

XML Application URI:

XML Application Title:

BLF List URI:

Softkeys, Programmable Keys, Expansion Module Keys

2. Choose the key you want to delete from the phone.
3. In the "**Type**" field, select **none**.
4. Click  to save your changes.

The key function is deleted from the IP phone memory.

Making Calls

This section describes ways to make calls on your 6755i phone, using your handset, speakerphone or headset.

Dialing a Number

First, take the phone off-hook by:

- lifting the handset
- pressing  or
- pressing a line/call appearance button
- At the dial tone, enter the number you wish to call

 **Note:** After dialing the number, the phone has a short delay before sending the call. To send the call immediately, you can press the "**Dial**" softkey (if the handset is offhook) or the "#" key immediately after dialing the number. The phone sends the call without delay.

If you are unable to make calls within certain area codes, check with your System Administrator for any toll restrictions placed on your extension that may restrict your access to long distance area codes or dialing prefixes.

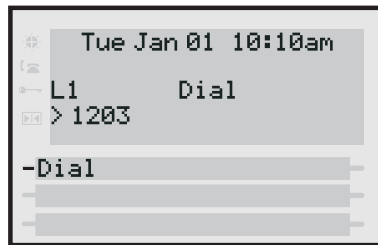

When your party picks up, a timer appears on your display that records the length of your call.

If the Live DialPad option is on, as soon as you press the first digit on the dial pad the phone automatically selects the next available line, go off-hook and dial as digits are pressed.

Pre-dialing a Number

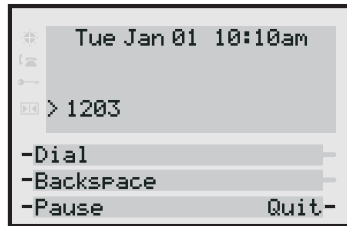





You can also make a call by pre-dialling a number. Pre-dialling lets you view a number before you dial. Use the **Backspace** softkey to correct any errors.

Using Handsfree Speakerphone

The handsfree feature allows you to speak to someone without using the handset or headset. Your phone must be in either the Speaker or Speaker/Headset audio mode. For more information about setting the audio mode on your phone, see [“Audio Mode”](#) on [page 34](#).



IP Phone UI

- To dial using handsfree, first press  and enter a number at the dial tone.
- To answer a call on your phone using handsfree, press  or the line/call appearance button.
- If you are in Speaker audio mode, lift the handset and press  to switch between handsfree and handset.
- If you are in Speaker/headset audio mode, press  to switch between handsfree and headset.
- When the handset is on hook, press  to disconnect the call.

When handsfree is on, the speaker light turns on.

Using a Headset

The 6755i accepts headsets through the modular RJ22 jack on the back of the phone. Contact your telephone equipment retailer or distributor to purchase a compatible headset.



Note: Customers should read and observe all safety recommendations contained in headset operating guides when using any headset.

Advanced Volume Controls for the Headset Mic

On the 6755i, there are 3 options for the headset microphone volume. For more information about the headset microphone, see “[Headset Mic Volume](#)” on [page 35](#).



IP Phone UI

To change this volume:

1. Press to enter the Options list.
2. Select **Preferences** and press **Select**.
3. Use 2 to scroll down to **Set Audio** and press **Select**.
4. Press 2 to scroll down to **Headset/Mic Volume** and press **Select**.
5. Press 2 to scroll down to **headset/mic volume** and press **Select**.
6. Use 2 to scroll down the list to select your desired volume.
7. Press **Enter** to save the setting.
8. Press **Done** to save changes and exit.
9. If you do not wish to save changes, press **Cancel** to return to the previous screen.



Note: By default, the volume for the headset microphone is set to medium.

To Make and Receive Calls Using a Headset



IP Phone UI

1. Ensure that you have selected a headset audio mode by accessing the Options list (under option **Preferences->Set Audio->Audio Mode** on the IP Phone).
2. Plug the headset into the jack.
3. Press the key to obtain a dial tone or to answer an incoming call. Depending on the audio mode selected from the options menu, a dial tone or an incoming call is received on either the headset or the handsfree speakerphone.
4. Press the key to end the call.

Using Intercom

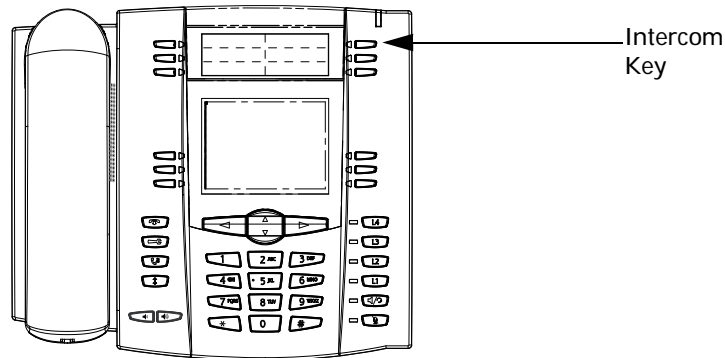

On the 6755i, you can use the **Icom** key to automatically connect with a remote extension. By default, the Icom key is configured as Key 4 on the top set of keys.



Using the Icom Key



IP Phone UI

1. Press the **Icom** key.
2. Enter the extension number of the person you wish to intercom or the BLF key for that extension.
3. After a beep tone, your phone automatically connects with the remote extension and you can speak through its speaker.
4. To cancel intercom, press  or the **Cancel** key.
5. When you are finished speaking, hang up the phone by placing the handset back on-hook or by pressing  or the line/call appearance button for the active call. When you hang up, the remote phone also hangs up.

You can set specific incoming Intercom call features on the 6755i IP phone using the Aastra Web UI. The following table describes these features.

Incoming Intercom Features in Aastra Web UI	Description
Microphone Mute	Allows you to enable or disable the microphone on the IP phone for Intercom calls made by the originating caller.
Auto Answer	Allows you to enable or disable the IP phone to automatically answer an Intercom call. If auto-answer is enabled on the IP phone, the phone plays a tone (if "Play Warning Tone" is enabled) to alert the user before answering the intercom call. If auto-answer is disabled, the phone rejects the incoming intercom call and sends a busy signal to the caller.
Play Warning Tone	Allows you to enable or disable a warning tone to play when the phone receives an incoming intercom call on an active line.
Allow Barge In	Allows you to enable or disable how the phone handles incoming intercom calls while the phone is on an active call.

For more information about the incoming Intercom features and for procedures on setting these features, see [“Incoming Intercom Call Features”](#) on [page 231](#).

Redial



IP Phone UI

- Press to dial the most recent number you dialed from the phone.
- If you are off-hook and press the last number you called is called back.
- If you are on-hook and press , a **Redial Directory** list appears on-screen.

The redial list is available during active calls. It stores up to the last 100 numbers you called, allowing you to scroll through and select the number you wish to redial.



Note: Your System Administrator can set your Redial key to speedial a specific number. Contact your System Administrator for more information.

Accessing the Redial List



IP Phone UI

1. If you are off-hook and press , the telephone automatically dials the last number you called.
2. If you are not on the phone, press to display the most recently dialed number and use 2 and 5 to scroll through the list to view the other numbers.
3. Press 2 to see the second most recently dialed number, or 5 to see the oldest call on your list.
4. To dial the displayed number press , or lift the Handset or press any line keys.
5. Press or the key to cancel.



Note: The redial list is available during active calls. It also stores up to the last 100 numbers you called, allowing you to scroll through and select the number you wish to redial.

Deleting from the Redial List.



Note: You cannot delete individual entries in the Redial List.



IP Phone UI

Delete All Items



1. Press .
2. Press the **Delete** Key, then press the **Delete** Key again at the prompt to erase all items.

Mute

You can use the Mute  key to mute the handset, headset, or speakerphone. When you use the mute key on your phone, you cannot be heard on an active call or on a conference. For muted calls, the handsfree LED flashes and the Mute key LED is ON.



IP Phone UI

You can use the Mute  key to mute the handset, headset, or speakerphone. The speaker light flashes slowly and you can hear the caller, but they cannot hear you. To switch mute on or off, press .



Note: If you place a muted call on hold, the phone automatically takes the call off mute when you reconnect to the call.

Receiving Calls

When a call is ringing at your extension, the inbound callers extension and name display to the screen. The line/call appearance light flashes quickly for the incoming call.





Answering an Incoming Call



IP Phone UI

To answer the call

- For handsfree operation, press  or the line/call appearance button for the incoming call.
- Press  for handsfree or headset operation.
- Lift the handset for handset operation.



Note: The audio mode setting you have selected in the options list under **Headset Settings** determines if the call goes to handsfree or headset operation. For more information, see the section “[Customizing Your Phone](#)” on [page 27](#).



If the phone is already connected to a call, pressing the line/call appearance button for the new incoming call automatically places the connected call on hold and answers the new call. To reconnect to a party, press the line/call appearance button for that call.

If you cannot answer the call, the caller goes to voicemail if voicemail has been configured for your extension.



Note: The  button can be used to cancel the call pickup procedure.

Sending an Incoming Call to Voicemail

You can send an incoming call directly to voicemail without answering the call. To do this, press  without picking up the handset. If you're already on the phone your incoming call should go directly to voicemail. Your phone screen displays a voicemail icon () along with the number of waiting messages, if you have unheard messages (example:  x4).

Handling Calls

When you are connected to a call, you can use the softkeys or hard keys on the phone to place a call on hold, transfer a call, or conference.

Placing a Call on Hold

You can place an active call on hold by pressing the Hold  key. When you place a call on hold, only your phone can retrieve the call.



IP Phone UI

To place a call on hold

1. Connect to the call (if not already connected).
2. Press the Hold  key.



The line/call appearance light begins to flash slowly and after a short time the phone beeps softly to remind you that you still have a call on hold. The screen displays "**Call Held**" with the line number the call is held at the phone.



Note: If you are connected to another call, the phone does not beep to remind you that you still have a call on hold.

When on Hold

To let your caller know that they are still on hold, music plays softly (if this has been set up for your system). The call/line appearance light for the line you are on remains solid to indicate that you are still connected.



Automatic Hold

When juggling between calls, you do not have to press the hold button to go from one call to the next. The phone automatically puts your current call on hold as soon as you press a new line/call appearance button. If you have more than one call on hold, you can reconnect to a held call by pressing the line/call appearance button where that call is being held. Press  to disconnect the call.

Retrieving a Held Call

If you have more than 1 call on hold, you can scroll through the held call information by pressing 3 and 4 navigation keys. To reconnect to a call press the line/call appearance button where that call is being held. If you press the call/line appearance button again, you disconnect from the call.

Transferring Calls

Blind Transfer

A blind transfer is when you transfer a call directly to another extension without consulting with the person receiving the call. To do this, simply complete the transfer immediately after you have entered the number. The call goes directly to the extension or outside line you transferred to. If the party you are transferring the call to does not answer, the transferred call rings back to your extension.

Consultative Transfer

You also have the option to consult with the person you are transferring the call to, before you complete the transfer. To do this, simply remain on the line until the receiving party answers the call. After consulting with the receiving party, you can either complete the transfer or cancel the transfer to go back to the original call.



IP Phone UI

When you lift the handset on the phone, the **Transfer** key displays on the bottom set of softkeys by default. Use this key to transfer calls.



Screen that displays when handset is lifted

Use the following procedure to transfer a call to another extension. Use the following illustration as a reference.

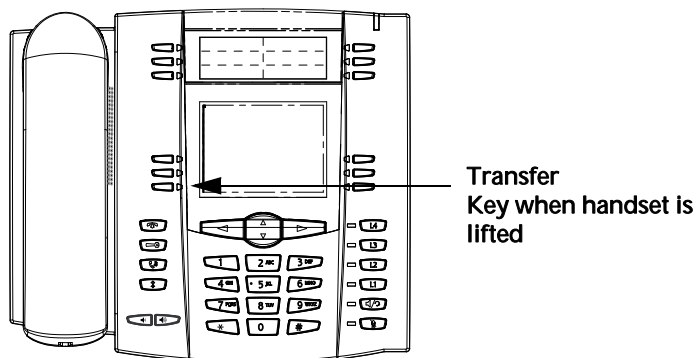

To transfer a call to another extension

1. Connect to Party 1 (if not already connected). Party 1 is the party you want to transfer.
2. Press the **Transfer** key. You should hear a dial tone as a second line opens up.
3. Press a line/call appearance button followed by the extension number (or the outside number) to Party 2. This is the Party for which you want to transfer Party 1
4. To complete a "blind" transfer, press the **Transfer** Key again before the receiving end answers. To complete a consultive transfer, remain on the line to speak with the Party 2, before pressing the **Transfer** Key again to transfer Party 1 to Party 2. To cancel the transfer, select **Cancel** on the display screen or press .

Transferring Two Existing Calls

The 6755i allows you to perform a transfer of a call when there are currently two active calls on the phone. For example, on your phone, there are two active calls - Call A and Call B. Call B is on hold. You can perform the following to transfer Call A to Call B:

1. Press **Xfer** key. A new line opens.
2. Press or scroll to the **Line** where Call B is on hold.
3. Press **Xfer** key.

Call A is transferred to Call B.

Conferencing Calls

The 6755i IP phone offers two methods of conferencing:

- Local conferencing (default method).
- Centralized conferencing (for Sylanro and Broadsoft Servers) (Administrator must enable this method).

When you lift the handset on the phone, the **Conference** key displays on the bottom set of softkeys by default. Use this key to create conference calls.



Screen that displays when handset is lifted

Local Conferencing

The 6755i phone supports up to 3 parties (including yourself) in a conference call. This is called Local Conferencing and is the default method of conferencing on the 6755i.



Note: Your System Administrator can set your Conference key to speedial a specific number. Contact your System Administrator for more information.

Using Local Conferencing



IP Phone UI

Use the following procedure to create a conference call using local conferencing. Use the following illustration as a reference.

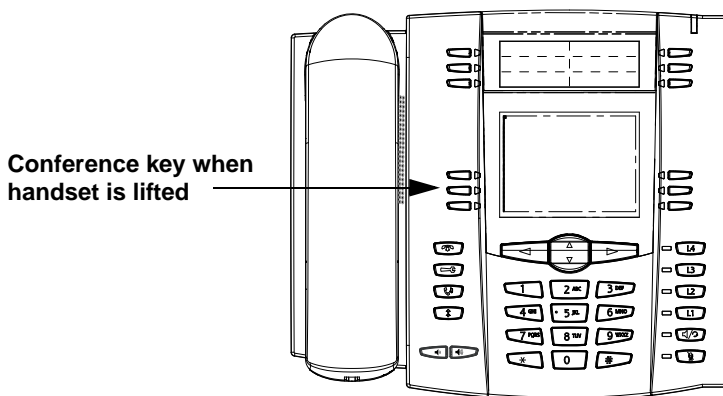

1. When you begin a conference, you are the first party in the conference (Party 1). Pickup the handset or press the speakerphone key. A line opens up.
2. Call Party 2 by dialing their number (or answer an incoming call of a Party).
3. Wait for Party 2 to answer. When Party 2 answers, you can consult with them before adding them to the conference.
4. Press the **Conf** Key. A new line opens.

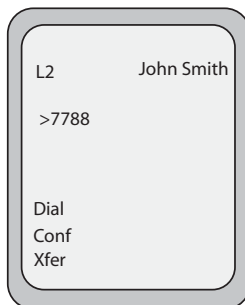

5. Enter the phone number of Party 3.
6. Wait for Party 3 to answer. When Party 3 answers, you can consult with them before adding them to the conference.
7. Press the **Conf** key again to add Party 3 to the conference. Party 1 (which is yourself), Party 2, and Party 3 are all connected to a single conference.
8. To drop a party from the conference, press the **Conf** key once more.



Note: You can use 2 and 5 to scroll through and see the numbers and names (if available) of the parties in the conference call. When a name is displayed, pressing 4 drops the displayed party from the call.

Joining Two Active Calls in a Single Conference



IP Phone UI

1. Begin with active calls on two different lines (for example, Line 1 and Line 2 have active calls).
2. Press the **Line** key for which you want to conference the two calls together (for example, Line 1).
3. Press the **Conf** key.
4. Press the **Line** key that has the second active call (for example, Line 2).
5. Press the **Conf** key. The two active calls link into a conference call on Line 1.



Note: You can use 2 and 5 to scroll through and see the numbers and names (if available) of the parties in the conference call. When a name is displayed, pressing 4 drops the displayed party from the call.

Centralized Conferencing (for Sylanro and Broadsoft Servers)

The 6755i allows you to create multiple conferences with unlimited participants (depending on your server limitations) when your Administrator enables Centralized Conferencing.

If your Administrator does not enable Centralized Conferencing, then the 6755i uses Local Conferencing by default.

Your Administrator can configure Centralized Conferencing globally on all lines or on specific lines. Although, for the global setting to work, you must configure the lines with the applicable phone number.

Reference

For more information on Centralized Conferencing, see [“Centralized Conferencing”](#) on page 242 or contact your System Administrator.

Using Centralized Conferencing



IP Phone UI



Note: When Centralized Conferencing is enabled on your phone, local conferencing (or three-way conferencing) works as indicated in the previous section, “Using Local Conferencing” on page 166. Joining two active calls in a conference also works as indicated in the previous section, “Joining Two Active Calls in a Single Conference” on page 167.

Use the following procedure to create a conference call using centralized conferencing. Use the following illustration as a reference.

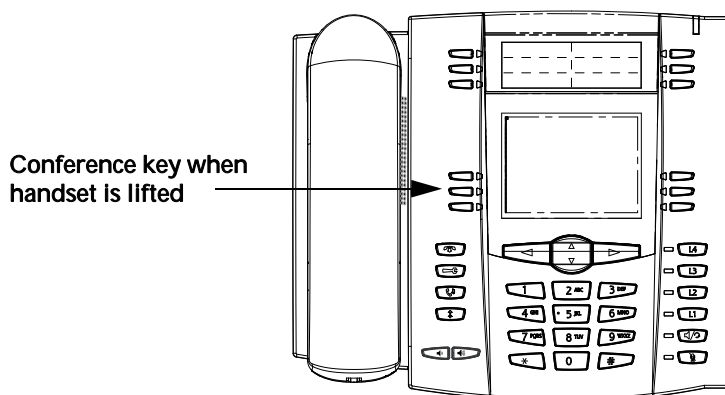

Setting Up a Conference and Adding Multiple Parties (for Sylanro and Broadsoft Servers)



Note: You can have an unlimited number of parties in a conference (dependent on the limitations of the server).

1. When you begin a conference, you are the first party in the conference (Party 1). Pickup the handset or press the Speakerphone Key. A line opens up.
2. Call Party 2 by dialing their number (or answer an incoming call of a Party).
3. Wait for Party 2 to answer. When Party 2 answers, you can consult with them before adding them to Conference 1.

4. Press the **Conf** Key. A new line opens.



5. Enter the phone number of Party 3.
6. Wait for Party 3 to answer. When Party 3 answers, you can consult with them before adding them to the Conference 1.
7. Press the **Conf** Key again to add Party 3 to Conference 1. Party 1 (which is yourself), Party 2, and Party 3 are all connected to Conference 1.
8. Press an available **Line** Key (or answer an incoming call on an available line). If calling out, call Party 4.
9. Wait for Party 4 to answer. When Party 4 answers, you can consult with them before adding them to the conference.
10. Press the **Conf** Key to add Party 4 to Conference 1.
11. Press the **Line** Key that has Conference 1.
12. Press the **Conf** Key to join all parties (Parties 1 through 4) on Conference 1.
13. To add more parties, repeat steps 8 through 12.



Note: You can use 2 and 5 to scroll through and see the numbers and names (if available) of the parties in the conference call. When a name is displayed, pressing 4 drops the displayed party from the call.

If any party in the conference hangs up (including the party that began the conference), all other parties in the conference are still connected.

Setting Up Multiple Conferences (for Sylantrio Server only)



Note: The 6755i is limited to 9 conferences (a single conference each on lines 1 through 9).

1. Start Conference 1 using the procedures in the previous section, [“Setting Up a Conference and Adding Multiple Parties \(for Sylantrio and Broadsoft Servers\)”](#) on page 168.
2. When you are finished adding all required parties to Conference 1, press an available **Line** Key to start Conference 2. You are Party 1 on Conference 2. Call Party 2.
3. When Party 2 answers, press the **Conf** Key.
4. Press an available **Line** Key.

5. Call Party 3 for Conference 2.
6. When Party 3 answers, press the **Conf** Key to join Parties 1 (which is yourself), Party 2, and Party 3 on Conference 2.
You now have two active conferences on two different lines.



Note: When you are connected to multiple conference calls, and you put a conference on hold, the conference may be on hold for a limited period of time before it is disconnected. Contact your System Administrator for more information.

If any party in a conference hangs up (including the party that began the conference), all other parties in the conference are still connected.

Joining Additional Parties to Active Conferences

In centralized conferencing, you can join multiple incoming or outgoing calls to active conferences. Before following this procedure, at least one active conference must exist on your phone.

1. As Party 1, pickup the handset or press the speakerphone key.
A line opens up.
2. Call Party 2 by dialing their number (or answer an incoming call of a Party).
3. Wait for Party 2 to answer. When Party 2 answers, you can consult with them before adding them to the conference.
4. Press the **Conf** Key.
5. Press the **Line** Key that has the active conference. (For example, Line 1 and Line 2 both have active conferences. Pressing Line 1 joins Party 1 and Party 2 to the conference on Line 1. Pressing Line 2 joins Party 1 and Party 2 to the conference on Line 2.)
6. Press the **Conf** Key again to join the Parties to the active conference.

Ending a Conference and Transferring Remaining Parties

The 6755i allows a Host to drop from a 3-way conference and let the other two parties remain connected by pressing a **Transfer** key.



Note: The Caller ID of the dropped Host still displays on the remaining parties' phones.

If you are the Host of a conference and want to leave that conference:

- While in a 3-way conference press the **Transfer** key on the phone.

Your phone leaves the 3-way conference but the remaining parties are still connected to the conference.

Ending Calls



IP Phone UI

To end a call, you first need to connect or reconnect to the call if not already connected (for example, if your caller is on hold). Press  or the line/call appearance button of the active call to end the call. If connected through the handset, you can also place the handset back on hook to end the call.

Managing Calls

The 6755i has several features that make it easier to manage calls, and to keep track of your caller history, as well as your business and personal contacts.

These features include:

- Directory List
- Callers List
- Call Forwarding
- Missed Calls Indicator
- Voicemail

Directory List

The Directory List is your personal phone book, conveniently stored within your phone. You can enter up to 200 entries into the 6755i Directory by adding them manually, or by saving the number and name from other lists stored on your phone. You can also dial directly from a directory entry. On the 6755i, you access the Directory by pressing Key 2 which is the **Directory** key.

Accessing Your Directory



IP Phone UI

Use the following procedure to access your Directory List. Use the following illustration as a reference.

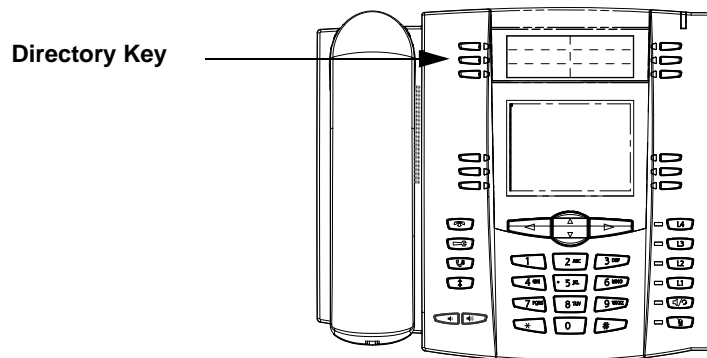

1. Press the **Directory** Key. The directory displays the number of entries in your list. If the Directory list is empty, "*Directory Empty/Use Save to add*" displays. The following is an example of the Directory List Header screen with 97 entries in the List.



2. You can access entries by pressing 2 and 5 to scroll through the list.
3. To search for an entry by name, press the dial pad number corresponding to the first letter of the name (for example, press **7** for the letter **P**). Continue to press the dial pad number to access other letters on the same key (for example, press **7** three times for 'RON'). If there are multiple entries under the same letter, you can use 2 and 5 to scroll through the list, or continue to press the next letters of the name to find a better match.
4. To dial the displayed number press  or just lift the handset or press any line keys.
5. Press the **Directory** Key to cancel.

Sorting Entries and Quick Search Feature

You can sort multiple numbers according to preference and perform a quick-search feature that allows you to enter the first letter that corresponds to a name in the Directory to find specific line items. The phone displays the first name with this letter.



Note: The quick-search feature in the Directory List works only when the Directory is first accessed.

Managing the Directory List

From the Directory List in the IP Phone UI, you can perform the following:

- [“Adding New Entries to the Directory List”](#) (page 174)
- [“Editing Entries in the Directory List”](#) (page 175)
- [“Deleting Entries from the Directory List”](#) (page 178)
- [“Saving Entries to the Directory List”](#) (page 179)

Adding New Entries to the Directory List

You can store a maximum of 7 numbers associated with a unique name. You can apply pre-defined labels to the entry which include, Office, Home, Cell, and Pager, or create your own labels. The following table indicates the maximum characters for each line and field in the Directory List.

Directory List Limitations	
Maximum length of a line	255 characters
Maximum length of a name	16 characters
Maximum length of a label	14 characters
Maximum length of a URI	45 characters
Maximum number directory entries in the NVRAM	200 entries

The following examples illustrate the IP Phone UI screens you can use to add entries in the Directory List.

Screen 1

Screen 2

Adding Names, Numbers, Labels



IP Phone UI

On Screen 1:

- You can add names using the **abc** softkey.
- You can add numbers (up to 7 numbers per name) using the numbers on the phone's keypad.
- Use the **Backspace** softkey when required.
- Use the **Save** softkey when you are finished adding the name and number(s).
- You can exit from Screen 1 at any time without saving by pressing the **Cancel** softkey.



Note: Use the 2 and 5 keys to toggle between Screen 1 and Screen 2.

On Screen 2:

- You can add a label or URI using the **abc** softkey; Or you can populate the "Label" field with a pre-defined label (Office, Home, Cell, Pager) by pressing the **Label** softkey.
- Use the **Backspace** softkey when required.
- Use the **Save** softkey when you are finished adding the Label.
- You can exit from Screen 2 at any time without saving by pressing the **Cancel** softkey.

Editing Entries in the Directory List



IP Phone UI

On Screen 1, when the cursor is in the "Line" field, softkey 5 displays a **Change** softkey. The following example illustrates a Directory entry for "Steve Smith", with a phone number and an "Office" label. Since the cursor is in the "Line" field, the **Change** softkey displays.



The following example shows the same Directory entry without a label.

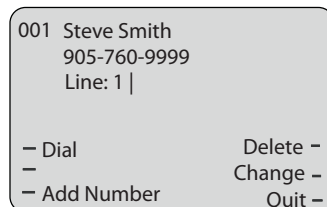

- You can use the **Dial** softkey to automatically dial the number in the Directory entry.
- You can use the **Add Number** softkey to add additional numbers to the current Directory entry (up to 7 numbers per name).
- You can use the **Delete** softkey to delete a number or to delete multiple numbers in an entry (see [“Deleting Entries from the Directory List”](#) on page 178).
- You can use the **Change** softkey to change a number or a name.
- You can use the **Quit** softkey to quit the editing of the current Directory entry.

Scrolling Multiple Screens Per Entry

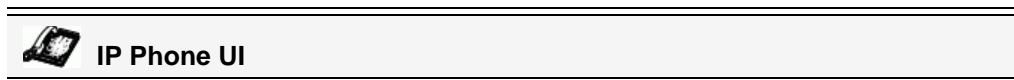

If there are multiple numbers for an entry, the 3 and 4 keys display for you to scroll multiple screens. The following examples show **Screen 1** as Steve Smith’s Office number, **Screen 2** as Steve Smith’s Home number, and **Screen 3** as Steve Smith’s Cell number. The first scroll 4 indicates there are multiple number entries for the name. The 3 and 4 indicates you can scroll forward or backward between screens. The 3 indicates this is the last number entry for the name.

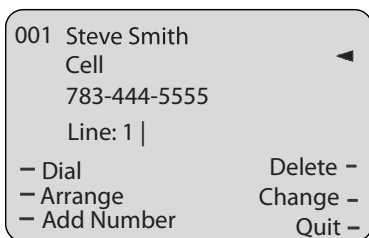

Arranging Multiple Screens

You can use the **Arrange** softkey to move the number/label/line forward or backward between screens for the specified name. If there is a label assigned to the entry, the following screen displays after pressing the **Arrange** softkey.

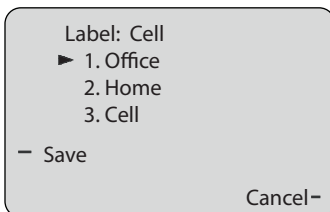

- Pressing the **Save** softkey in the above screen places the Cell label, the Cell number, and line associated with the Cell number, into the one position. So the first screen to display for the entry would be the Cell number screen. If no label is assigned to the entry, the numbers would be arranged in the order you specify.

The following example illustrates the new arrangement of Steve Smith's number.



Note: The Office label moves to the second position and the Home label moves to the last position.

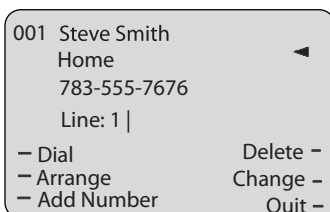
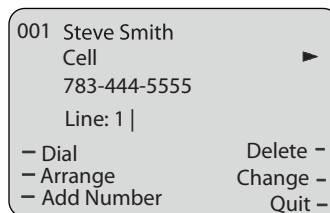

Deleting Entries from the Directory List

You can delete entries from the Directory List in the following ways:

- Delete a single name or number and all associated numbers and labels.
- Delete specific numbers and labels from a single entry
- Delete all entries in the Directory List

You use the Delete softkey to delete a single or multiple numbers, names, or labels for an individual entry.



IP Phone UI

To delete a single entry from the Directory List:

1. Scroll to a name or number in the Directory List.
2. Press **Delete**. The following screen displays.

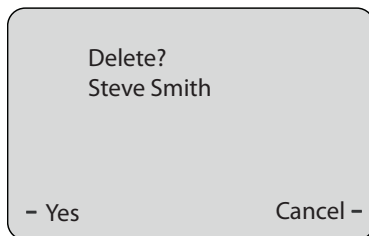

3. Press **Yes** to delete the directory entry (name, number, label, and line) from the Directory List.
4. Press **Cancel** to cancel the delete function.

To delete specific numbers, names or labels for an entry:

1. Scroll to a name or number in the Directory List that has multiple numbers and/or labels assigned to the entry.
2. Press **Delete**. The following screen displays.

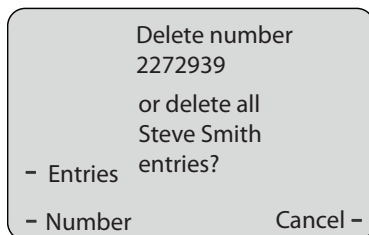

3. Press **Number** to delete only a specific number associated with a name.
4. Press **Entries** to delete the entire directory entry (name, all numbers, labels, and lines associated with the name) from the Directory List.
5. Press **Cancel** to cancel the delete function.

To delete all entries from the Directory List:

1. Press the **Directory** key.

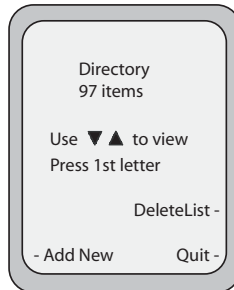

2. At the “Directory List” top screen, press **DeleteList**.

Saving Entries to the Directory List

You can save entries (names and numbers) from other sources to your Directory using any of the following methods:

- Save from the Display
- Save from the Caller List
- Save from the Redial List

Saving from the Display

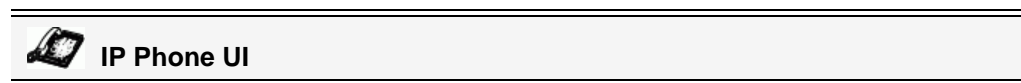

You can save the name, number, and/or label displayed on your screen during an active call to the Directory List using the following procedure. Use the following illustration as a reference.

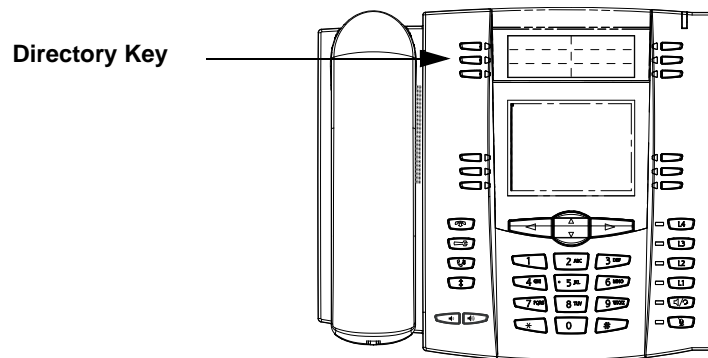

1. During an active call, while the name, number, and/or label of the incoming caller displays to the LCD, press the **Directory** key.
2. Press the **Add New** key.

The name and/or number from the active call gets stored to the Directory.

Saving from the Callers List



IP Phone UI

You can save a name, number, and/or label from the Callers List to the Directory List using the following procedure. Use the following illustration as a reference.

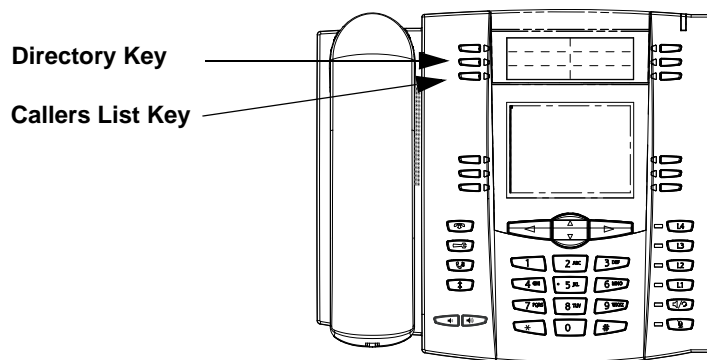

1. Press the **Callers List** key.
2. Scroll to the entry you want to copy to the Directory List.
3. Press **Copy**. The entry is saved in the Directory List.

Saving from the Redial List



IP Phone UI

You can save a name, number, and/or label from the Redial List to the Directory List using the following procedure. Use the following illustration as a reference.

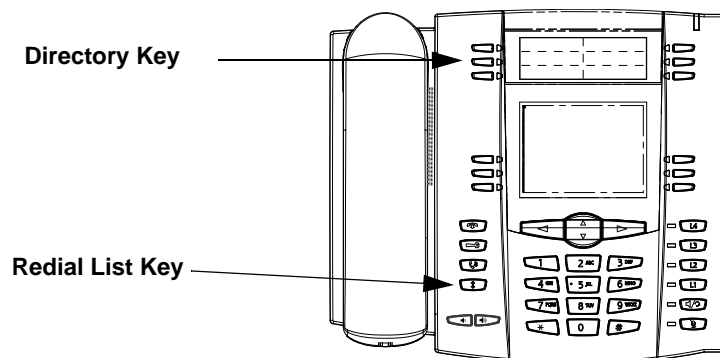

1. Press the  (**Redial List**) key.
2. Scroll to the entry you want to copy to the Directory List.
3. Press **Copy**. The entry is saved in the Directory List.

Downloading the Directory List to Your PC

You can download the Directory List to your PC via the Aastra Web UI. The phone stores the *directorylist.csv* file to your PC in comma-separated value (CSV) format.

You can use any spreadsheet application to open the file for viewing. The following is an example of a Directory List in a spreadsheet application.

	A	B	C	D	E	F
1	John	41373	2			
2	Tim	41376	1			
3	Carol	4443245	1			
4	Tom	41356	3			
5						
6						
7						
8						
9						
10						
11						
12						

The file displays the name, phone number, and line number for each Directory entry.



Note: Your System Administrator can populate your IP phone Directory List with server directory files. Contact your System Administrator for more details.

Download the Directory List

Use the following procedure to download the Directory List to your PC using the Aastra Web UI.

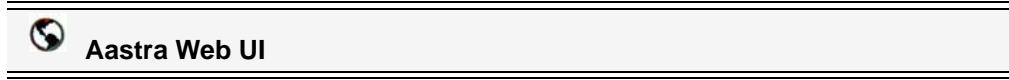

1. Click on **Operation->Directory**.

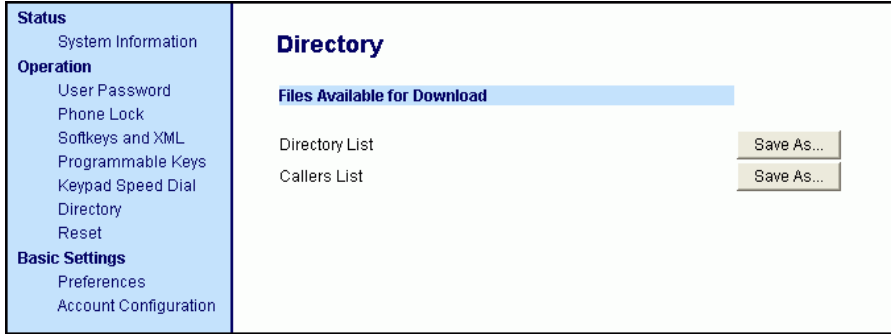

2. In the Directory List field, click on . A File Download message displays.
3. Click **OK**.
4. Enter the location on your computer where you want to download the Directory List and click **SAVE**.
The *directorylist.csv* file downloads to your computer.
5. Use a spreadsheet application to open and view the Directory List.

Accessing the Directory List

Use the following procedures to access the Directory List.

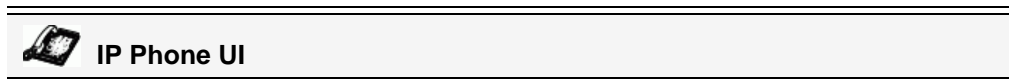

1. Press the **Services** key on the phone to display the **Services** menu, and select "**Directory List**".
or
Press the **Directory** softkey (default key is key 2 on the Top Keys).
2. Use the 2 and 5 keys to scroll through the line items in the Directory List.
3. To dial a displayed entry from the Directory List, pick up the handset, press the  handsfree key, or press the **Dial** softkey.
4. To exit the Directory List, press the **Quit** softkey.

Callers List





The Callers list is a stored log of your incoming calls. The 6755i telephone stores information on up to 200 incoming calls in the Callers list. Your telephone logs the number and name (if available) of the caller, when they last called, and the number of times they tried to reach you.

When the Callers list is full, the oldest call records are deleted to accommodate the information of new callers.

If the telephone number of an incoming or outgoing call matches a number that you have programmed with a name in a programmable key or the Directory, the Callers list display the name and number.

The display shows you how many callers have been added to the list since you last checked it.

Caller's List Screen Display

Display Item	Description
450-349-0438	Indicates you have returned the call from the Callers list.
N MAR 04 3:30pm 2x	"N" indicates a new call.
XX New Callers	When you're not on the telephone and not in the Callers list, the display shows you how many callers have been added to the list since you last checked it.
	Indicates an unanswered call in the Callers list.
	Indicates an answered call in the Callers list.
	Indicates a Call Waiting call in the Callers list.
	Indicates an incoming Call Waiting call.
John Burns 9054550055 Jun 8 2:41pm 2X	"2x" indicates this caller has called twice. The display shows the date and time of the last call from that caller.

You can view, scroll, and delete line items in the Callers List from the IP phone UI. You can also directly dial from a displayed line item in the Callers List.

Accessing the Callers List



IP Phone UI

Use the following procedure to access the Callers List. Use the following illustration as a reference.

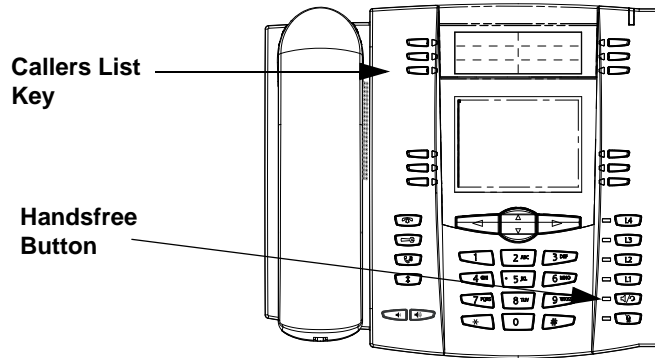

1. Press the **Callers List** key.
or
Press the **Services** key if your System Administrator has configured the Services key to access the Callers List.
2. Use the 5 keys to scroll through the line items in the Callers List.



Note: To the left of a line item, a  icon displays with the handset ON or OFF the receiver. The ON receiver indicates the call came in as a missed call. The OFF receiver indicates the call came in and was answered.

3. To delete all entries in the Callers list, press the **Delete** softkey at the "Callers List" header.
To delete a line item from the Callers List, select the line item you want to delete and press the **Delete** softkey.
4. To cancel a delete function, press the 2 or the 5 **Scroll** keys.
5. To save a line item to a softkey for speeddialing, press the **Save** softkey and enter the line number at the "Save to?" prompt that is already configured for speeddialing at a softkey.
6. To dial a displayed entry from the Callers List, pick up the handset, press the , or press a line key.
7. To exit the Callers List, press the **Callers List** key.

Editing Entries in the Callers List

Important: The Caller List does not save changes. Editing in the Callers List is generally used if you plan to call the number and need to add a prefix.

In the Callers List, if a dial pad key is pressed when a number and/or a name is displayed, the cursor automatically adds the digit at the left side of the number to enable the entry of the prefix.

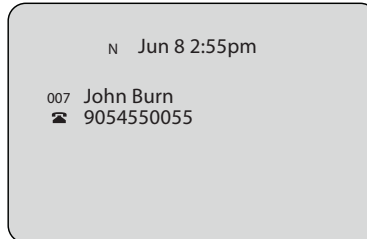

IP Phone UI

Use the following procedure to edit the Callers List. Use the following illustration as a reference.

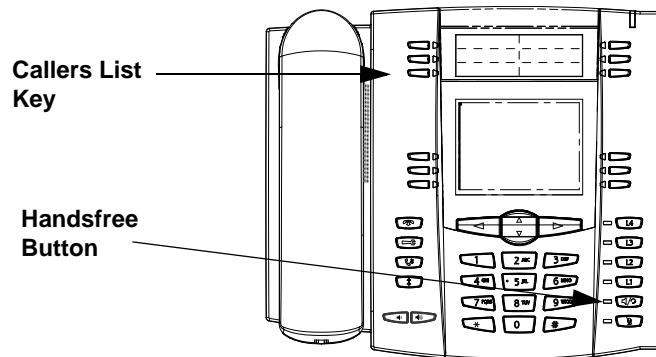

1. Press the **Callers List** Key.
2. Press 2 and 5 to find the entry you want to edit. Press 2 to view the most recent call, or 5 to see the oldest call on your list.
3. Press any key on the dial pad to begin editing.
4. To move the cursor one digit to the right, press 4. To erase one digit to the left of the cursor, press 3.
5. To dial the displayed number press , or just lift the handset, or press any line keys.

Deleting Entries from the Callers List

You can delete individual items from the Callers List, or you can delete all items in the Callers List.



Use the following procedure to delete an individual item from the Callers List. Use the following illustration as a reference.

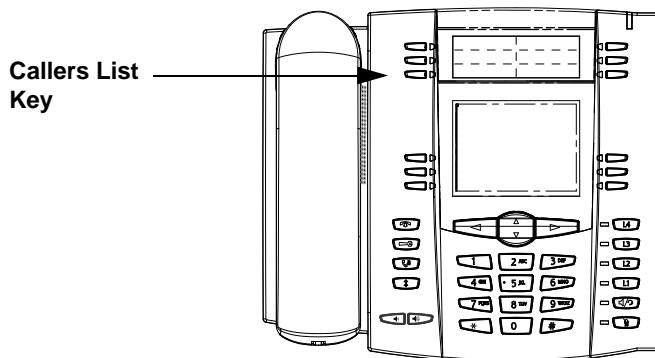

1. Press the **Callers List Key**.
2. Use 2 and 5 keys to find the item you want to delete.
3. Press the **Delete** softkey.
4. Press the **Delete** softkey again at the prompt to erase the item.



Use the following procedure to delete all items from the Callers List.

1. Press the **Callers List Key**.
2. Press the **Delete** softkey.
3. Press the **Delete** softkey again at the prompt to erase all items.

Downloading the Callers List to Your PC

You can download the Callers List to your PC for viewing using the Aastra Web UI. When you download the Callers List, the phone stores the *callerlist.csv* file to your computer in comma-separated value (CSV) format.

You can use any spreadsheet application to open the file for viewing. The following is an example of a Callers List in a spreadsheet application. This file displays the name, phone number, and the line that the call came in on.

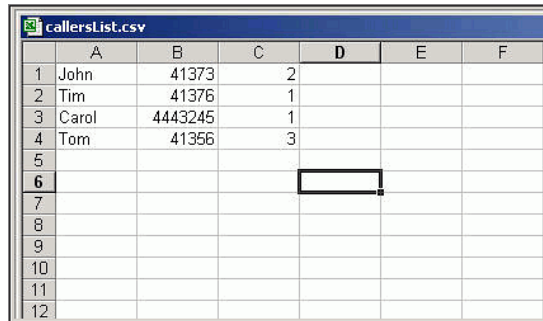

	A	B	C	D	E	F
1	John	41373	2			
2	Tim	41376	1			
3	Carol	4443245	1			
4	Tom	41356	3			
5						
6						
7						
8						
9						
10						
11						
12						

Download the Callers List

Use the following procedure to download the Callers List to your PC using the Aastra Web UI.



1. Click on **Operation->Directory**.

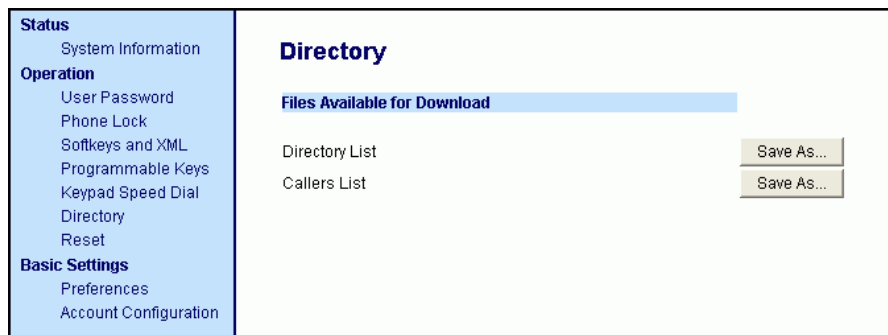

2. In the Callers List field, click on . A File Download message displays.
3. Click **OK**.
4. Enter the location on your computer where you want to download the Callers List and click **SAVE**. The *callerlist.csv* file downloads to your computer.
5. Use a spreadsheet application to open and view the Callers List.

Account Configuration (DND and Call Forwarding)

The 6755i has a feature that allows you to configure “Do Not Disturb” (DND) and “call forwarding” (CFWD) for multiple accounts on the phone. You can set specific modes for the way you want the phone to handle DND and CFWD. The three modes you can set on the phone for these features are:

- Account
- Phone
- Custom

The following paragraphs describe account-based DND and CFWD:

- [DND Account-Based Configuration](#)
- [Call Forward Account-Based Configuration](#)

DND Account-Based Configuration

"Do Not Disturb" (DND) is a feature on the phone that prevents the phone from ringing and receiving incoming calls. When DND is enabled with "call forwarding" (CFWD), any incoming calls can be call forwarded to voicemail or another number. See "[Call Forward Account-Based Configuration](#)" on [page 193](#) for more information about call forwarding to other numbers.

On the 6755i, you can set DND on the phone-side for a specific account or for all accounts on the phone. You can set three modes for DND using the Aastra Web UI at the path, **Basic Settings->Preferences->General->DND Key Mode: Account, Phone (default), and Custom.** DND performs according to the mode you set.

You can then configure a DND key (for the phone or for an expansion module) using the Aastra Web UI at the path, **Operation->Softkeys Keys and XML or Operation->Programmable Keys.** You can enable and disable DND by toggling the key, or by setting DND for a specific account at the path, **Basic Settings->Account Configuration.** Once you enable DND, "DND" displays on the LCD for the applicable account.

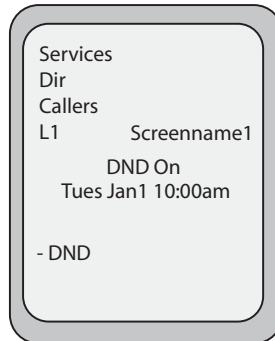



Note: If there is only one account configured on the phone, then the mode setting is ignored and the phone behaves as if the mode was set to “Phone”.

The following describes the key behavior for each DND mode.

- **Account** - DND key toggles the account in focus on the IP Phone UI, to ON or OFF if DND enabled for that account.
- **Phone** - (default) DND key toggles all accounts on the phone to ON or OFF.
- **Custom** - DND key displays custom screens on the IP Phone UI. User can select whether to enable/disable DND per account, enable DND on all accounts, or disable DND on all accounts.

The following table describes the key and Message Waiting Indicator (MWI) LEDs when you enable DND on the IP Phone.

Key LED Behavior for All Modes	MWI LED Behavior for All Modes
DND key LED RED if current account in focus has DND ON. DND key LED OFF when current account in focus has DND disabled.	MWI LED ON if current account in focus has DND ON. MWI LED OFF if current account in focus has DND OFF.



Note: If you make changes to the configuration for DND via the IP Phone UI, you must refresh the Aastra Web UI screen to see the changes.

Configuring DND

The following describes configuring DND on your phone. To configure a DND key, see the section, “["Do not Disturb" \(DND\) Key](#)” on [page 82](#).



Note: If there is no DND key configured or if it is removed, DND is disabled on the IP Phone.

Configuring DND Using the Aastra Web UI.

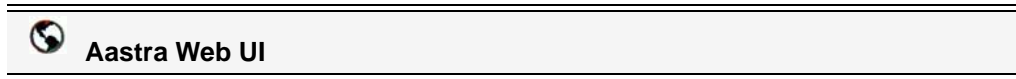

Use the following procedure to configure DND using the Aastra Web UI.

1. Click on **Basic Settings->Preferences->General**.

<p>Status</p> <ul style="list-style-type: none"> System Information <p>Operation</p> <ul style="list-style-type: none"> User Password Phone Lock Softkeys and XML Programmable Keys Keypad Speed Dial Directory Reset <p>Basic Settings</p> <ul style="list-style-type: none"> Preferences Account Configuration 	<p>Preferences</p> <p>General</p> <p>Park Call: <input type="text"/></p> <p>Pick Up Parked Call: <input type="text"/></p> <p>Suppress DTMF Playback <input checked="" type="checkbox"/> Enabled</p> <p>Display DTMF Digits <input type="checkbox"/> Enabled</p> <p>Call Waiting <input checked="" type="checkbox"/> Enabled</p> <p>Play Call Waiting Tone <input checked="" type="checkbox"/> Enabled</p> <p>Stuttered Dial Tone <input checked="" type="checkbox"/> Enabled</p> <p>XML Beep Support <input checked="" type="checkbox"/> Enabled</p> <p>Status Scroll Delay (seconds) <input type="text" value="5"/></p> <p>Incoming Call Interrupts Dialing <input type="checkbox"/> Enabled</p> <p>Switch UI Focus To Ringing Line <input checked="" type="checkbox"/> Enabled</p> <p>Preferred line <input type="text" value="1"/></p> <p>Preferred line Timeout (seconds) <input type="text" value="0"/></p> <p>Goodbye Key Cancels Incoming Call <input checked="" type="checkbox"/> Enabled</p> <p>UPnP Mapping Lines <input type="text" value="0"/></p> <p>Message Waiting Indicator Line <input type="text" value="All"/></p> <p>DND Key Mode <input type="text" value="Phone"/></p> <p>Call Forward Key Mode <input type="text" value="Account"/></p> <p>Use LLDP ELIN <input checked="" type="checkbox"/> Enabled</p>
---	---

2. In the “**DND Key Mode**” field, select a “do not disturb” (DND) mode to use on the phone. Valid values are: **Account**, **Phone** (default), **Custom**. Default is **Phone**.

- **account** Sets DND for a specific account. DND key toggles the account in focus on the phone to ON or OFF.
- **phone** (default) Sets DND ON for all accounts on the phone. DND key toggles all accounts on the phone to ON or OFF.
- **custom** Sets the phone to display custom screens after pressing the DND key, that list the account(s) on the phone. The user can select a specific account for DND, turn DND ON for all accounts, or turn DND OFF for all accounts.



Notes:

1. If there is only one account configured on the phone, then the mode setting is ignored and the phone behaves as if the mode was set to “Phone”.
2. Using the Aastra Web UI, if you change the DND Key Mode to “phone”, all accounts synchronize to the current setting of Account 1.

3. Click  to save your changes. The changes take effect immediately without a reboot.

4. Click on **Basic Settings->Account Configuration.**

Account	DND	Call Forward	State	Number	No. Rings
1.	<input type="checkbox"/>	All	<input type="checkbox"/>	<input type="text"/>	<input type="text"/>
		Busy	<input type="checkbox"/>	<input type="text"/>	<input type="text"/>
		No Answer	<input type="checkbox"/>	<input type="text"/>	1 ▾

Save Settings

5. For each account, enable DND by placing a check mark in the box. Disable DND by unchecking the box.



Notes:

1. If you selected “**Account**” or “**Custom**” mode in step 2, you can enable/disable each account or all accounts as applicable. If you selected “**Phone**” mode, the first account allows you to change the DND status for all accounts.

2. Number and name of accounts that display to this screen are dependant on the number and name of accounts configured on the phone. In the screen in step 4, Screenname1 is configured on Line 1, Screenname2 is configured on Line 2, and Screenname3 is configured on Line 3. Only your Administrator can create accounts for your phone. Contact your Administrator for more information.

6. Click  to save your changes. The changes takes affect immediately without a reboot.

Using DND Modes via the IP Phone UI

After you add a DND key to your phone, you can toggle the DND state using this key on the phone. Use the following procedure to enable/disable DND on the IP Phone.



IP Phone UI

The following procedures assume you have already configured a DND key AND assumes there are three accounts configured on the phone.



Notes:

1. If there is no DND key configured or if it is removed, DND is disabled on the IP Phone.

2. If there is only one account configured on the phone, then the mode setting is ignored and the phone behaves as if the mode was set to “Phone”.

3. Using the Aastra Web UI, if you change the DND key mode to “phone”, all accounts synchronize to the current setting of Account 1.

DND in Account Mode

1. With the account in focus on the IP Phone UI, press the DND key to toggle DND ON or OFF for the account. Use the RIGHT and LEFT arrow keys to scroll through each account.
2. Use the RIGHT and LEFT arrow keys to scroll through each account.

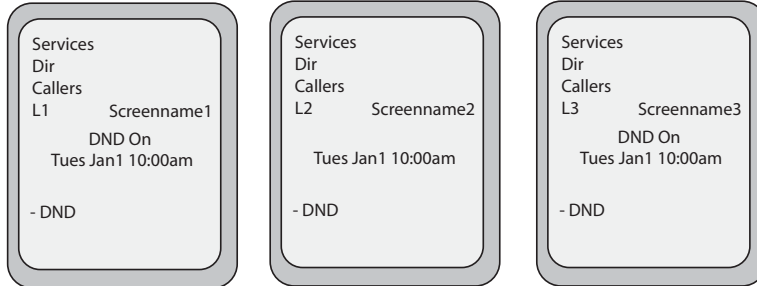

In the above example, Screenname1, Screenname2, and Screenname3, are three accounts configured on the phone. Only Screenname1 and 3 have DND ON. Screenname 2 has DND OFF.

DND in Phone Mode (Default)

1. Press the DND key to toggle DND ON or OFF for all accounts on the phone. Toggling to ON enables DND on all accounts on the phone. Toggling to OFF disables DND on all accounts on the phone. Use the RIGHT and LEFT arrow keys to scroll through each account. Use the RIGHT and LEFT arrow keys to scroll through each account.

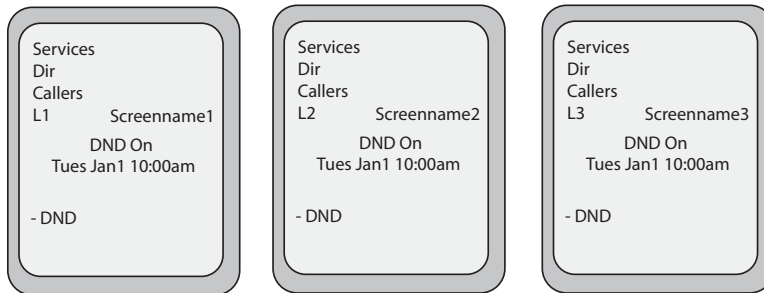

In the above example, toggling Screenname1 to DND ON, enabled DND for Screenname2 and 3 also.



Note: Enabling DND in “Phone” mode toggles all accounts on the phone to DND ON.

DND in Custom Mode

1. Press the **DND** key on the phone. The screen displays a list of the accounts on the phone and allows you to enable/disable a specific account or all accounts. Use the UP and DOWN arrow keys to scroll through the accounts.

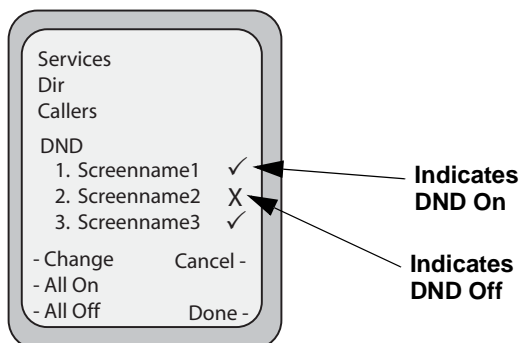

In the above example, Screenname1 and 3 have DND ON as indicated by a check mark (✓). Screenname2 has DND off as indicated by an X. The ALL ON and ALL OFF softkeys allow you to enable or disable DND on all accounts, respectively.

2. You use the **CHANGE** key to enable or disable DND for a specific account selected.
3. Press **DONE** to save the change.

Call Forward Account-Based Configuration

Call Forward (CFWD) on the IP phone allows incoming calls to be forwarded to another destination.

On the 6755i, you can set Call Forward (CFWD) on the phone-side for a specific account or for all accounts on the phone. You can set a CFWD mode using the Aastra Web UI at the path, **Basic Settings->Preferences->General->Call Forward Key Mode: Account** (default), **Phone**, and **Custom**. CFWD performs according to the mode you set.

You can configure CFWD using the Aastra Web UI at the path, **Basic Settings->Account Configuration**, **OR** you can configure CFWD using the IP Phone UI at the path, **Options->Call Forward**.

Using the Aastra Web UI at the path, **Operation->Softkeys and XML** or **Operation->Programmable Keys**, you can also configure a CFWD key for the phone (or for an expansion module) to use as a shortcut for accessing the CFWD menu on the phone.

The following describes the behavior for each CFWD mode.

- **Account** - (default) The account mode allows you to configure CFWD on a per account basis. Pressing a configured CFWD key applies to the account in focus.
- **Phone** - The Phone mode allows you to set the same CFWD configuration for all accounts (**All**, **Busy**, and/or **No Answer**). When you configure the initial account, the phone applies the configuration to all other accounts. (In the Aastra Web UI, only the account you configured is enabled. All other accounts are grayed out but set to the same configuration.) Using the Aastra Web UI, if you make changes to that initial account, the changes apply to all accounts on the phone.
- **Custom** - The Custom mode allows you to configure CFWD for a specific account or all accounts. You can configure a specific mode (**All**, **Busy**, and/or **No Answer**) for each account independently or all accounts. On the 6755i, you can set all accounts to **All On**, **All Off**, or copy the configuration for the account in focus to all other accounts using a **CopytoAll** softkey.



Note: If there is only one account configured on the phone, then the mode setting is ignored and the phone behaves as if the mode was set to “**Phone**”.

You can enable different CFWD rules/modes independently (for example, you can set different phone numbers for **Busy**, **All**, and **NoAnswer** modes and then turn them on/off individually).

The following table describes the key and Message Waiting Indicator (MWI) LEDs when you enable CFWD on the IP Phone.

Key LED Behavior for All Modes	MWI LED Behavior for All Modes
CFWD key LED RED if CFWD All, CFWD Busy, or CFWD No Answer is enabled for the account in focus. CFWD key LED OFF if any CFWD mode is disabled.	MWI LED ON if current account in focus has CFWD ALL enabled. MWI LED OFF if CFWD All is disabled.



Note: If you make changes to the configuration for CFWD via the IP Phone UI, you must refresh the Aastra Web UI screen to see the changes.

Configuring CFWD Using the Aastra Web UI



Aastra Web UI

Use the following procedure to configure CFWD using the Aastra Web UI.



Note: (Optional) You can configure a Call Forward key on your phone to access the Call Forward menus if desired. You can also access the Call Forward menu from the IP Phone UI at the path, *Options->Call Forward*.

1. (optional) Click on **Operation->Softkeys and XML**;
or
Click on **Operation->Programmable Keys**;
or
Click on **Operation->Expansion Module**.

Key	Type	Label	Value	Line	Idle	Connected	Incoming	Outgoing	Busy
1	Call Forward			1	<input checked="" type="checkbox"/>	<input checked="" type="checkbox"/>	<input checked="" type="checkbox"/>	<input checked="" type="checkbox"/>	<input checked="" type="checkbox"/>
2	None			1	<input checked="" type="checkbox"/>	<input checked="" type="checkbox"/>	<input checked="" type="checkbox"/>	<input checked="" type="checkbox"/>	<input checked="" type="checkbox"/>
3	None			1	<input checked="" type="checkbox"/>	<input checked="" type="checkbox"/>	<input checked="" type="checkbox"/>	<input checked="" type="checkbox"/>	<input checked="" type="checkbox"/>
4	None			1	<input checked="" type="checkbox"/>	<input checked="" type="checkbox"/>	<input checked="" type="checkbox"/>	<input checked="" type="checkbox"/>	<input checked="" type="checkbox"/>
5	None			1	<input checked="" type="checkbox"/>	<input checked="" type="checkbox"/>	<input checked="" type="checkbox"/>	<input checked="" type="checkbox"/>	<input checked="" type="checkbox"/>
6	None			1	<input checked="" type="checkbox"/>	<input checked="" type="checkbox"/>	<input checked="" type="checkbox"/>	<input checked="" type="checkbox"/>	<input checked="" type="checkbox"/>
7	None			1	<input checked="" type="checkbox"/>	<input checked="" type="checkbox"/>	<input checked="" type="checkbox"/>	<input checked="" type="checkbox"/>	<input checked="" type="checkbox"/>
8	None			1	<input checked="" type="checkbox"/>	<input checked="" type="checkbox"/>	<input checked="" type="checkbox"/>	<input checked="" type="checkbox"/>	<input checked="" type="checkbox"/>
9	None			1	<input checked="" type="checkbox"/>	<input checked="" type="checkbox"/>	<input checked="" type="checkbox"/>	<input checked="" type="checkbox"/>	<input checked="" type="checkbox"/>
10	None			1	<input checked="" type="checkbox"/>	<input checked="" type="checkbox"/>	<input checked="" type="checkbox"/>	<input checked="" type="checkbox"/>	<input checked="" type="checkbox"/>
11	None			1	<input checked="" type="checkbox"/>	<input checked="" type="checkbox"/>	<input checked="" type="checkbox"/>	<input checked="" type="checkbox"/>	<input checked="" type="checkbox"/>
12	None			1	<input checked="" type="checkbox"/>	<input checked="" type="checkbox"/>	<input checked="" type="checkbox"/>	<input checked="" type="checkbox"/>	<input checked="" type="checkbox"/>
13	None			1	<input checked="" type="checkbox"/>	<input checked="" type="checkbox"/>	<input checked="" type="checkbox"/>	<input checked="" type="checkbox"/>	<input checked="" type="checkbox"/>
14	None			1	<input checked="" type="checkbox"/>	<input checked="" type="checkbox"/>	<input checked="" type="checkbox"/>	<input checked="" type="checkbox"/>	<input checked="" type="checkbox"/>
15	None			1	<input checked="" type="checkbox"/>	<input checked="" type="checkbox"/>	<input checked="" type="checkbox"/>	<input checked="" type="checkbox"/>	<input checked="" type="checkbox"/>
16	None			1	<input checked="" type="checkbox"/>	<input checked="" type="checkbox"/>	<input checked="" type="checkbox"/>	<input checked="" type="checkbox"/>	<input checked="" type="checkbox"/>
17	None			1	<input checked="" type="checkbox"/>	<input checked="" type="checkbox"/>	<input checked="" type="checkbox"/>	<input checked="" type="checkbox"/>	<input checked="" type="checkbox"/>
18	None			1	<input checked="" type="checkbox"/>	<input checked="" type="checkbox"/>	<input checked="" type="checkbox"/>	<input checked="" type="checkbox"/>	<input checked="" type="checkbox"/>
19	None			1	<input checked="" type="checkbox"/>	<input checked="" type="checkbox"/>	<input checked="" type="checkbox"/>	<input checked="" type="checkbox"/>	<input checked="" type="checkbox"/>
20	None			1	<input checked="" type="checkbox"/>	<input checked="" type="checkbox"/>	<input checked="" type="checkbox"/>	<input checked="" type="checkbox"/>	<input checked="" type="checkbox"/>

Services

XML Application URI:

XML Application Title:

BLF List URI:

Softkey 1 configured for CFWD

Softkeys

2. Select from "Key 1" through "Key 20".
3. In the "Type" field, select **Call Forward** from the list of options.
4. (optional) If required, enable or disable the applicable states for the Call Forward key (Idle, Connected, Incoming, Outgoing, and/or Busy).

Programmable Keys

5. Select from "Key 1" through "Key 6"
6. In the "Type" field, select **Call Forward** from the list of options.

Expansion Module Keys

7. Select from "Key 1" through "Key 36" (M670i)
or
Select from "Key 1" through "Key 60" (M675i)
8. In the "Type" field, select **Call Forward** from the list of options.
9. Click  to save your changes.



Note: If there is no CFWD key configured on the phone or it is removed, you can still set the CFWD modes via the IP Phone UI at the path *Options->Call Forward*.

10. Click on **Basic Settings->Preferences->General**.

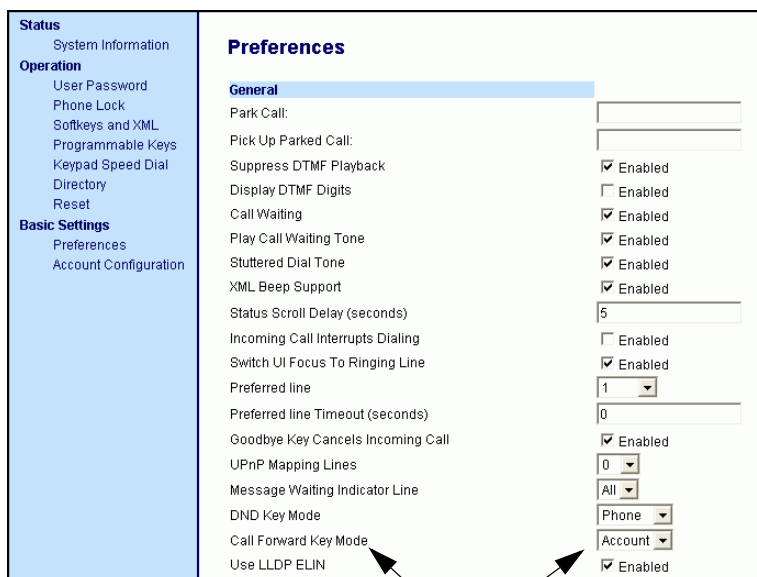

**Call Forward
Key Mode
Parameter**

11. In the "Call Forward Key Mode" field, select a call forward mode to use on the phone. Valid values are: Account, Phone, Custom. Default is **Account**.

- **Account** - (default) The account mode allows you to configure CFWD on a per account basis. Pressing a configured CFWD key applies to the account in focus.
- **Phone** - The Phone mode allows you to set the same CFWD configuration for all accounts (**All**, **Busy**, and/or **No Answer**). When you configure the initial account, the phone applies the configuration to all other accounts. (In the Aastra Web UI, only the account you configured is enabled. All other accounts are grayed out but set to the same configuration.) Using the Aastra Web UI, if you make changes to that initial account, the changes apply to all accounts on the phone.

- **Custom** - The Custom mode allows you to configure CFWD for a specific account or all accounts. You can configure a specific state (**All**, **Busy**, and/or **No Answer**) for each account independently or all accounts. On the 6755i, you can set all accounts to **All On**, **All Off**, or copy the configuration for the account in focus to all other accounts using a **CopytoAll** softkey.



Note: If there is only one account configured on the phone, then the mode setting is ignored and the phone behaves as if the mode was set to “Phone”.

12. Click  to save your changes.
The changes takes affect immediately without a reboot.
13. Click on **Basic Settings->Account Configuration**.

Account	DND	Call Forward	State	Number	No. Rings
1. Screenname1	<input type="checkbox"/>	All Busy No Answer	<input type="checkbox"/>	<input type="text"/> <input type="text"/> <input type="text"/>	1
2. Screenname2	<input type="checkbox"/>	All Busy No Answer	<input type="checkbox"/>	<input type="text"/> <input type="text"/> <input type="text"/>	1
3. Screenname3	<input type="checkbox"/>	All Busy No Answer	<input type="checkbox"/>	<input type="text"/> <input type="text"/> <input type="text"/>	1

Save Settings

The illustration above shows 3 accounts configured on the phone. Accounts must be set up by your System Administrator.

14. For each account, enable the CFWD state by placing a check mark in one or more of the following “**State**” fields:
 - All
 - Busy
 - No Answer

The “**All**” option forwards all incoming calls for this account to the specified phone number regardless of the state of the phone. The phone can be in the Busy or No Answer states, or can be in the idle state. The phone still forwards all calls to the specified number.

The “**Busy**” option call forwards incoming calls only if the account is in the busy state. The calls are forwarded to the specified phone number.

The “**No Answer**” option call forwards incoming calls only if the account rings but is not answered in the defined number of rings. The call gets forwarded to the specified number.



Note: You can use the “**Busy**” and “**No Answer**” states together using different forwarding phone numbers. If these states are enabled for an account (the “**All**” state is disabled), and the phone is in the busy state when a call comes in, the phone can forward the call to the specified phone number (for example, voicemail). If there is no answer on the phone after the specified number of rings, the phone can forward the call to a different specified number, such as a cell phone number.

- For each account, in the “**Number**” field, enter the phone number for which you want the incoming calls to forward to if the phone is in the specified state.

If using the “**Account**” mode or “**Custom**” mode, you can enter different phone numbers for each account.



Notes:

- If you selected “**Account**” mode in step 5, you can enable/disable each account or all accounts as applicable. You can enter different phone number for each enabled state.

If you selected “**Custom**” mode, you can enable/disable each account or all accounts as applicable. You can enter different phone numbers for each enabled state.

If you selected “**Phone**” mode, all accounts are set to the same CFWD configuration (All, Busy, and/or No Answer) as Account 1 on the phone. (In the Aastra Web UI, only Account 1 is enabled. All other accounts are grayed out but use the same configuration as Account 1.)

Using the Aastra Web UI, if you make changes to Account 1, the changes apply to all accounts on the phone. Using the IP Phone UI, if you make changes to any other account other than Account 1, the changes also apply to all accounts on the phone. When enabling a CFWD state, you must specify a phone number for the phone to CFWD to. The number you specify applies to all accounts of the same mode.

- Number and name of accounts that display to this screen are dependant on the number and name of accounts configured on the phone. In the screen in step 7, Screenname1 is configured on Line 1, Screenname2 is configured on Line 2, and Screenname3 is configured on Line 3. The name for the account is specified by your System Administrator. Contact your System Administrator for more information.

- For the “**No Answer**” state, in the “**No. Rings**” field, enter the number of times that the account rings before forwarding the call to the specified number. Valid values are 1 through 20. Default is 1.

When using the “**Account**” mode or “**Custom**” mode, you can enter a different number of rings for each account. If you use the Aastra Web UI to change the Call Forward Key Mode to “**Phone**”, all accounts synchronize to Account 1.

- Click  to save your changes.
The changes takes affect immediately without a reboot.

Using CFWD via the IP Phone UI

Once CFWD is enabled on your phone, you can access and change the configuration using the IP Phone UI or the Aastra Web UI. You can access the CFWD menus by pressing a pre-configured Call Forward key, or by selecting *Options->Call Forward* from the IP Phone UI.

The following procedure assumes you have already configured a CFWD key AND assumes there are three accounts configured on the phone.



Notes:

1. If there is no CFWD key configured on the phone or it is removed, you can still enable CFWD via the IP Phone UI at the path *Options->Call Forward*.
2. If there is only one account configured on the phone, then the mode setting is ignored and the phone behaves as if the mode was set to “Phone”.
3. Using the Aastra Web UI, if you change the CFWD key mode to “**Phone**”, all accounts synchronize to the current setting of Account 1.

CFWD in Account Mode

1. Use the **RIGHT** and **LEFT** arrow keys to scroll through each account.

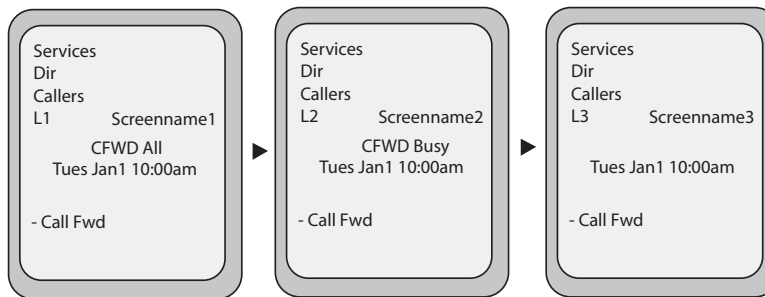

In the above example, Screenname1, Screenname2, and Screenname3, are three accounts configured on the phone. Screenname1 has “**CFWD All**” enabled, Screenname2 has “**CFWD Busy**” enabled, and Screenname3 has CFWD disabled as indicated by no message displayed.

2. Press the **Call Forward** key. The Call Forward Mode screen displays for the account you selected. Use the **UP** and **DOWN** arrow keys to scroll through each state type.

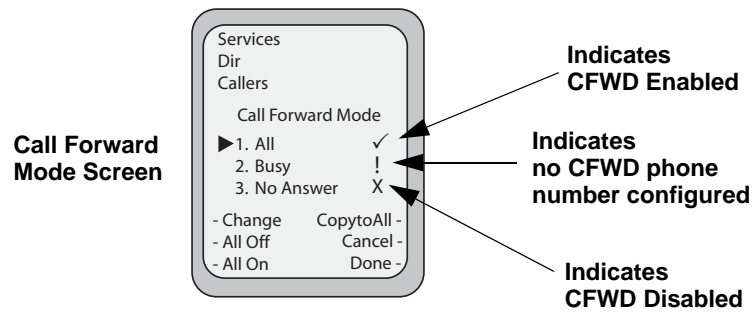

In the above example, **CFWD All** is enabled as indicated by a check mark (✓), **CFWD Busy** is enabled but no call forward phone number is configured as indicated by a !, and **CFWD NoAns** is disabled as indicated by an X.

3. Select a state for the account(s) in focus using the **UP** and **DOWN** arrow keys. You can enable/disable any or all of the following states for an account:

- **All** - Enables **CFWD All** for an account and forwards all incoming calls for that account, to the specified number.
- **Busy** - Enables **CFWD Busy** for an account and forwards incoming calls to a specified number if DND has been enabled for that account OR if the account is currently engaged in another call.
- **No Answer** - Enables **CFWD NoAns** for an account and forwards incoming calls to a specified number if the call has not been answered for the specified number of rings.



Note: If **CFWD All** AND **CFWD Busy** AND **CFWD NoAns** are all enabled (and/or if the account has DND enabled), the **CFWD All** settings take precedence over **CFWD Busy** and **CFWD NoAns**.

You can also use the following keys if required:

- **All Off** - Disables all CFWD states for the current account in focus.
- **All On** - Enables all CFWD states for the current account in focus.
- **CopytoAll Key** - Copies the call forward phone number and state of the Call Forward mode (All, Busy, No Answer) in focus to every Call Forward mode of that account. For example, if you have the cursor pointing at the “All” state and it is enabled and has a call forward phone number configured, pressing the **CopytoAll Key** enables the **Busy** state and the **NoAns** state and assigns the same phone number to both states.
- **Cancel Key** - Cancels any configuration you may have made without saving. To cancel a configuration, you must press this **CANCEL** key before pressing the **DONE** key.

- For the **CFWD No Answer** state, press the **CHANGE** key for the mode you selected in step 2. This displays the Call Forward State screen. In the following example, the **CFWD All** state is ON.

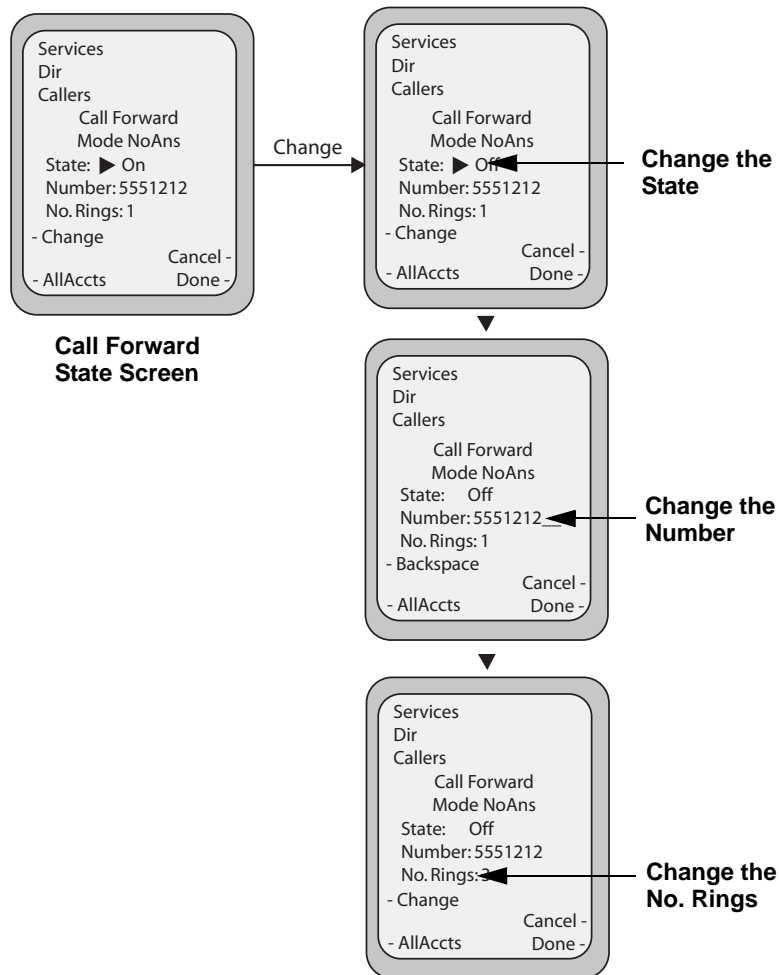

Note: You can press the **AllAccts** key to copy the settings in the current Call Forward Settings screen for a specific call forward mode, to every account on the phone. Every account will have the same settings for that call forward mode.

- Press the **CHANGE** key in the CFWD State screen. With the cursor in the “**State**” field, toggle the state ON and OFF by pressing the **CHANGE** key.
- Use the **DOWN** arrow key to scroll to the “**Number**” field. Enter a phone number to apply to the current state in focus. When the phone is in the state you specified, and a call comes into the phone, it forwards the call to the number you specify.

Use the **BACKSPACE** key if required to delete characters.

- Use the **DOWN** arrow key to scroll to the “**No. Rings**” field. Press the **CHANGE** key to select the number of rings to apply to the phone for call forwarding incoming calls. Valid values are 1 to 20. Default is 1.

When the phone receives an incoming call, and call forward is configured on the phone, the phone rings the number of times you specify in the No. Rings screen, and then forwards the call.

- Press **DONE** in the CFWD State Screen to save all changes.
- Press **DONE** in the CFWD Mode Screen to save all changes.

CFWD in Phone Mode

Use the **RIGHT** and **LEFT** arrow keys to scroll through each account.

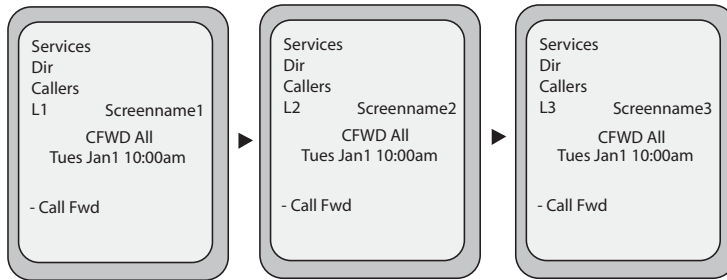

In the above example, Screenname1, Screenname2, and Screenname3, are three accounts configured on the phone. Screenname1, 2 and 3 have “**CFWD All**” enabled.



Note: In “Phone” mode, when you change the call forward configuration for an account, the change applies to all accounts.

- Press the **Call Forward** key. The Call Forward menu displays. Use the **UP** and **DOWN** arrow keys to scroll through each state type.

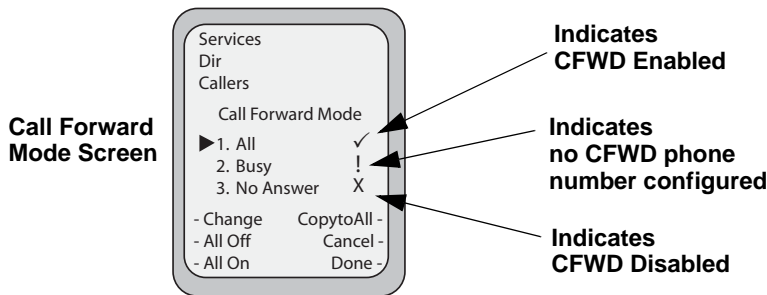

In the above example, **CFWD All** is enabled as indicated by a check mark (✓), **CFWD Busy** is enabled but no call forward phone number is configured as indicated by a !, and **CFWD No Answer** is disabled, as indicated by an X.

11. Select a state using the **UP** and **DOWN** arrow keys.

You can enable/disable a specific account on the phone with any or all of the following states. However, the configuration you set will apply to all accounts on the phone.

- **All** - Enables **CFWD All** on the phone and forwards all incoming calls to the specified number.
- **Busy** - Enables **CFWD Busy** on the phone and forwards incoming calls to a specified number if DND has been enabled OR if the phone is currently engaged in another call.
- **No Answer** - Enables **CFWD NoAns** on the phone and forwards incoming calls to a specified number if the call has not been answered for the specified number of rings.



Note: If **CFWD All** AND **CFWD Busy** AND **CFWD NoAns** are all enabled (and/or if the account has DND enabled), the **CFWD All** settings take precedence over **CFWD Busy** and **CFWD NoAns**.

You can also use the following keys if required:

- **All Off Key**- Disables all CFWD modes.
- **All On Key** - Disables all CFWD modes.
- **CopytoAll Key** - Copies the call forward phone number and state of the Call Forward mode (All, Busy, No Answer) in focus to every Call Forward mode. For example, if you have the cursor pointing at the “**All**” state and it is enabled and has a call forward phone number configured, pressing the **CopytoAll Key** enables the **Busy** state and the **NoAns** state and assigns the same phone number to both states.
- **Cancel Key** - Cancels any configuration you may have made without saving. To cancel a configuration, you must press this **CANCEL** key before pressing the **DONE** key.

12. In the **CFWD No Answer** state, press the **CHANGE** key for the mode you selected in step 2. This displays the Call Forward State screen. In the following example, the CFWD All state is ON.

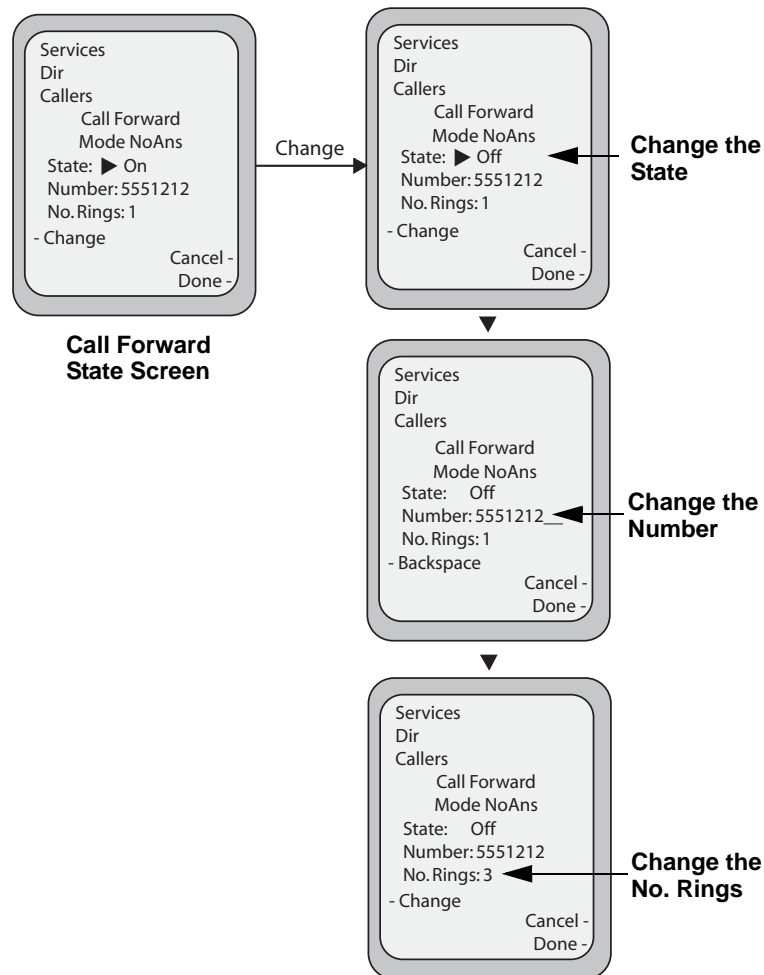

13. Press the **CHANGE** key in the CFWD State screen. With the cursor in the “**State**” field, toggle the state ON and OFF by pressing the **CHANGE** key.
14. Use the **DOWN** arrow key to scroll to the “**Number**” field. Enter a phone number to apply to the current state in focus. When the phone is in the state you specified, and a call comes into the phone, it forwards the call to the number you specify.
- Use the **BACKSPACE** key if required to delete characters.
15. Use the **DOWN** arrow key to scroll to the “**No. Rings**” field. Press the **CHANGE** key to select the number of rings to apply to the phone for call forwarding incoming calls. Valid values are **1** to **20**. Default is **1**.

When the phone receives an incoming call, and call forward is configured on the phone, the phone rings the number of times you specify in the No. Rings screen, and then forwards the call.

16. Press **DONE** in the CFWD State Screen to save all changes.

17. Press **DONE** in the CFWD Mode Screen to save all changes.



Note: In “Phone” mode, the configuration applies to all the accounts on the phone.

CFWD in Custom Mode

1. Use the **RIGHT** and **LEFT** arrow keys to scroll through each account.

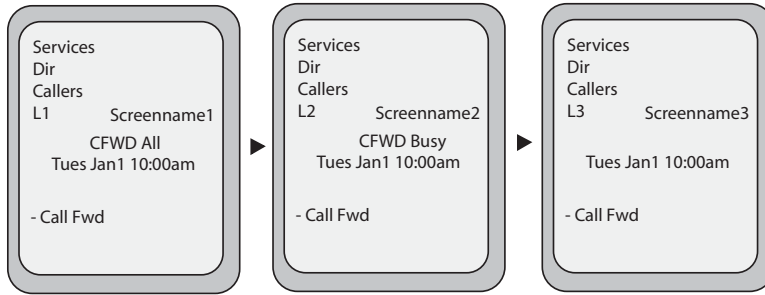

In the above example, Screenname1, Screenname2, and Screenname3, are three accounts configured on the phone. Screenname1 has “**CFWD All**” enabled, Screenname2 has “**CFWD Busy**” enabled, and Screenname3 has CFWD disabled as indicated by no message displayed.

2. With the account in focus on the IP Phone UI, press the **Call Forward** key. The Call Forward Account screen displays which lists all the accounts on the phone. Use the **UP** and **DOWN** arrow keys to scroll through each account.

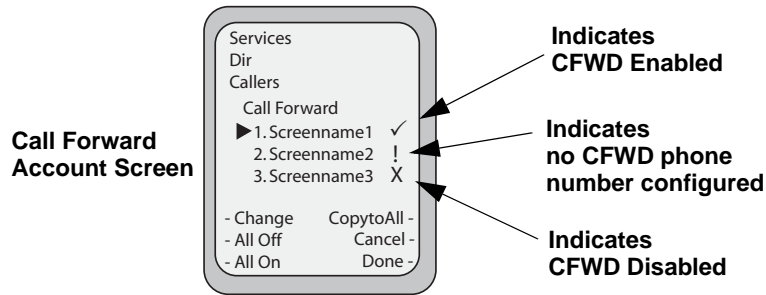

In the above example, Screenname1 has one or more CFWD states enabled as indicated by a check mark (✓), Screenname 2 has one or more CFWD states enabled but a specific state has no call forward phone number configured as indicated by a !, and Screenname3 has one or more CFWD states disabled as indicated by an X.

- Select an account using the **UP** and **DOWN** arrow keys.

You can also use the following keys if required:

- **All Off Key**- Disables CFWD for all accounts on the phone.
- **All On Key** - Enables CFWD for all accounts on the phone.
- **CopytoAll Key** - Copies all settings for the account you select, to all other accounts on the Call Forward Account screen. For example, if you have the cursor pointing at Screenname1, and you press the **CopytoAll** key, all of the CFWD settings for Screenname1 are copied to Screenname2 and Screenname3.
- **Cancel Key** - Cancels any configuration you may have made without saving. To cancel a configuration, you must press this **CANCEL** key before pressing the **DONE** key.

- After selecting an account, press **CHANGE**.

The Call Forward Mode screen displays for the account you selected. Use the **UP** and **DOWN** arrow keys to scroll through each state type.

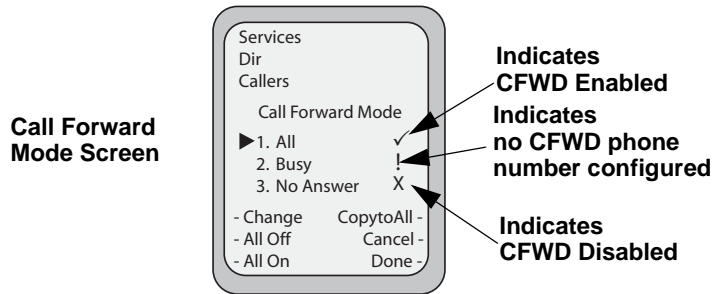

- In the above example, **CFWD All** is enabled as indicated by a check mark (✓), **CFWD Busy** is enabled but no call forward phone number is configured as indicated by a !, and **CFWD No Answer** is disabled, as indicated by an X.
- Select a state for the selected account(s) using the **UP** and **DOWN** arrow keys

You can enable/disable any or all of the following states for a specific account or for all accounts (with individual configurations):

- **All** - Enables **CFWD All** for an account and forwards all incoming calls for that account, to the specified number. The phone number can be different between accounts.
- **Busy** - Enables **CFWD Busy** for an account and forwards incoming calls to a specified number if DND has been enabled for that account OR if that account is currently engaged in another call. The phone number can be different between accounts.

No Answer - Enables **CFWD NoAns** for an account and forwards incoming calls to a specified number if the call has not been answered for a specified number of rings. The phone number can be different between accounts.

Note: If **CFWD All** AND **CFWD Busy** AND **CFWD NoAns** are all enabled (and/or if the account has DND enabled), the **CFWD All** settings take precedence over **CFWD Busy** and **CFWD NoAns**.

You can also use the following keys if required:

- **All Off Key**- Disables all CFWD states for the selected account.
 - **All On Key** - Enables all CFWD states for the selected account.
 - **CopytoAll Key** - Copies the call forward phone number and state of the selected Call Forward mode (All, Busy, No Answer) to every Call Forward mode of that account. For example, if you have the cursor pointing at the “All” state and it is enabled and has a call forward phone number configured, pressing the **CopytoAll Key** enables the **Busy** state and the **NoAns** state and assigns the same phone number to both states.
 - **Cancel Key** - Cancels any configuration you may have made without saving. To cancel a configuration, you must press this **CANCEL** key before pressing the **DONE** key.
7. Press the **CHANGE** key for the mode you selected in step 4. This displays the Call Forward State screen. In the following example, the CFWD All state is ON.

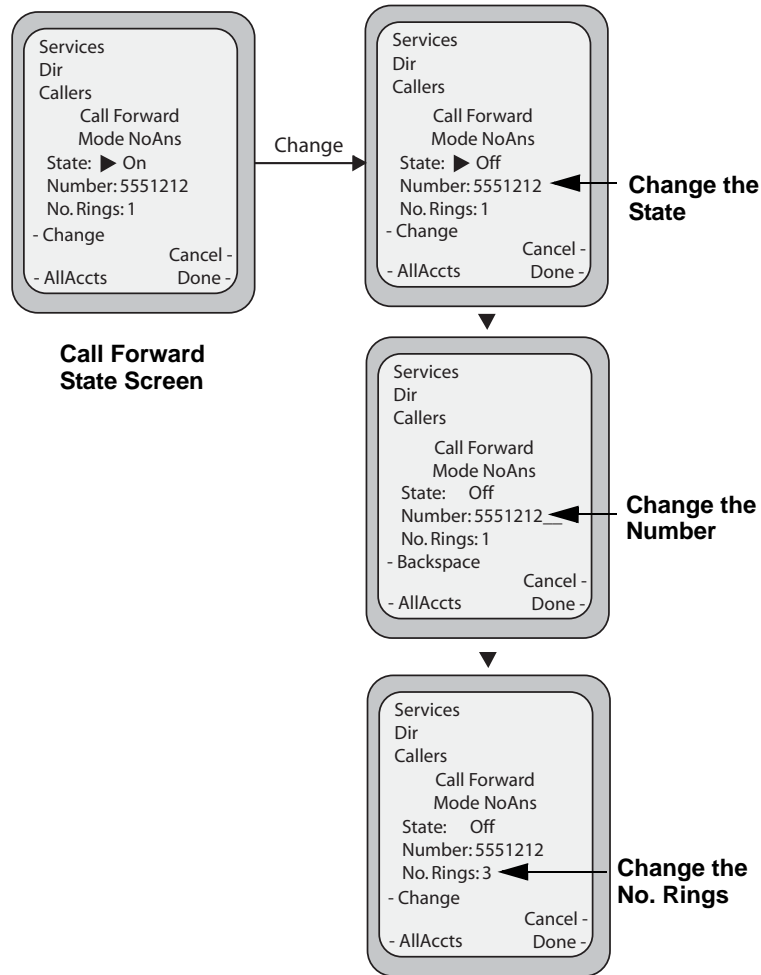

Note: You can press the **AllAccts** key to copy the settings in the current Call Forward Settings screen for a specific call forward mode, to every account on the phone. Every account will have the same settings for that call forward mode.

8. Press the **CHANGE** key in the CFWD State screen. With the cursor in the “State” field, toggle the state ON and OFF by pressing the **CHANGE** key.

9. Use the **DOWN** arrow key to scroll to the “**Number**” field. Enter a phone number to apply to the current state in focus. When the phone is in the state you specified, and a call comes into the phone, it forwards the call to the number you specify.

Use the **BACKSPACE** key if required to delete characters.

10. Use the **DOWN** arrow key to scroll to the “**No. Rings**” field. Press the **CHANGE** key to select the number of rings to apply to the phone for call forwarding incoming calls. Valid values are 1 to 20. Default is 1.

When the phone receives an incoming call, and call forward is configured on the phone, the phone rings the number of times you specify in the No. Rings screen, and then forwards the call.

11. Press **DONE** in the CFWD State screen to save all changes.
12. Press **DONE** in the CFWD Mode screen to save all changes.
13. Press **DONE** in the CFWD Account screen to save all changes.

Missed Calls Indicator

The IP phone has a "missed calls" indicator that increments the number of missed calls to the phone. This feature is accessible from the IP phone UI only.

The number of calls that have not been answered increment on the phone's idle screen as "**<number> New Calls**". As the number of unanswered calls increment, the phone numbers associated with the calls are stored in the Callers List. The user can access the Callers List and clear the call from the list. Once the user accesses the Callers List, the "**<number> New Calls**" on the idle screen is cleared.

Accessing and Clearing Missed Calls.



IP Phone UI

Use the following procedure to access and clear missed calls from the Callers List. Once you display the Callers List, the "**<number> New Calls**" indicator clears. Use the following illustration as a reference.

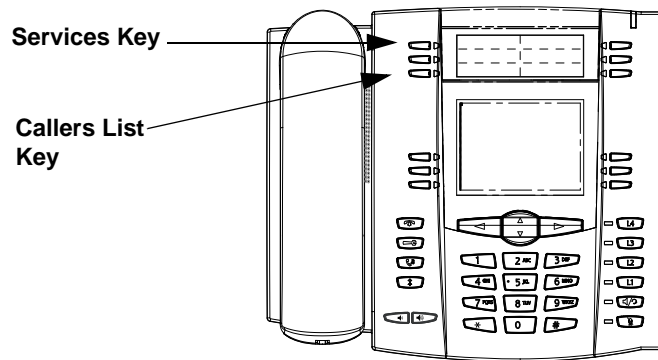

1. Press **Callers List** key on the phone.
or
Press the **Services** key and select **Callers List** from the menu.
2. Use the ▼ ▲ keys to scroll through the line items in the Callers List to find the line items that have the ☎ icon with the receiver ON. These are the missed calls to the phone.
3. To clear a line item from the Callers List, select the line item you want to delete and press the **Clear** softkey.

The line item is deleted from the Callers List.

Voicemail

The Voicemail feature on the 6755i IP phone allows you to use a line, configured with a phone number for dialing out, to connect to a voicemail server.

For each assigned Voicemail number, there can be a minimum of 0 or a maximum of 1 Voicemail access phone number.

The Voicemail list displays a list of phone numbers assigned to the 6755i that have registered voicemail accounts associated with them.



Note: The Voicemail list does not display the voicemail access number.

The phone displays up to 99 voicemail messages for an account even if the number of voicemails exceeds the limit.

Registered account numbers/URIs that exceed the length of the screen, either with or without the voicemail icon and the message count, are truncated with an ellipse character at the end of the number/URI string.

The end of the Voicemail list displays the number of new voicemail messages (if any exist).

Contact your System Administrator for lines configured for Voicemail.

Using Voicemail



IP Phone UI

1. Press the **Services** key on the phone.
2. Select "**Voicemail**".
3. Use the 2 and 5 keys to scroll through the line items in the Voicemail list.
4. When you have selected a line item, press the  handsfree key, 4 **Scroll Right** key, or press a line softkey to make an outgoing call using the voicemail access phone number associated with the line for which the voicemail account is registered.

From a selected item in the Voicemail list, you can also lift the handset (go offhook) to make an outgoing call using the voicemail access phone number.

Additional Features

This section describes additional features you can use on the 6755i phone.

Star Codes

All of the main call handling and extension management features using star codes can be set on your phone by your Administrator. Contact your System Administrator for more information.

If these have not been set up, you can dial any star code commands on the 6755i phone the same way you would on a regular telephone.

Suppress DTMF Playback

A feature on the IP phones allows you to enable or disable the suppression of DTMF playback when a number is dialed from the softkeys.

When suppression of DTMF playback is disabled, and you press a softkey, the IP phone dials the stored number and displays each digit as dialed in the LCD window.

When the suppression of DTMF playback is enabled, the IP phone dials the stored number and displays the entire number immediately in the LCD window, allowing the call to be dialed faster.

DTMF playback suppression is enabled by default. Disabling suppression of DTMF playback can be configured using the Aastra Web UI.

Configuring Suppression of DTMF Playback



Aastra Web UI

Use the following procedure to configure suppression of DTMF playback.



Note: "Suppress DTMF Playback" is enabled by default.

1. Click on **Basic Settings->Preferences.**

<p>Status</p> <ul style="list-style-type: none"> System Information <p>Operation</p> <ul style="list-style-type: none"> User Password Phone Lock Softkeys and XML Programmable Keys Keypad Speed Dial Directory Reset <p>Basic Settings</p> <ul style="list-style-type: none"> Preferences Account Configuration 	<p>Preferences</p> <p>General</p> <p>Park Call: <input type="text"/></p> <p>Pick Up Parked Call: <input type="text"/></p> <p>Suppress DTMF Playback <input checked="" type="checkbox"/> Enabled</p> <p>Display DTMF Digits <input type="checkbox"/> Enabled</p> <p>Call Waiting <input checked="" type="checkbox"/> Enabled</p> <p>Play Call Waiting Tone <input checked="" type="checkbox"/> Enabled</p> <p>Stuttered Dial Tone <input checked="" type="checkbox"/> Enabled</p> <p>XML Beep Support <input checked="" type="checkbox"/> Enabled</p> <p>Status Scroll Delay (seconds) <input type="text" value="5"/></p> <p>Incoming Call Interrupts Dialing <input type="checkbox"/> Enabled</p> <p>Switch UI Focus To Ringing Line <input checked="" type="checkbox"/> Enabled</p> <p>Preferred line <input type="text" value="1"/></p> <p>Preferred line Timeout (seconds) <input type="text" value="0"/></p> <p>Goodbye Key Cancels Incoming Call <input checked="" type="checkbox"/> Enabled</p> <p>UPnP Mapping Lines <input type="text" value="0"/></p> <p>Message Waiting Indicator Line <input type="text" value="All"/></p> <p>DND Key Mode <input type="text" value="Phone"/></p> <p>Call Forward Key Mode <input type="text" value="Account"/></p> <p>Use LLDP ELIN <input checked="" type="checkbox"/> Enabled</p>
---	---

2. Go to the "**General**" section.
3. The "**Suppress DTMF Playback**" field is enabled by default. To disable this field, uncheck the box.
4. Click to save your settings.

Display DTMF Digits

A feature on the 6755i phone allows users to enable or disable DTMF (dual-tone multi-frequency) digits to display to the IP phone when using the keypad to dial, or when dialing from a softkey, programmable key, or expansion module key.

DTMF is the signal sent from the phone to the network that you generate when you press the phone's touch keys. This is also known as "touchtone" dialing. Each key you press on your phone generates two tones of specific frequencies. One tone is generated from a high-frequency group of tones and the other from a low frequency group.

If you enable the Display DTMF Digits parameter, the digits you are dialing from the keypad, softkey, or programmable key, display to the IP phone's LCD display. This parameter is disabled by default (no digits display when dialing).

You can enable the "Display DTMF Digits" parameter using the Aastra Web UI.

Configuring Display of DTMF Digits



Aastra Web UI

Use the following procedure to configure the display of DTMF digits on the IP phone.



Note: "Display DTMF Digits" is disabled by default.

1. Click on **Basic Settings->Preferences->General**.

Status System Information	Preferences
Operation User Password Phone Lock Softkeys and XML Programmable Keys Keypad Speed Dial Directory Reset	General
Basic Settings Preferences Account Configuration	Park Call: <input type="text"/>
	Pick Up Parked Call: <input type="text"/>
	Suppress DTMF Playback <input checked="" type="checkbox"/> Enabled
	Display DTMF Digits <input type="checkbox"/> Enabled
	Call Waiting <input checked="" type="checkbox"/> Enabled
	Play Call Waiting Tone <input checked="" type="checkbox"/> Enabled
	Stuttered Dial Tone <input checked="" type="checkbox"/> Enabled
	XML Beep Support <input checked="" type="checkbox"/> Enabled
	Status Scroll Delay (seconds) <input type="text" value="5"/>
	Incoming Call Interrupts Dialing <input type="checkbox"/> Enabled
	Switch UI Focus To Ringing Line <input checked="" type="checkbox"/> Enabled
	Preferred line <input type="text" value="1"/>
	Preferred line Timeout (seconds) <input type="text" value="0"/>
	Goodbye Key Cancels Incoming Call <input checked="" type="checkbox"/> Enabled
	UPnP Mapping Lines <input type="text" value="0"/>
	Message Waiting Indicator Line <input type="text" value="All"/>
	DND Key Mode <input type="text" value="Phone"/>
	Call Forward Key Mode <input type="text" value="Account"/>
	Use LLDP ELIN <input checked="" type="checkbox"/> Enabled

2. Enable the "**Display DTMF Digits**" field by checking the check box. Disable this field by unchecking the box). Default is disabled.
3. Click  to save your settings.

Enable/Disable Call Waiting

The call waiting feature notifies the user on an active call, of a new incoming call. You can disable the call waiting feature, so that the new incoming call is automatically rejected by the phone with a busy message.

If you disable call waiting on the phone, and the user is on a call, any further incoming calls receive busy unless “**Call Forward Busy**” or “**Call Forward No Answer and Busy**” is configured on the phone (for information on “**Call Forward Account-Based Configuration**”, see [page 193](#).) It then forwards the call according to the rule configured. The phone can only:

- transfer the currently active call
- or
- accept transferred calls if there is no active calls.

If call waiting is disabled:

- intercom calls are treated as regular incoming calls and are rejected.
- pre-dialing with live dial pad disabled still accepts incoming calls.
- the “Incoming Call Interrupts Dialing” parameter is ignored because the incoming call is automatically rejected (for information on “**Incoming Call Interrupts Dialing**” see [page 221](#)).
- the Missed Calls List does not get updated with details of calls.
- the Blind Transfer feature on the phone may not work if two calls are made to the phone at one time.

You can disable call waiting using the configuration files or the Aastra Web UI.

Enabling/Disabling Call Waiting



Aastra Web UI

Use the following procedure to enable or disable Call Waiting on the IP phone.



Note: “Call Waiting” is enabled by default.

1. Click on **Basic Settings->Preferences->General.**

<p>Status</p> <ul style="list-style-type: none"> System Information <p>Operation</p> <ul style="list-style-type: none"> User Password Phone Lock Softkeys and XML Programmable Keys Keypad Speed Dial Directory Reset <p>Basic Settings</p> <ul style="list-style-type: none"> Preferences Account Configuration 	<p>Preferences</p> <p>General</p> <p>Park Call: <input type="text"/></p> <p>Pick Up Parked Call: <input type="text"/></p> <p>Suppress DTMF Playback <input checked="" type="checkbox"/> Enabled</p> <p>Display DTMF Digits <input type="checkbox"/> Enabled</p> <p>Call Waiting <input checked="" type="checkbox"/> Enabled</p> <p>Play Call Waiting Tone <input checked="" type="checkbox"/> Enabled</p> <p>Stuttered Dial Tone <input checked="" type="checkbox"/> Enabled</p> <p>XML Beep Support <input checked="" type="checkbox"/> Enabled</p> <p>Status Scroll Delay (seconds) <input type="text" value="5"/></p> <p>Incoming Call Interrupts Dialing <input type="checkbox"/> Enabled</p> <p>Switch UI Focus To Ringing Line <input checked="" type="checkbox"/> Enabled</p> <p>Preferred line <input type="text" value="1"/></p> <p>Preferred line Timeout (seconds) <input type="text" value="0"/></p> <p>Goodbye Key Cancels Incoming Call <input checked="" type="checkbox"/> Enabled</p> <p>UPnP Mapping Lines <input type="text" value="0"/></p> <p>Message Waiting Indicator Line <input type="text" value="All"/></p> <p>DND Key Mode <input type="text" value="Phone"/></p> <p>Call Forward Key Mode <input type="text" value="Account"/></p> <p>Use LLDP ELIN <input checked="" type="checkbox"/> Enabled</p>
---	---

2. The “**Call Waiting**” field is enabled by default. To disable this field, uncheck the box.
3. Click to save your settings.

Play Call Waiting Tone

You can enable or disable the playing of a call waiting tone when a caller is on an active call and a new call comes into the phone.

You can configure this feature using the Aastra Web UI.

Configuring Call Waiting Tone



Aastra Web UI

Use the following procedures to configure a call waiting tone on the IP phone.



Note: "Play Call Waiting Tone" is enabled by default.

1. Click on **Basic Settings->Preferences->General**.

Status	Preferences
System Information	
Operation	General
User Password	Park Call: <input type="text"/>
Phone Lock	Pick Up Parked Call: <input type="text"/>
Softkeys and XML	Suppress DTMF Playback <input checked="" type="checkbox"/> Enabled
Programmable Keys	Display DTMF Digits <input type="checkbox"/> Enabled
Keypad Speed Dial	Call Waiting <input checked="" type="checkbox"/> Enabled
Directory	Play Call Waiting Tone <input checked="" type="checkbox"/> Enabled
Reset	Stuttered Dial Tone <input checked="" type="checkbox"/> Enabled
Basic Settings	XML Beep Support <input checked="" type="checkbox"/> Enabled
Preferences	Status Scroll Delay (seconds) <input type="text" value="5"/>
Account Configuration	Incoming Call Interrupts Dialing <input type="checkbox"/> Enabled
	Switch UI Focus To Ringing Line <input checked="" type="checkbox"/> Enabled
	Preferred line <input type="text" value="1"/>
	Preferred line Timeout (seconds) <input type="text" value="0"/>
	Goodbye Key Cancels Incoming Call <input checked="" type="checkbox"/> Enabled
	UPnP Mapping Lines <input type="text" value="0"/>
	Message Waiting Indicator Line <input type="text" value="All"/>
	DND Key Mode <input type="text" value="Phone"/>
	Call Forward Key Mode <input type="text" value="Account"/>
	Use LLDP ELIN <input checked="" type="checkbox"/> Enabled

2. The “**Play Call Waiting Tone**” field is enabled by default. To disable this field, uncheck the box.
3. Click  to save your settings.

Stuttered Dial Tone

You can enable or disable the playing of a stuttered dial tone when there is a message waiting on the IP phone.

You can configure this feature using the Aastra Web UI.

Configuring Stuttered Dial Tone



Aastra Web UI

Use the following procedures to configure stuttered dial tone on the IP phone.



Note: "Stuttered Dial Tone" is enabled by default.

1. Click on **Basic Settings->Preferences->General**.

<p>Status</p> <ul style="list-style-type: none"> System Information <p>Operation</p> <ul style="list-style-type: none"> User Password Phone Lock Softkeys and XML Programmable Keys Keypad Speed Dial Directory Reset <p>Basic Settings</p> <ul style="list-style-type: none"> Preferences Account Configuration 	<p>Preferences</p> <p>General</p> <p>Park Call: <input type="text"/></p> <p>Pick Up Parked Call: <input type="text"/></p> <p>Suppress DTMF Playback <input checked="" type="checkbox"/> Enabled</p> <p>Display DTMF Digits <input type="checkbox"/> Enabled</p> <p>Call Waiting <input checked="" type="checkbox"/> Enabled</p> <p>Play Call Waiting Tone <input checked="" type="checkbox"/> Enabled</p> <p>Stuttered Dial Tone <input checked="" type="checkbox"/> Enabled</p> <p>XML Beep Support <input checked="" type="checkbox"/> Enabled</p> <p>Status Scroll Delay (seconds) <input type="text" value="5"/></p> <p>Incoming Call Interrupts Dialing <input type="checkbox"/> Enabled</p> <p>Switch UI Focus To Ringing Line <input checked="" type="checkbox"/> Enabled</p> <p>Preferred line <input type="text" value="1"/></p> <p>Preferred line Timeout (seconds) <input type="text" value="0"/></p> <p>Goodbye Key Cancels Incoming Call <input checked="" type="checkbox"/> Enabled</p> <p>UPnP Mapping Lines <input type="text" value="0"/></p> <p>Message Waiting Indicator Line <input type="text" value="All"/></p> <p>DND Key Mode <input type="text" value="Phone"/></p> <p>Call Forward Key Mode <input type="text" value="Account"/></p> <p>Use LLDP ELIN <input checked="" type="checkbox"/> Enabled</p>
---	---

2. The “**Stuttered Dial Tone**” field is enabled by default. To disable this field, uncheck the box.
3. Click  to save your settings.

XML Beep Support

Using the Aastra Web UI, you can enable or disable a beep to be audible when the phone receives an XML application using the "**XML Beep Support**" field at the path *Basic Settings->Preferences->General*. If you disable this feature, then no beep is heard when the XML application arrives to the phone.

If your System Administrator has set a value for this feature in a custom XML application or in the configuration files, the value you set in the Aastra Web UI overrides the Administrator's setting. Setting and saving the value in the Aastra Web UI applies to the phone immediately.

Configuring XML Beep Support



Aastra Web UI

Use the following procedures to configure an XML beep on the IP phone.



Note: "XML Beep Support" is enabled by default.

1. Click on **Basic Settings->Preferences->General**.

Status	Preferences
System Information	
Operation	General
User Password	Park Call: <input type="text"/>
Phone Lock	Pick Up Parked Call: <input type="text"/>
Softkeys and XML	Suppress DTMF Playback <input checked="" type="checkbox"/> Enabled
Programmable Keys	Display DTMF Digits <input type="checkbox"/> Enabled
Keypad Speed Dial	Call Waiting <input checked="" type="checkbox"/> Enabled
Directory	Play Call Waiting Tone <input checked="" type="checkbox"/> Enabled
Reset	Stuttered Dial Tone <input checked="" type="checkbox"/> Enabled
Basic Settings	XML Beep Support <input checked="" type="checkbox"/> Enabled
Preferences	Status Scroll Delay (seconds) <input type="text" value="5"/>
Account Configuration	Incoming Call Interrupts Dialing <input type="checkbox"/> Enabled
	Switch UI Focus To Ringing Line <input checked="" type="checkbox"/> Enabled
	Preferred line <input type="text" value="1"/>
	Preferred line Timeout (seconds) <input type="text" value="0"/>
	Goodbye Key Cancels Incoming Call <input checked="" type="checkbox"/> Enabled
	UPnP Mapping Lines <input type="text" value="0"/>
	Message Waiting Indicator Line <input type="text" value="All"/>
	DND Key Mode <input type="text" value="Phone"/>
	Call Forward Key Mode <input type="text" value="Account"/>
	Use LLDP ELIN <input checked="" type="checkbox"/> Enabled

2. The "**XML Beep Support**" field is enabled by default. To disable this field, uncheck the box.
3. Click  to save your settings.

Status Scroll Delay

Using the Aastra Web UI, you can specify a scroll delay option that allows you to set the time delay, in seconds, between the scrolling of each status message on the phone. You can specify this setting in the "**Status Scroll Delay (seconds)**" field at the path *Basic Settings->Preferences->General*. The default time is 5 seconds for each message to display before scrolling to the next message. You can increase or decrease this time as required. Setting and saving the value in the Aastra Web UI applies to the phone immediately.

Configuring Status Scroll Delay



Aastra Web UI

Use the following procedures to specify a status scroll delay on the IP phone.

1. Click on **Basic Settings->Preferences->General**.

<p>Status</p> <ul style="list-style-type: none"> System Information <p>Operation</p> <ul style="list-style-type: none"> User Password Phone Lock Softkeys and XML Programmable Keys Keypad Speed Dial Directory Reset <p>Basic Settings</p> <ul style="list-style-type: none"> Preferences Account Configuration 	<p>Preferences</p> <p>General</p> <p>Park Call: <input type="text"/></p> <p>Pick Up Parked Call: <input type="text"/></p> <p>Suppress DTMF Playback <input checked="" type="checkbox"/> Enabled</p> <p>Display DTMF Digits <input type="checkbox"/> Enabled</p> <p>Call Waiting <input checked="" type="checkbox"/> Enabled</p> <p>Play Call Waiting Tone <input checked="" type="checkbox"/> Enabled</p> <p>Stuttered Dial Tone <input checked="" type="checkbox"/> Enabled</p> <p>XML Beep Support <input checked="" type="checkbox"/> Enabled</p> <p>Status Scroll Delay (seconds) <input type="text" value="5"/></p> <p>Incoming Call Interrupts Dialing <input type="checkbox"/> Enabled</p> <p>Switch UI Focus To Ringing Line <input checked="" type="checkbox"/> Enabled</p> <p>Preferred line <input type="text" value="1"/></p> <p>Preferred line Timeout (seconds) <input type="text" value="0"/></p> <p>Goodbye Key Cancels Incoming Call <input checked="" type="checkbox"/> Enabled</p> <p>UPnP Mapping Lines <input type="text" value="0"/></p> <p>Message Waiting Indicator Line <input type="text" value="All"/></p> <p>DND Key Mode <input type="text" value="Phone"/></p> <p>Call Forward Key Mode <input type="text" value="Account"/></p> <p>Use LLDP ELIN <input checked="" type="checkbox"/> Enabled</p>
---	---

2. Enter a value in the "**Status Scroll Delay (seconds)**" field. Valid values are: 1 to 25 seconds. Default is 5 seconds.
3. Click to save your settings.

Incoming Call Interrupts Dialing

The 6755i has a feature you can enable or disable called "**Incoming Call Interrupts Dialing**". This feature is disabled by default. If you are dialing out on your phone, and you receive an incoming call at the same time, the incoming call goes to an available line and the LED blinks to let you know where the call was placed by the phone. If there is no line available to take the call, a busy signal is sent to the caller. The LCD continues to display the number you were dialing.

If "**Incoming Call Interrupts Dialing**" is enabled, the incoming call interrupts your dialing sequence and displays to the phone's LCD for you to answer. You have a choice to ignore the incoming call. If you choose to answer the incoming call, you can answer the call, finish the call, and then hang up. You can still go back to the original outgoing call and finish dialing out.

You can enable or disable this parameter in the Aastra Web UI at the path *Basic Settings->Preferences->General*.



Notes:

1. On a 6755i, you can press "**Ignore**" to ignore the call. To answer the call, you can press "**Answer**", lift the handset, or press the Speaker Key.
 2. If you disable this field, and the phone receives an incoming call while you are dialing an outgoing call, you can pick up the call and perform transfer or conference as required.
-

Transfer/Conference Call Behavior

If you are dialing the phone to transfer or conference a call, and your phone receives an incoming call, your dialing is never interrupted (regardless of whether the "**Incoming Call Interrupts Dialing**" is enabled or disabled). For Transfer and Conference, the incoming calls always go to an available line (other than the one you are using for dialing) and the incoming call's line LED blinks. The LCD still displays your dialing screen.

Intercom Behavior

If "**Incoming Call Interrupts Dialing**" is enabled and you are dialing an outgoing Intercom call, the enabled interrupt setting takes precedence over an enabled "**Allow Barge In**" setting. The incoming call interrupts your dialing on an outgoing intercom call. On an incoming intercom call, the enabled "**Allow Barge In**" and "**Auto-Answer**" occurs while you are dialing to transfer or conference the call. However, the incoming call goes to an available idle line, and the LED blinks while you are dialing the second half of the conference or transfer.

If "**Incoming Call Interrupts Dialing**" is disabled, an incoming intercom goes to an available idle line and the LED blinks for that line. The phone answers the call under all conditions.

Configuring "Incoming Call Interrupts Dialing"



Aastra Web UI

Use the following procedures to configure "Incoming Call Interrupts Dialing" on the IP Phone.



Note: "Incoming Call Interrupts Dialing" is disabled by default.

1. Click on **Basic Settings->Preferences->General.**

<p>Status System Information</p> <p>Operation User Password Phone Lock Softkeys and XML Programmable Keys Keypad Speed Dial Directory Reset</p> <p>Basic Settings Preferences Account Configuration</p>	<p>Preferences</p> <p>General</p> <p>Park Call: <input type="text"/></p> <p>Pick Up Parked Call: <input type="text"/></p> <p>Suppress DTMF Playback <input checked="" type="checkbox"/> Enabled</p> <p>Display DTMF Digits <input type="checkbox"/> Enabled</p> <p>Call Waiting <input checked="" type="checkbox"/> Enabled</p> <p>Play Call Waiting Tone <input checked="" type="checkbox"/> Enabled</p> <p>Stuttered Dial Tone <input checked="" type="checkbox"/> Enabled</p> <p>XML Beep Support <input checked="" type="checkbox"/> Enabled</p> <p>Status Scroll Delay (seconds) <input type="text" value="5"/></p> <p>Incoming Call Interrupts Dialing <input type="checkbox"/> Enabled</p> <p>Switch UI Focus To Ringing Line <input checked="" type="checkbox"/> Enabled</p> <p>Preferred line <input type="text" value="1"/></p> <p>Preferred line Timeout (seconds) <input type="text" value="0"/></p> <p>Goodbye Key Cancels Incoming Call <input checked="" type="checkbox"/> Enabled</p> <p>UPnP Mapping Lines <input type="text" value="0"/></p> <p>Message Waiting Indicator Line <input type="text" value="All"/></p> <p>DND Key Mode <input type="text" value="Phone"/></p> <p>Call Forward Key Mode <input type="text" value="Account"/></p> <p>Use LLDP ELIN <input checked="" type="checkbox"/> Enabled</p>
--	---

2. Enable the "Incoming Call Interrupts Dialing" field by checking the check box. Disable this field by unchecking the box). Default is disabled.
3. Click  to save your settings.

Switch UI Focus to Ringing Line

You can configure a feature on the 6755i that controls the behavior of the phone when it receives an incoming call when it is already in a connected call. When a call comes into the phone, and the phone is already on a connected call, the phone switches focus to the ringing line to enable the user to see who is calling them. You can turn off this functionality so that the phone stays focused on the connected call. You can do this using the Switch Focus to Ringing Line parameter in the Aastra Web UI.

Configuring “Switch Focus to Ringing Line” Using the Aastra Web UI



Aastra Web UI

Use the following procedure to enable or disable the “Switch Focus to Ringing Line” using the Aastra Web UI.



Note: "Switch Focus to Ringing Line" is enabled by default.

1. Click on **Basic Settings->Preferences->General.**

Status System Information	Preferences
Operation User Password Phone Lock Softkeys and XML Programmable Keys Keypad Speed Dial Directory Reset	General
Basic Settings Preferences Account Configuration	Park Call: <input type="text"/>
	Pick Up Parked Call: <input type="text"/>
	Suppress DTMF Playback <input checked="" type="checkbox"/> Enabled
	Display DTMF Digits <input type="checkbox"/> Enabled
	Call Waiting <input checked="" type="checkbox"/> Enabled
	Play Call Waiting Tone <input checked="" type="checkbox"/> Enabled
	Stuttered Dial Tone <input checked="" type="checkbox"/> Enabled
	XML Beep Support <input checked="" type="checkbox"/> Enabled
	Status Scroll Delay (seconds) <input type="text" value="5"/>
	Incoming Call Interrupts Dialing <input type="checkbox"/> Enabled
	Switch UI Focus To Ringing Line <input checked="" type="checkbox"/> Enabled
	Preferred line <input type="text" value="1"/>
	Preferred line Timeout (seconds) <input type="text" value="0"/>
	Goodbye Key Cancels Incoming Call <input checked="" type="checkbox"/> Enabled
	UPnP Mapping Lines <input type="text" value="0"/>
	Message Waiting Indicator Line <input type="text" value="All"/>
	DND Key Mode <input type="text" value="Phone"/>
	Call Forward Key Mode <input type="text" value="Account"/>
	Use LLDP ELIN <input checked="" type="checkbox"/> Enabled

2. The “**Switch Focus to Ringing Line**” field is enabled by default. To disable this field, uncheck the box.
3. Click  to save your settings.

Preferred Line and Preferred Line Timeout

The 6755i has a feature called “preferred line” and “preferred line timeout”. If you enable the preferred line parameter on your phone, after a call ends (incoming or outgoing), the display switches back to the preferred line. Next time you go off-hook to make another call, you pickup on the preferred line. You can enable the **preferred line** parameter using the Aastra Web UI at the location, *Basic Settings->Preferences->General*. You can also set a **preferred timeout** parameter that specifies the number of seconds it takes for the phone to switch back to the preferred line.



Note: You can configure “Preferred Line” and “Preferred Line Timeout” using the Aastra Web UI only.

The following table provides the behavior of the preferred line focus feature with other features on the phone.

Phone Feature	Preferred Line Behavior
call return	The phone switches back to the focused line immediately after the call ends.
speeddial	The line is already specified when the speeddial is created. The phone switches back immediately after the call ends.
conference	For incoming calls, the phone switches back immediately after the call ends.
transfer	For incoming or outgoing calls, the current behavior is that the same line used to transfer the call does not change. For incoming calls, the phone switches back immediately after the call transfers.
blf	The phone switches back immediately after the call ends.
park	The phone switches back immediately after the call ends.
voicemail	The phone switches back immediately after the call ends.
redial	The phone switches back immediately after the call ends.
dialing	For incomplete dialing on a non-preferred line, the focus does not change if some digits are entered. If no digits are entered or digits were cleared, the focus changes to preferred line after the time out has passed without activities.
caller id	If the "Switch UI Focus To Ringing Line" parameter is disabled, the User is able to see the Caller ID when the phone switches the focus to the ringing line.
factory default	Factory default and recovery mode clears the "preferred line" and "preferred line timeout" parameters, and the phone operates in a non-preferred line mode.



Notes:

1. If you specify a value of “0” for the **preferred line** parameter, it disables the preferred line focus feature.
2. If you specify a value of “0” for the **preferred line timeout** parameter, the phone returns the line to the preferred line immediately.

Configuring “Preferred Line” and “Preferred Line Timeout” Using the Aastra Web UI



Aastra Web UI

Use the following procedure to configure the Preferred Line and Preferred Line Timeout feature using the Aastra Web UI.

1. Click on **Basic Settings->Preferences->General**.

Preferences	
General	
Park Call:	<input type="text"/>
Pick Up Parked Call:	<input type="text"/>
Suppress DTMF Playback	<input checked="" type="checkbox"/> Enabled
Display DTMF Digits	<input type="checkbox"/> Enabled
Call Waiting	<input checked="" type="checkbox"/> Enabled
Play Call Waiting Tone	<input checked="" type="checkbox"/> Enabled
Stuttered Dial Tone	<input checked="" type="checkbox"/> Enabled
XML Beep Support	<input checked="" type="checkbox"/> Enabled
Status Scroll Delay (seconds)	<input type="text" value="5"/>
Incoming Call Interrupts Dialing	<input type="checkbox"/> Enabled
Switch UI Focus To Ringing Line	<input checked="" type="checkbox"/> Enabled
Preferred line	<input type="text" value="1"/>
Preferred line Timeout (seconds)	<input type="text" value="0"/>
Goodbye Key Cancels Incoming Call	<input checked="" type="checkbox"/> Enabled
UPnP Mapping Lines	<input type="text" value="0"/>
Message Waiting Indicator Line	<input type="text" value="All"/>
DND Key Mode	<input type="text" value="Phone"/>
Call Forward Key Mode	<input type="text" value="Account"/>
Use LLDP ELIN	<input checked="" type="checkbox"/> Enabled

2. In the “**Preferred Line**” field, select a preferred line to switch focus to after incoming or outgoing calls end on the phone. Default is **1**. Valid values are:

- **None** (disables the preferred line focus feature)
- **1 to 9**

For example, if you set the preferred line to “1”, when a call (incoming or outgoing) ends on the phone (on any line), the phone switches focus back to Line 1.

3. In the “**Preferred Line Timeout**” field, enter the amount of time, in seconds, that the phone switches back to the preferred line after a call (incoming or outgoing) ends on the phone, or after a duration of inactivity on an active line. Default is **0**. Valid values are:

- **0 to 999**

4. Click  to save your changes.

Goodbye Key Cancels Incoming Calls

The 6755i has a feature that allows you to configure the **Goodbye** key to drop a second incoming call or ignore incoming calls presented to the phone when you are on an active call. The parameter is called "**Goodbye Key Cancels Incoming Call**" and is configurable via the Aastra Web UI.

If you enable this parameter, which is the default, pressing the Goodbye key rejects calls coming into the phone while you are on an active call. When you disable this parameter, pressing the Goodbye key hangs up the active call.

If you disable this feature, and the phone receives another call when an active call is already present., the phone displays a softkey 1 as "**Answer**" and softkey 2 as "**Ignore**".

Configuring Goodbye Key to Cancel Incoming Calls



Aastra Web UI

Use the following procedure to configure the Goodbye key to cancel incoming calls on the IP phone.



Note: "Goodbye Key Cancels Incoming Call" is enabled by default.

1. Click on **Basic Settings->Preferences->General**.

Status System Information Operation User Password Phone Lock Softkeys and XML Programmable Keys Keypad Speed Dial Directory Reset Basic Settings Preferences Account Configuration	Preferences General Park Call: <input type="text"/> Pick Up Parked Call: <input type="text"/> Suppress DTMF Playback <input checked="" type="checkbox"/> Enabled Display DTMF Digits <input type="checkbox"/> Enabled Call Waiting <input checked="" type="checkbox"/> Enabled Play Call Waiting Tone <input checked="" type="checkbox"/> Enabled Stuttered Dial Tone <input checked="" type="checkbox"/> Enabled XML Beep Support <input checked="" type="checkbox"/> Enabled Status Scroll Delay (seconds) <input type="text" value="5"/> Incoming Call Interrupts Dialing <input type="checkbox"/> Enabled Switch UI Focus To Ringing Line <input checked="" type="checkbox"/> Enabled Preferred line <input type="text" value="1"/> Preferred line Timeout (seconds) <input type="text" value="0"/> Goodbye Key Cancels Incoming Call <input checked="" type="checkbox"/> Enabled UPnP Mapping Lines <input type="text" value="0"/> Message Waiting Indicator Line <input type="text" value="All"/> DND Key Mode <input type="text" value="Phone"/> Call Forward Key Mode <input type="text" value="Account"/> Use LLDP ELIN <input checked="" type="checkbox"/> Enabled
---	--

2. The "**Goodbye Key Cancels Incoming Call**" field is enabled by default. To disable this field, uncheck the box.
3. Click  to save your settings.

Using the Goodbye Key to Cancel Incoming Calls Feature



IP Phone UI

IF	THEN
" Goodbye Key Cancels Incoming Call " is enabled AND a second call comes in while you are on an active call,	press the Goodbye key to reject the second incoming call.
" Goodbye Key Cancels Incoming Call " is disabled AND a second call comes in while you are on an active call,	press the Goodbye key to hang up on the active call so you can answer the second incoming call.
" Goodbye Key Cancels Incoming Call " is disabled AND a second call comes in while you are on an active call,	press the " Ignore " softkey to ignore the second incoming call and remain on the active call OR press the " Answer " softkey to answer the second incoming call.

UPnP Mapping Lines (for remote phones)

Universal Plug and Play (UPnP) is a standard that uses Internet protocols to enable devices to be plugged into a network and automatically know about each other. With UPnP, when a user plugs a device into the network, the device configures itself, acquires a TCP IP address, and uses a discovery protocol based on the Internet's HTTP or HTTPS URL to announce its presence on the network to other devices.

This method of device discovery on a network is called “Universal Plug and Play” or UPnP. If you enable UPnP, and the phone is discovered on the network, port mappings are set up between the phone and the Internet Gateway Device (IGD) in your network. The phone controls the opening, closing, and polling of ports on the IGD. HTTP and SIP use a single port each. RTP/RTCP uses a range of ports.

You can enable the UPnP mappings to specific lines on your phone. You set this configuration using the Aastra Web UI at *Basic Settings->Preferences->UPnP Mapping Lines*.



Note: UPnP must be enabled on your remote phone before you can configure the UPnP mapping lines. Contact your System Administrator for more information.

Configuring UPnP Mapping Lines



Aastra Web UI

Use the following procedure to configure the UPnP mapping lines on the IP phone.

1. Click on **Basic Settings->Preferences->General**.

<p>Status</p> <ul style="list-style-type: none"> System Information <p>Operation</p> <ul style="list-style-type: none"> User Password Phone Lock Softkeys and XML Programmable Keys Keypad Speed Dial Directory Reset <p>Basic Settings</p> <ul style="list-style-type: none"> Preferences Account Configuration 	<p>Preferences</p> <p>General</p> <ul style="list-style-type: none"> Park Call: <input type="text"/> Pick Up Parked Call: <input type="text"/> Suppress DTMF Playback: <input checked="" type="checkbox"/> Enabled Display DTMF Digits: <input type="checkbox"/> Enabled Call Waiting: <input checked="" type="checkbox"/> Enabled Play Call Waiting Tone: <input checked="" type="checkbox"/> Enabled Stuttered Dial Tone: <input checked="" type="checkbox"/> Enabled XML Beep Support: <input checked="" type="checkbox"/> Enabled Status Scroll Delay (seconds): <input type="text" value="5"/> Incoming Call Interrupts Dialing: <input type="checkbox"/> Enabled Switch UI Focus To Ringing Line: <input checked="" type="checkbox"/> Enabled Preferred line: <input type="text" value="1"/> Preferred line Timeout (seconds): <input type="text" value="0"/> Goodbye Key Cancels Incoming Call: <input checked="" type="checkbox"/> Enabled UPnP Mapping Lines: <input type="text" value="0"/> Message Waiting Indicator Line: <input type="text" value="All"/> DND Key Mode: <input type="text" value="Phone"/> Call Forward Key Mode: <input type="text" value="Account"/> Use LLDP ELIN: <input checked="" type="checkbox"/> Enabled
---	---

2. The "**UPnP Mapping Lines**" field is set to **0** by default. If required, change the setting to a specific line by selecting a line from the list. Valid values are **0** through **10**. The line you select is the line that your remote phone uses to perform Universal Plug and Play on the network you are connecting to.
3. Click  to save your settings.

Message Waiting Indicator

You can configure the Message Waiting Indicator (MWI) to illuminate for a specific line or for all lines. For example, if you configure the MWI LED on line 3 only, the LED illuminates if a voice mail is pending on line 3. If you configure the MWI LED for all lines, the LED illuminates if a voice mail is pending on any line on the phone (lines 1 through 9).

You configure the MWI indicator using the Aastra Web UI.

Configuring Message Waiting Indicator



Aastra Web UI

Use the following procedure to configure the message waiting indicator on a specific line or on all lines on the IP phone.



Note: "Message Waiting Indicator Line" parameter is set to **ALL** lines by default.

1. Click on **Basic Settings->Preferences->General**.

<p>Status</p> <ul style="list-style-type: none"> System Information <p>Operation</p> <ul style="list-style-type: none"> User Password Phone Lock Softkeys and XML Programmable Keys Keypad Speed Dial Directory Reset <p>Basic Settings</p> <ul style="list-style-type: none"> Preferences Account Configuration 	<p>Preferences</p> <p>General</p> <p>Park Call: <input type="text"/></p> <p>Pick Up Parked Call: <input type="text"/></p> <p>Suppress DTMF Playback <input checked="" type="checkbox"/> Enabled</p> <p>Display DTMF Digits <input type="checkbox"/> Enabled</p> <p>Call Waiting <input checked="" type="checkbox"/> Enabled</p> <p>Play Call Waiting Tone <input checked="" type="checkbox"/> Enabled</p> <p>Stuttered Dial Tone <input checked="" type="checkbox"/> Enabled</p> <p>XML Beep Support <input checked="" type="checkbox"/> Enabled</p> <p>Status Scroll Delay (seconds) <input type="text" value="5"/></p> <p>Incoming Call Interrupts Dialing <input type="checkbox"/> Enabled</p> <p>Switch UI Focus To Ringing Line <input checked="" type="checkbox"/> Enabled</p> <p>Preferred line <input type="text" value="1"/></p> <p>Preferred line Timeout (seconds) <input type="text" value="0"/></p> <p>Goodbye Key Cancels Incoming Call <input checked="" type="checkbox"/> Enabled</p> <p>UPnP Mapping Lines <input type="text" value="0"/></p> <p>Message Waiting Indicator Line <input type="text" value="All"/></p> <p>DND Key Mode <input type="text" value="Phone"/></p> <p>Call Forward Key Mode <input type="text" value="Account"/></p> <p>Use LLDP ELIN <input checked="" type="checkbox"/> Enabled</p>
---	---

2. The "Message Waiting Indicator Line" field is set to **ALL** lines by default. If required, change the setting to a specific line by selecting a line from the list. Valid values are **All** and lines **1** through **9**.
3. Click  to save your settings.

Incoming Intercom Call Features

Incoming Intercom

By default, the IP phone allows incoming intercom calls to be automatically answered without having to set up an Icom key on your phone. The phone automatically plays a warning tone when it receives an incoming intercom call. It also mutes the microphone. If the intercom call comes into the phone while an active call is already present, the phone puts the active call on hold and answers the intercom call.

You can change the behavior of how the phone handles incoming intercom calls by enabling/disabling specific parameters using the Aastra Web UI. The following table describes these features.

Incoming Intercom Features in Aastra Web UI	Description
Microphone Mute	Allows you to enable or disable the microphone on the IP phone for Intercom calls made by the originating caller.
Auto Answer	Allows you to enable or disable the IP phone to automatically answer an Intercom call. If auto-answer is enabled on the IP phone, the phone plays a tone (if " Play Warning Tone " is enabled) to alert the user before answering the intercom call. If auto-answer is disabled, the phone rejects the incoming intercom call and sends a busy signal to the caller. Note: Your Administrator can set a time period delay before the phone automatically answers. Contact your System Administrator for more information.
Play Warning Tone	Allows you to enable or disable a warning tone to play when the phone receives an incoming intercom call on an active line.
Allow Barge In	Allows you to enable or disable how the phone handles incoming intercom calls while the phone is on an active call.

Microphone Mute

You can mute or unmute the microphone on the IP phone for intercom calls made by the originating caller. If you want to mute the intercom call, you enable this feature. If you want to unmute (or hear the intercom call), you disable this feature. "**Microphone Mute**" is enabled by default.

Auto-Answer/Play Warning Tone

The auto-answer feature on the IP phone allows you to enable or disable automatic answering for an Intercom call. If “Auto-Answer” is enabled, the phone automatically answers an incoming intercom call. If “Play Warning Tone” is also enabled, the phone plays a tone to alert you before answering the intercom call. If “Auto-Answer” is disabled, the phone rejects the incoming intercom call and sends a busy signal to the caller. **"Auto-Answer"** and **"Play Warning Tone"** are enabled by default.



Note: Your Administrator can set a time period delay before the phone automatically answers. Contact your System Administrator for more information.

Allow Barge In

You can configure whether or not the IP phone allows an incoming intercom call to interrupt an active call. The “Allow Barge In” parameter controls this feature. When you enable this parameter, which is the default value, an incoming intercom call takes precedence over any active call, by placing the active call on hold and automatically answering the intercom call. When you disable this parameter, and there is an active call, the phone treats an incoming intercom call like a normal call and plays the call warning tone. **"Allow Barge In"** is enabled by default.

Configuring Incoming Intercom Settings



Aastra Web UI

Use the following procedure to configure incoming intercom call settings on the IP phone.

1. Click on **Basic Settings->Preferences->Incoming Intercom Settings**.

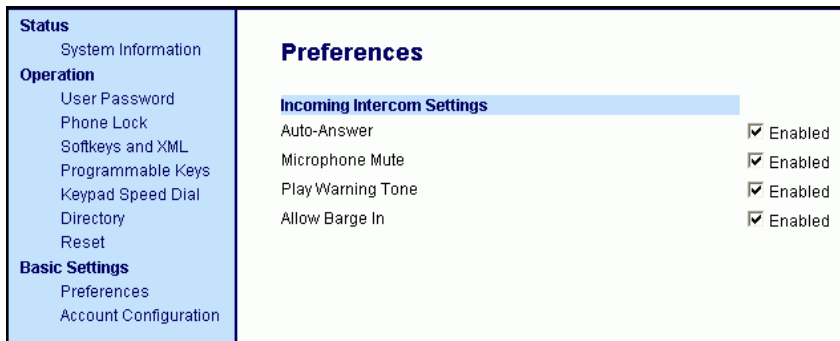

2. The **"Auto-Answer"** field is enabled by default. The automatic answering feature is turned on for the IP phone for answering Intercom calls. To disable this field, uncheck the box.



Note: If the Auto-Answer field is not checked (disabled), the phone rejects the incoming intercom call and sends a busy signal to the caller.

3. The "**Microphone Mute**" field is enabled by default. The microphone is muted on the IP phone for Intercom calls made by the originating caller. To disable this field, uncheck the box.
4. The "**Play Warning Tone**" field is enabled by default. If "Auto-Answer" is enabled, the phone plays a warning tone when it receives an incoming intercom call. To disable this field, uncheck the box.
5. The "**Allow Barge In**" field is enabled by default. If "Allow Barge In" is enabled, the phone puts an active call on hold and answers the incoming Intercom call. To disable this field, uncheck the box.
6. Click  to save your settings.

Using Redial Key for “Last Number Redial”

The IP phone has an enhanced redial user interface that allows a user to quickly redial the last number that was dialed out from the phone. You can:

- Press the REDIAL button twice to redial the last number dialed.
- Press the REDIAL button once, scroll the list of numbers, then press the REDIAL button again to dial the number that displays on the screen.

The “last number redial” feature for the Redial key is static and is not configurable.

Group RTP Paging (receives RTP streams)

You can configure the phone to allow it to receive a Real Time Transport Protocol (RTP) stream from pre-configured multicast address(es) without involving SIP signaling. This is called Group Paging on the IP phones. You can specify up to 5 multicast addresses that the phone listens for on the network. This feature is configurable using the Aastra Web UI only.

The 6755i in the local network listens for RTP on the preconfigured multicast address. The Phone displays the “Paging” message to the phone’s LCD. It uses the G711 uLaw CODEC for multicast RTP.

The recipient can drop the incoming page if required. The recipient can also set Do Not Disturb (DND) to ignore any incoming pages.

For incoming RTP multicasts, the ringing display is dependant on the setting for the “**Allow Barge-In**” parameter. (See “[Allow Barge In](#)” on [page 232](#).) If this parameter is disabled, and there is no other call on the phone, then the paging is automatically played via the default audio device.

If there is an existing call on the phone, the call initially displays in the ringing state. The user has the option to accept/ignore the call. If the “**Allow Barge-In**” parameter is enabled, the RTP multicast call barges in, and any existing calls are put on hold.

If an RTP multicast session already exists on the phone, and the phone receives another incoming RTP multicast session, the priority is given to the first multicast session and the second multicast session is ignored. The behavior for the incoming calls in this case is also based on the setting for the “**Allow Barge-in**” parameter. The incoming call is handled as if there were an existing call already on the phone.

Configuring Group RTP Paging

 Aastra Web UI
--

Use the following procedure to configure RTP streaming on the receiving end for Paging applications using the Aastra Web UI.

1. Click on **Basic Settings->Preferences->Group Paging RTP Settings.**

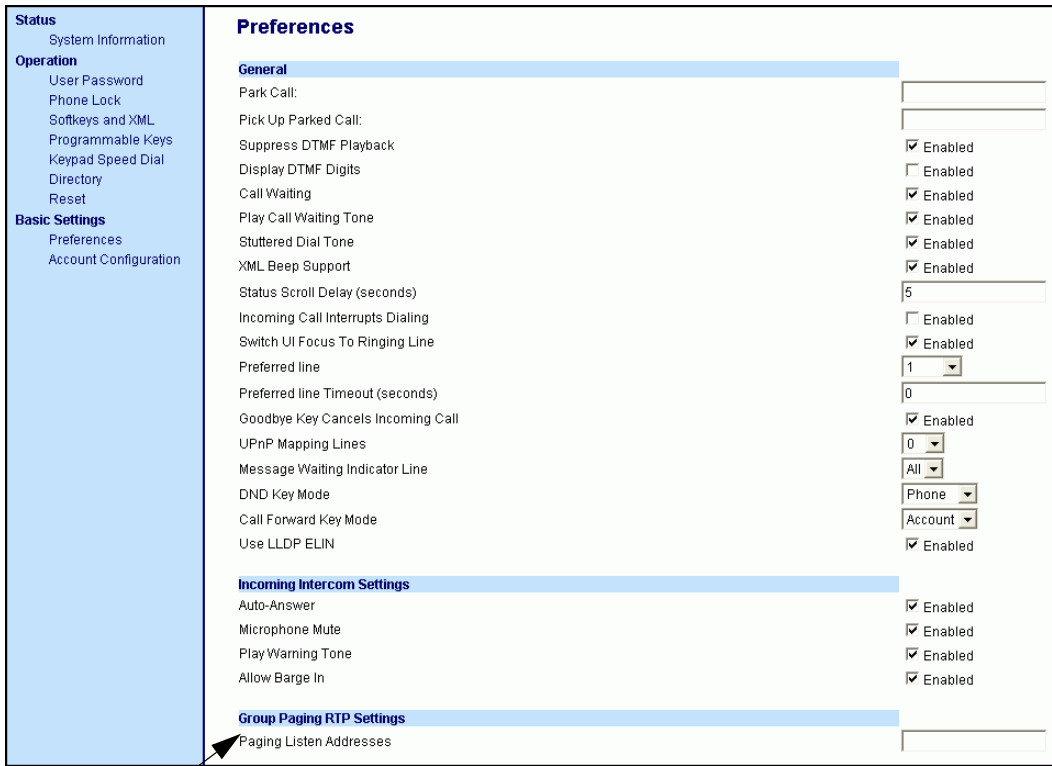

Group Paging RTP Settings

2. In the “Paging Listen Addresses” text box, enter the multicast IP address(es) and port number on which the phone listens for incoming multicast RTP packets.

Enter the IP address in dotted decimal format.
 (for example, 239.0.1.15:10000,239.0.1.20:15000)
 You can enter up to 5 listening multicast addresses.
 If this field is blank, the Paging Listening capability is disabled on the phone.



Notes:

- 1.** Recipient of a Paging call can set a global “Do Not Disturb” (DND) to ignore any incoming pages.

- 2.** For incoming Paging, the phone uses the Intercom configuration settings. The incoming Page is dependant on the “Allow Barge-In” parameter setting and the “Idling/On Call” state.

3. Click  to save your settings.

Use LLDP ELIN

The 6755i IP Phone supports Link Layer Discovery Protocol for Media Endpoint Devices (LLDP-MED), and Explicit Congestion Notification (ECN) Emergency Location Identification Number (ELIN). LLDP ELIN allows the phone to use the location information sent by the switch, as a caller ID for making emergency calls.



Note: If the phone receives location information in ECN ELIN format (10 to 25 numeric string), the phone replaces the caller ID SIP header with the ECN ELIN value and the SIP URI does not change. The phone determines if this is an emergency number by checking the emergency dial plan configured on the phone.

You can enable or disable the LLDP ELIN on the IP Phones using the Aastra Web UI.

For more information about LLDP-MED and LLDP ELIN, contact your System Administrator.

Configuring LLDP ELIN



Aastra Web UI

Use the following procedure to enable or disable LLDP ELIN using the Aastra Web UI.

1. Click on **Basic Settings->Preferences->General**.

Status	Preferences
System Information	
Operation	General
User Password	Park Call: <input type="text"/>
Phone Lock	Pick Up Parked Call: <input type="text"/>
Softkeys and XML	Suppress DTMF Playback <input checked="" type="checkbox"/> Enabled
Programmable Keys	Display DTMF Digits <input type="checkbox"/> Enabled
Keypad Speed Dial	Call Waiting <input checked="" type="checkbox"/> Enabled
Directory	Play Call Waiting Tone <input checked="" type="checkbox"/> Enabled
Reset	Stuttered Dial Tone <input checked="" type="checkbox"/> Enabled
Basic Settings	XML Beep Support <input checked="" type="checkbox"/> Enabled
Preferences	Status Scroll Delay (seconds) <input type="text" value="5"/>
Account Configuration	Incoming Call Interrupts Dialing <input type="checkbox"/> Enabled
	Switch UI Focus To Ringing Line <input checked="" type="checkbox"/> Enabled
	Preferred line <input type="text" value="1"/>
	Preferred line Timeout (seconds) <input type="text" value="0"/>
	Goodbye Key Cancels Incoming Call <input checked="" type="checkbox"/> Enabled
	UPnP Mapping Lines <input type="text" value="0"/>
	Message Waiting Indicator Line <input type="text" value="All"/>
	DND Key Mode <input type="text" value="Phone"/>
	Call Forward Key Mode <input type="text" value="Account"/>
	Use LLDP ELIN <input checked="" type="checkbox"/> Enabled

2. The "Use LLDP ELIN" field is enabled by default. If required, disable this field by unchecking the check box.
3. Click  to save your settings.

Shared Call Appearance (SCA) Call Bridging

Shared Call Appearance (SCA) is when incoming calls are presented to multiple phones simultaneously. For example, it is the ability to assign the boss' extension to a button on the secretary's phone. Calls can be transferred between two phones with the same extension button by simply putting the call on hold at one phone and picking it up on the other. Status LEDs light and flash in unison, allowing all people sharing the extension to see the status at a glance.

The phones include an enhanced SCA for the servers that support call bridging and allows two or more SCA users to be connected in a call with a third party.

Refer to the following example.

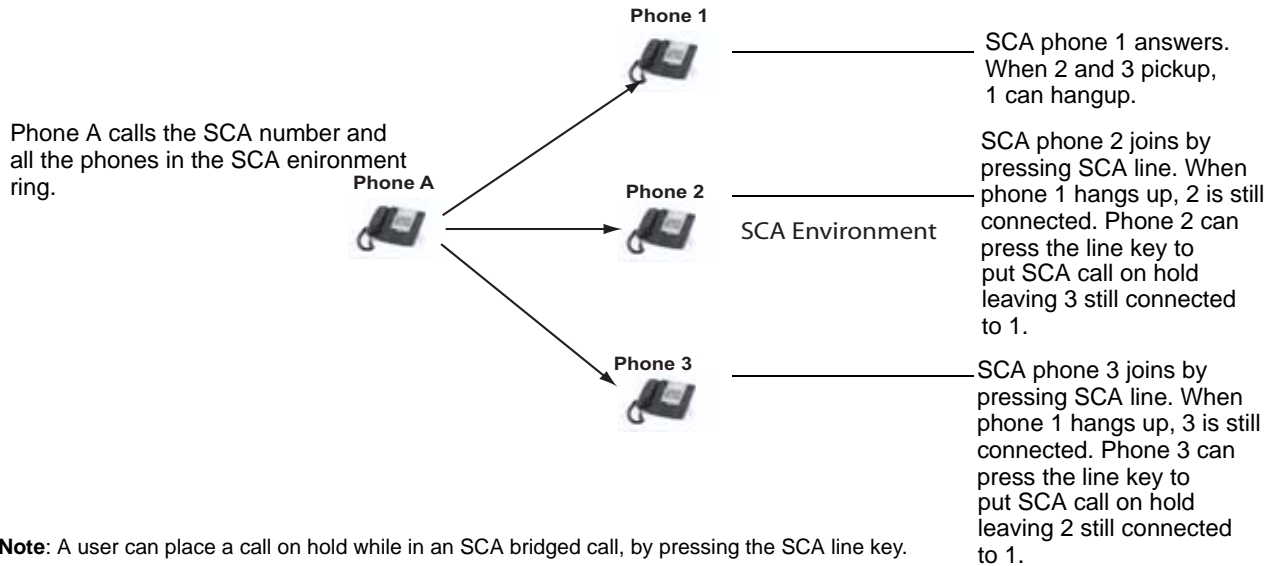

Using the example above, when a call comes into Phone 1, Phone 2 and Phone 3 can pickup the same call by pressing the SCA line key. Phone 2 and 3 display the call they are bridging into on the LCD of the phones. Existing SCA parties in a bridge or one-to-one call hear an audible beep when another party has joined the call.



Note: Your Administrator must enable/disable the beep on the server-side.

If a phone is configured for SCA bridging and it attempts to join a call, but the account on the server does not have this functionality enabled, an error message displays to the LCD on the phone.

The SCA call bridging feature is disabled by default on all phones. Your Administrator can enable/disable this feature if required. Contact your System Administrator for more information.

Keys States and LED Behavior

There are two call states on the phones that support SCA bridging:

- **Bridge-active** - A bridged call is in progress
- **Bridge-held** - The 3rd-party (i.e., non-SCA party) in the bridge is on hold.

The following tables provide the key states and LED behavior in an SCA bridge call for users involved in an SCA call and users not involved in the SCA call.

Line Keys and Idle Screens

State	Call LED	Call Caller ID	Non-Call LED	Non-Call Caller ID
Idle	N/A	N/A	Off	N/A
Seized	Solid Green	None	Solid Red	None
Progressing (outgoing call)	Green	Called Part7	Solid Red	None
Alerting (incoming call)	Blinking Unselected Red	N/A		
Active	Solid Green	Far-end	Solid Red	Far-end
Held	Slow Flashing Green	Far-end	Slow Flashing Red	Far-end
Hold private	Slow Flashing Green	Far-end	Solid Red	Far-end
Bridge-active	Solid Green	Far-end	Solid Red	Far-end
Bridge-held	Slow Flashing Green	Far-end	Solid Red	Far-end

Softkey Line Keys

State	Call Icon	Call LED	Non-Call Icon	Non-Call LED
Idle	Small circle	None	Small circle	None
Seized	N/A	N/A	Sold Circle	Solid Red
Progressing (outgoing call)	Empty circle	Solid Red	Sold Circle	Solid Red
Alerting (incoming call)	Empty blinking circle	Flashing Red	N/A	N/A
Active	Empty circle	Solid Red	Sold Circle	Solid Red
Held	Reverse empty blinking circle	Slow Flashing Red	Sold Reverse Circle	Slow Flashing Red
Hold private	Reverse empty blinking circle	Slow Flashing Red	Sold Circle	Solid Red
Bridge-active	Empty circle	Solid Red	Sold Circle	Solid Red
Bridge-held	Reverse empty blinking circle	Slow Flashing Red	Sold Circle	Solid Red

Programmable Line Keys

State	Call Icon	Call LED	Non-Call Icon	Non-Call LED
Idle	Small circle	None	Small circle	None
Seized	N/A	N/A	Sold Circle	Solid Red
Progressing (outgoing call)	Empty circle	Solid Red	Sold Circle	Solid Red
Alerting (incoming call)	Empty blinking circle	Flashing Red	N/A	N/A
Active	Empty circle	Solid Red	Sold Circle	Solid Red
Held	Reverse empty blinking circle	Slow Flashing Red	Sold Reverse Circle	Slow Flashing Red
Hold private	Reverse empty blinking circle	Slow Flashing Red	Sold Circle	Solid Red
Bridge-active	Empty circle	Solid Red	Sold Circle	Solid Red
Bridge-held	Reverse empty blinking circle	Slow Flashing Red	Sold Circle	Solid Red

Line key Phone Behavior

State	Call Line Key Pressed	Non-Call Line Key Pressed
Idle	N/A	Attempt to seize the line
Seized	Hang up	Ignore
Progressing	Hang up	Ignore
Alerting	answer	N/A
Active	Hold	Bridge
Held	Retrieve	Bridge
Hold private	Retrieve	Ignore
Bridge-active	Hold	Bridge
Bridge-held	Retrieve	Bridge

Available Features Enabled by Administrators

There are features on your IP Phone that you can use **ONLY** if an Administrator has enabled them on your phone. Those features are described in this section. Contact your System Administrator for more information.

Outgoing Intercom Calls

If your System Administrator configures the outgoing intercom feature on your phone, pressing the Icom button allows your phone to find an available line and place an intercom call to a recipient. To use this feature, you must configure an intercom key on your phone. For more information about configuring and using an Icom key, see “[Intercom Key](#)” on [page 139](#).

Missed Call Summary Subscription

A feature on the IP phones allows missed calls that have been redirected by the server, to be incremented in the missed calls indicator on the phone it was initially directed to. This feature is called the **Missed Call Summary Subscription** and can be configured by your System Administrator. For this feature to work, you must configure voicemail on the phone that the call was initially directed to.

For example, phones A, B, and C are connected to the server. Your Administrator configures the server to direct calls coming into phone B (which has voicemail configured) to be forwarded to phone C. When phone A calls phone B, the server forwards the call to phone C. With the **Missed Call Summary Subscription** enabled, phone B receives notification from the server that the call was forwarded and the missed calls indicator is incremented on phone B. See the illustration below.

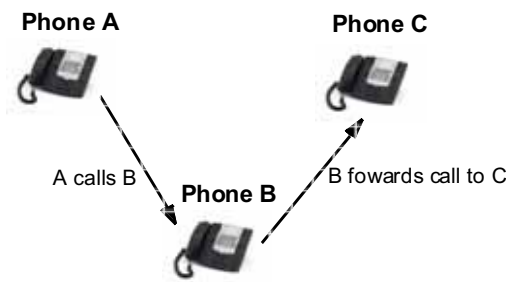

Note: Your System Administrator can configure the **Missed Call Summary Subscription** feature on a global or per-line basis.

Customizable Callers List Key and Services Key

The 6755i IP Phone currently has a Callers List key and a Services key. Your System Administrator can specify an XML URI that creates a custom Callers List and Services application for your phone. When you press the Callers List key or the Services key, the phone accesses a custom XML URI Callers List, or a custom XML URI Service. These services replace the standard functions of the Callers List key and Services key. Contact your System Administrator for more information.

Autodial (Hotline and Warmline)

Your System Administrator can configure an autodial feature on your phone. If autodial is enabled, the phone automatically dials a preconfigured number whenever it is off-hook. Depending on the configuration specified by your Administrator, the Autodial functions as either a “hotline”, or as a “warmline,” as follows:

- **Hotline:** The IP phone immediately dials a preconfigured number when you lift the handset.
- **Warmline:** The IP phone waits for a specified amount of time after you lift the handset before dialing a preconfigured number. If you do not dial a number within the time allotted, then the IP phone begins to dial the number.

The Autodial feature is available on a global or per-line basis. Contact your System Administrator for more information.

**Notes:**

1. Any speedial numbers that you configure on your IP phone are not affected by autodial settings.
 2. If Autodial is configured on your phone, any lines that function as hotlines do not accept conference calls, transferred calls, and/or intercom calls.
-

Centralized Conferencing

The 6755i supports centralized conferencing for Sylanro and Broadsoft servers. This feature provides centralized conferencing on the SIP server (versus localized, on the phone). Your System Administrator must enable this feature on your phone before you can use centralized conferencing.

Centralized Conferencing allows you to perform the following:

- Conference two active calls together into a conference call.
- When on an active conference call, invite another party into the call.
- Create simultaneous conference calls on the same IP phone (Sylanro servers only). For example, a user at extension 2005 could create two conferences, and put one conference on hold while conversing with the other party:

- Line 1: conference together extensions 2005, 2010, and 2020.
- Line 2: conference together extensions 2005, 2011 and 2021.
- Disconnect from an active conference call while allowing the other callers to remain connected.
- Add unlimited number of users to a conference (dependent on the limitations of the server).
- Join two active calls together into a conference.
- Join incoming or outgoing active calls to any existing conference.

Reference

For more information about using Centralized Conferencing, see “[Centralized Conferencing \(for Sylanro and Broadsoft Servers\)](#)” on [page 167](#).

Answer and Ignore Softkeys for XML Applications

If you are accessing XML applications on your phone and a call comes in, your System Administrator can create “**Answer**” and “**Ignore**” keys that you can use to either answer the incoming call, or ignore it.

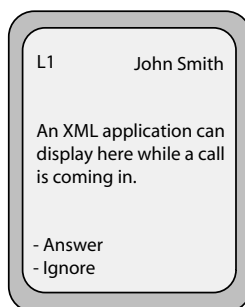

When the 3 Ignore Answer 4 line displays, you can press the **Right Arrow** key (Answer) to answer the incoming call without disturbing the current XML application. When you answer the call, the 3 Ignore Answer 4 line disappears from the LCD. Pressing the **Left Arrow** key (Ignore) ignores the incoming call without disturbing the current XML application. Contact your System Administrator for more information.

XML Softkey for Special Characters in XML Applications

When using XML applications that require you to enter information such as Email addresses, that require special symbols (for example, the “@” symbol), your System Administrator can create an XML softkey to access these symbols. Pressing the symbol key in an XML application can display a single symbol or a list of symbols from which you can choose the symbol you need. Contact your System Administrator for more information.

Playing a WAV File On Your Phone

If enabled by your Administrator, the 6755i IP Phone can play a WAV file. A WAV file is an audio file format standard for storing an audio bit stream on a system in raw, uncompressed format or compressed format to reduce the file size.

A WAV file is streamed to the phone using the HTTP protocol.

The WAV feature supports the following:

- Streaming of the WAV file to allow it to be locally played
- Allows you to abort the audio streaming by pressing the **Goodbye** key on the phone.
- Supports the HTTP file download protocol
- Supports the aLaw and uLaw codecs
- Plays the WAV file only if the phone is idle.
- WAV audio file starts only when 4 seconds of the audio data (or the complete file) has been accumulated.
- Follows the standard phone behavior of speaker/head set/hand set.

IP Phone UI Screen During WAV Streaming

The 6755i screen displays the following during WAV streaming.

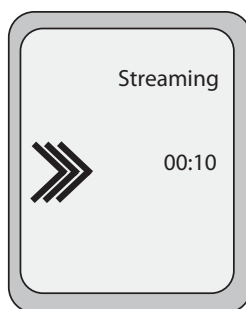

To abort the WAV streaming, press any of the following:

- **Goodbye** key
- **Drop** softkey

You can also place the handset (if in use) on hook.

Using the Keypad During Active XML Applications

If enabled by your Administrator, the 6755i IP Phone can allow you to continue using your keypad keys during active XML applications on your phone. This feature is applicable only when your phone is in the connected state. By default, the phone suppresses dialpad events when an XML object is in focus, so your Administrators must enable the keypad to be used during active XML applications. Contact your System Administrator for more information.

Key Redirection

Conference, Transfer, Redial, Intercom Keys and Voicemail Option

If enabled by your Administrator, the Conference, Transfer, Redial, and Intercom keys, as well as the Voicemail option, can be redirected to XML scripts. This allows the server to provide the phone with Redial, Transfer (Xfer), Conference (Conf), and Intercom (Icom) key features, and the Voicemail option feature, rather than accessing them from the phone-side. By default, the server-side keys function the same as the phone-side key features.

**Notes:**

1. Key remapping takes precedence over redirecting.
 2. Disabling the redial, conference, or transfer features on the phone also disables the redirection of these keys.
-

Contact your System Administrator for more information about this feature.

Options Key

If enabled by your Administrator, the Services Menu on the 6755i IP Phone can be redirected to an XML script. This allows the server to provide the phone with available options, rather than accessing them from the phone-side. You access the XML script by selecting the Services Menu. You can still access the Services Menu from the phone-side by pressing and holding the Options key to display the phone-side Services Menu.

IMPORTANT NOTES

- If no Options URI script is configured, the local Options Menu on the phone displays as normal.
- If you configure password access to the Options Menu, this password is required when accessing the local Option Menu, but is not required for the Options Key redirection feature.
- Pressing the Options Menu for redirection from the server does not interfere with normal operations of the phone (for example, pressing the options menu when on a call does not affect the call).
- If the phone is locked, you must unlock the phone before accessing the Options Menu redirect feature. After pressing the Options Key, the phone displays a screen that allows you to unlock the phone before continuing.
- On the 6755i, the redirection feature works after selecting the Services Menu. To display the original Options Menu, press and hold the Options key.

Contact your System Administrator for more information about this feature.

XML Applications and Off-Hook Interaction

If enabled by your Administrator, the 6755i can be prevented from going into the off-hook/dialing state when the handset is off-hook and the call ends. This feature is disabled by default and must be enabled by your Administrator. The disabled behavior is as follows:

You are in a call using the handset and the phone displays an XML application. The far-end terminates the call, and a new XML application gets pushed/pulled onto the display. Since the handset is off-hook and in idle mode, the "offhook idle timer" starts. When this timer expires, the phone applies dial tone and moves to the off-hook/dialing state, which then destroys the XML application that was being displayed.

Contact your System Administrator for more information about this feature.

XML Override for a Locked Phone

The 6755i has a feature that allows a locked phone to be overridden when an XML application is sent to the phone. This feature also allows you to still use programmable keys/softkeys/expansion module keys applicable to the XML application even though the phone is locked. However, any keys NOT associated with the XML application cannot be used when the phone is locked.

Also, XML Get Requests override the locked feature on the phone so that any softkey or programmable key pressed by the user that initiates a Get Request, continues to get sent.

Only a System Administrator can configure the feature of "XML override for a locked phone":

RTP Recording and Simultaneous Playing

The IP Phones now allow for Real-Time Transport Protocol (RTP) recording and simultaneous playing of an audio file via XML commands created by your Administrator. The RTP and multicast RTP commands allow the phone to send/receive an RTP stream to/from given multicast/unicast addresses (without involving SIP signaling).



Notes:

1. When an RTP stream is being sent with RTP recording and simultaneous playing (mix), the IP Phone LCD displays an icon with an 'm' on top to indicate that a mixed RTP stream is being sent.
 2. When RTP stream is being received with RTP recording and simultaneous playing (mix), you can use the volume controls on the IP phone to adjust the volume (increase or decrease) to your specifications.
-

Contact your System Administrator for more information about this feature.

“Hold” Feature Enhancement (for Broadsoft Servers)

The Hold feature allows you to put an active call on “hold,” then retrieve the call later. This enhancement is intended for IP phones operating with servers that support RFC3264 (for example, Broadsoft). If a server does not support RFC3264, then the IP phones do not use RFC3264 functionality.

Authentication Support for HTTP/HTTPS Download Methods Used with Broadsoft Client Management System (CMS)

If enabled by an Administrator, the 6755i has authentication support when using HTTP or HTTPS as download protocols (as per RFC 2617). When a phone is connected to a Broadsoft Server using the CMS tool, a LOGIN key displays. Pressing the LOGIN key displays a login screen with Username and Password. Username can be up to 40 characters and Password can be up to 20 characters. A System Administrator can optionally configure a Domain Name to be used as the Username (e.g. username@domain.com). A user can navigate the screen using the navigation keys (arrow keys) on the phone. The screen provides a SUBMIT key for submission of the field information, and a CANCEL key for exiting the login screen. Appropriate messages display if the phone reaches a timeout while trying to connect to the server, or if a Username or Password are incorrect.

Once the login information for a specific user is entered and accepted by the server, the phone reboots and downloads the user profile.

IP Phone UI when Broadsoft CMS is Enabled

When the Broadsoft CMS feature is enabled on the IP Phone, the following screens display:

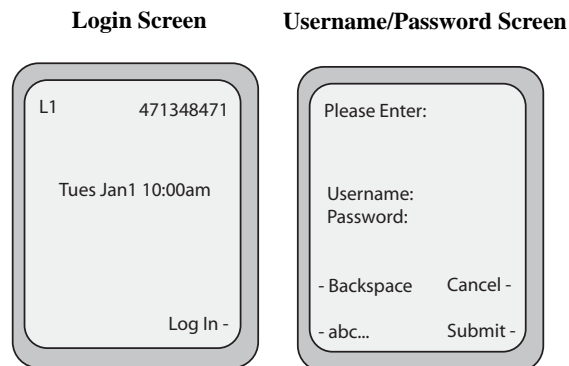

Diverting Calls from Your Phone

Your Administrator can enable/disable a feature on your phone that allows incoming calls to be diverted to another phone if required.

When an outgoing call from your phone is being diverted to another destination (i.e., via call forward), the phone displays the Caller ID (phone number and/or caller name) of the new destination and the reason for the call diversion. Similarly, at the new destination, the Caller ID of the original call destination displays.

Call Diversion Example	
1	Tim calls Mark at x400.
2	Mark's phone is busy.
3	Mark's phone diverts the incoming call to another destination (Roger @ x 464).
4	Tim's phone displays name and extension of where the call is being diverted to and reason for diverting the call. The screen scrolls between Screen 1 and Screen 2.
5	Roger's phone accepts the call and displays the name and number of the phone the incoming call (Tim) and the name (or number) of the original destination (Mark). The screens scroll between Screen 1 and Screen 2..

See examples of the phones' LCD below.

The diversion LCD screens scroll every 3 seconds.

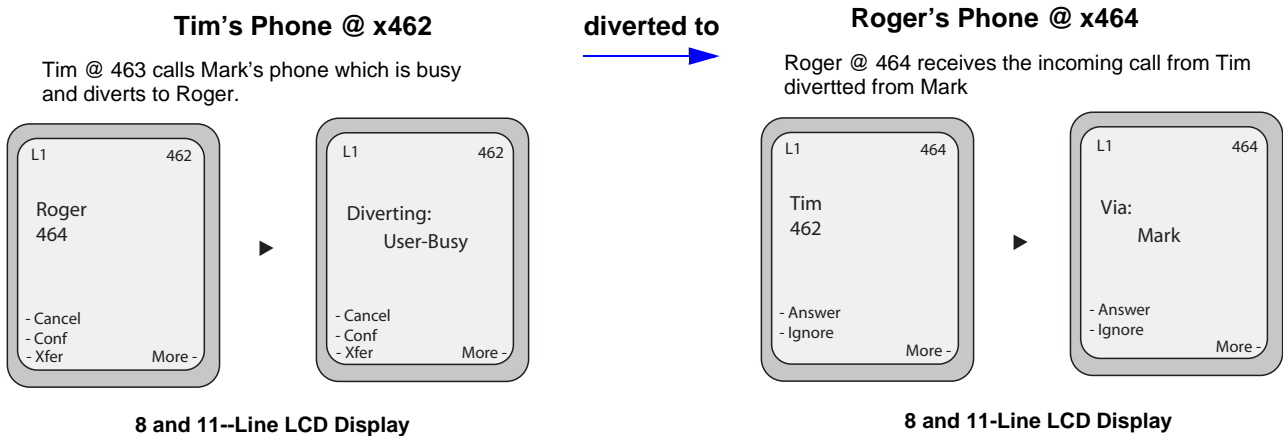

To enable this call diverting feature, contact your System Administrator.

Display of Call Destination Information

By default, your phone displays call destination information if your phone is configured to forward calls to other destinations. The call destination information displays on multiple screens that scroll every 3 seconds. The following example shows call destination information on the 6755i IP Phone.

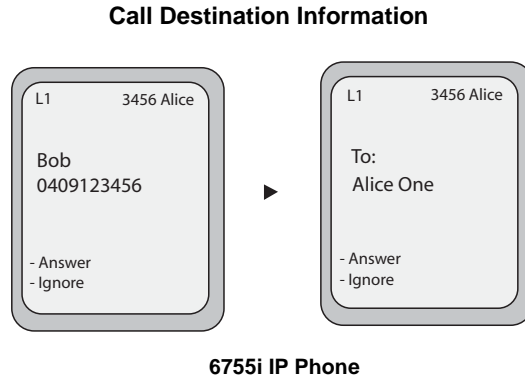

Since Call Diversion is enabled on the phone by default, the following example shows the behavior when call destination is also enabled.

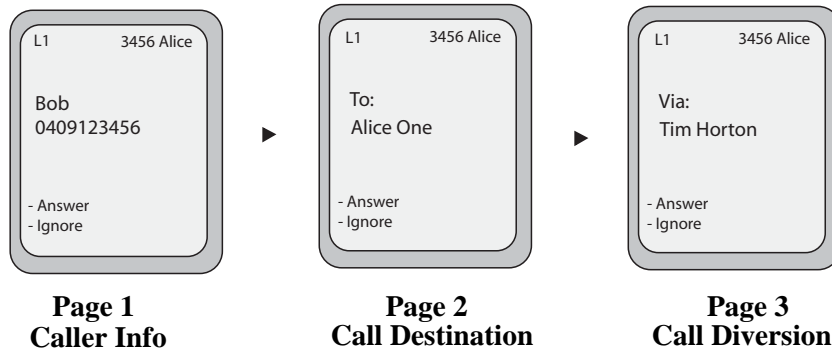

Note: When both call diversion and call destination are enabled, the information displays to the phone's screens in the following order:

- Screen 1** Caller info
- Screen 2** Call destination
- Screen 3** Call diversion

If your phone does not display call destination information, your System Administrator may have disabled this feature. Contact your System Administrator for more information.

Model M670i and M675i Expansion Modules

The 6755i IP Phone offers optional M670i and M675i Expansion Modules that attach to the right side of the phone to provide additional softkeys.

Model M670i

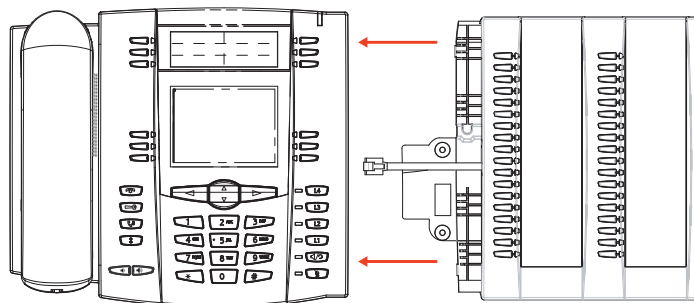

The M670i provides 18 softkeys in each column (totaling 36 keys) on the keypad. Each key provides an LED for indicating call status. The M670i provides a paper label for convenient key labeling.

Model M675i

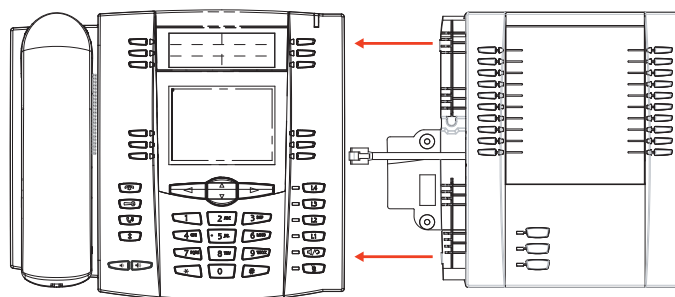

The M675i provides 10 softkeys in each column (totaling 20 keys) on the keypad. The M675i also provides 3 keys at the bottom left of the unit. These keys represent "Page 1", "Page 2", and "Page 3" of the LCD display. The M675i has 20 keys available on each page (totaling 60 softkeys). Each key provides an LED for indicating call status. The M675i provides an LCD for displaying key labels.

Reference

For more information about using the M675i with your phone, see [“Using the Expansion Modules”](#) on page 252.

The Expansion Module keys support the following functions:

- none
- line
- speeddial
- do not disturb (DND)
- Busy Lamp Field (BLF)
- BLF List
- Auto Call Distribution (ACD)
- Directed Call Pickup
- Extensible Markup Language (XML)
- flash
- sprecode
- park
- pickup
- Last Call Return (lcr)
- Call Forward
- BLF/Xfer
- Speeddial/Xfer
- Speeddial/Conf
- Directory
- Callers List
- Intercom
- Services
- Phone Lock
- Paging
- Empty

You can configure the keys using the Aastra Web UI at the path, ***Operation->Expansion Module <N>*** when an Expansion Module is attached to the 6755i IP Phone.

Reference

For more information about configuring the expansion module keys with these functions, see the [“Softkeys and Programmable Keys”](#) on page 61.

Using the Expansion Modules

M670i Expansion Module

After configuring the softkeys on the M670i Expansion Module, you can record the name of the softkey on the paper labels provided with the Expansion Module. Press the softkey you want to use when applicable.

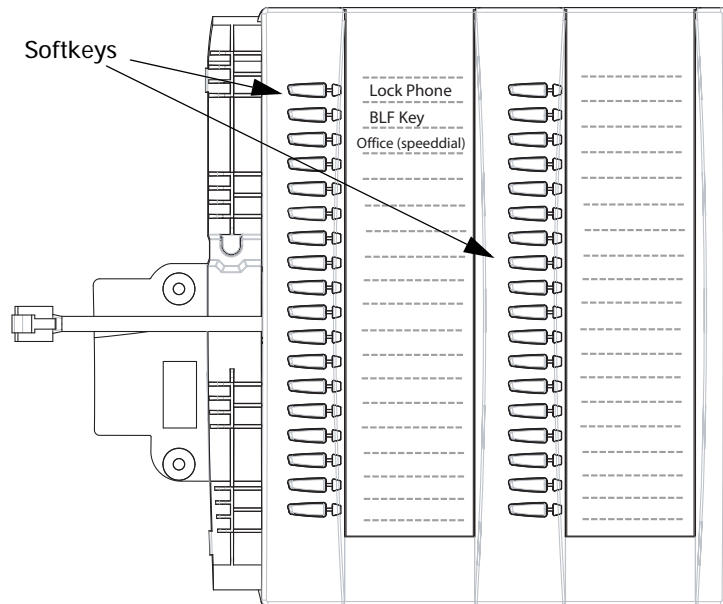

M675i Expansion Module

The M675i Expansion Module screen displays softkeys in column format. The function keys on the bottom left of the Module allow you to display 3 full screens of softkeys. Each screen consists of 2 columns with the following default headings on each page:

Page 1 "List 1" and "List 2"

Page 2 "List 3" and "List 4"

Page 3 "List 5" and "List 6"

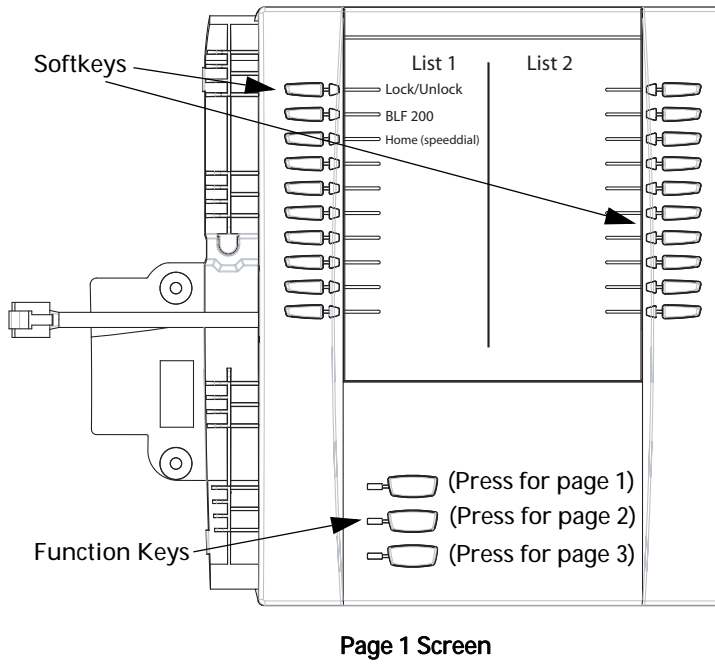

Page 1 Screen

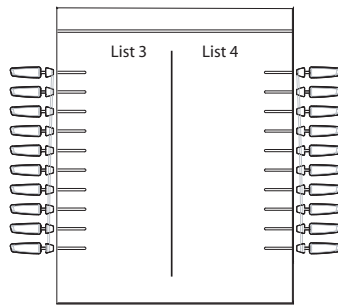

Page 2 Screen

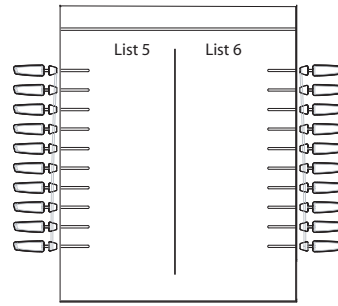

Page 3 Screen

To use the M675i, press the function key for the page you want to display to the LCD (page 1, page2, or page 3), and press the applicable softkey.



Note: Your System Administrator can customize the headings on each M675i Expansion Module screen. Contact your System Administrator for more information.

References

For more information about configuring softkeys, see [Softkeys and Programmable Keys](#) on page 61.

For more information about installing M670i and M675i modules on your phone, see the *Aastra 6755i SIP IP Phone Installation Guide*.

Press-and-Hold to Create a Speeddial Key

You can press and hold an expansion module key to create a speeddial key and configure it the same way you configure a speeddial key on the phone.



For a procedure on creating a speeddial key, see “[Press-and-Hold to Create a Speeddial \(applicable to programmable keys, softkeys, keypad keys, expansion module keys\)](#)” on page 72.

Troubleshooting Solutions

Why is my display blank?

Ensure that power is being provided to your phone. If your network does not provide inline power over Ethernet, you can obtain an additional accessory, the Aastra PoE (Power over Ethernet) inline power supply, to provide power over Ethernet locally to your phone. See the section “**Connecting to the Network and to Power**” in the *Aastra 6755i Installation Guide* for details.

Why is my speakerphone not working?

If you press the  button and the speaker light flashes and you do not hear dial tone through the speaker phone, the Set Audio option in the phone’s Options list has been set up for headset use. Press  a second time and if the light goes out, the phone has been set up to be used only with a headset or handset. If the light stays on steady and you hear dial tone, the phone has been set up so that you can alternate between the speakerphone and the headset by pressing . See the section “**Set Audio**” on [page 34](#) for instructions on how to change the Set Audio option.

Why can’t I get a dial tone?

Check for any loose connections and that the phone has been installed properly. For installation instructions, please refer to the “**Installation and Setup**” section in the *Aastra 6755i Installation Guide* provided with your phone.

Why doesn’t my phone ring?

Check the ring volume on your phone. It may be turned down or turned off. To adjust the ringer volume setting, press the volume button when the phone is on-hook and idle. For more information, refer to the “**Adjusting Volume section**” in the *Aastra 6755i Installation Guide* provided with your phone.

Why is the light not coming on with a new Voice Mail Message?

Your phone system or service provider must provide “Visual” Message Waiting service for this function to work. Check with your System Administrator for more information.

Why is my handset not working?

Check to ensure that the handset cord is fully connected to both the phone and handset. See the section “**Connecting a Handset or Headset**” in the *Aastra 6755i Installation Guide* for information.

What are services, and how do I use them?

Services on the IP phone include:

- XML Applications
- Callers List
- Directory List
- Voicemail

See the section, “[Services Key](#)” on [page 132](#) more information about the options available under "Services".

How do I find the IP address of my phone?

Instructions on where to find the IP address of your phone can be found in this guide in the section, “[Finding Your Phone’s IP Address](#)” on [page 23](#).

Why does my phone display the “No Service” message?

The phone displays the “**No Service**” message if the SIP settings have not been set up correctly. Contact your System Administrator for more information.

How do I change my user password?

You can change the user password from the IP phone UI or the Aastra Web UI.



IP Phone UI

1. Press  on the phone to enter the Options List.
2. Select **User Password** and press **Enter**.
3. Enter the current user password and press **Enter**.
4. Enter the new user password and press **Enter**.
5. Re-enter the new user password and press **Enter**.
A message, "*Password Changed*" displays on the screen.



1. Click on **Operation->User Password**.

Status
System Information

Operation
User Password
Phone Lock
Softkeys and XML
Programmable Keys
Keypad Speed Dial
Directory
Reset

Basic Settings
Preferences
Account Configuration

Reset User Password

Please enter the current and new passwords

Current Password

New Password

Password Confirm

Save Settings

2. In the "**Current Password**" field, enter the current user password.



Note: By default, the user name is "user" (not case sensitive) and the password field is left blank. If you have forgotten your password, contact your System Administrator for assistance.

3. In the "**New Password**" field, enter the new user password.
4. In the "**Password Confirm**" field, enter the new user password again.
5. Click  to save your changes.

For information about changing your password, see "[User Password](#)" on [page 52](#).

Why does my phone display "Bad Encrypted Config"?

The IP phone displays "Bad Encrypted Config" because encrypted configuration files are enabled but the decryption process has failed.

Report this error to your System Administrator.

How do I restart the IP phone?



IP Phone UI

1. Press the button on the phone to enter the Option List.
2. Use the 2 key to scroll down the list of options to **Phone Status** and press the 4 key to select.
3. Press the 2 key to scroll to the **Restart Phone** option.
4. Press the 4 key to confirm and restart the phone. If you do not wish to restart your phone, press the 3 key to cancel.



Note: Your phone is out of service temporarily during the restart and downloading process.



Aastra Web UI

1. Click on **Operation->Reset**.

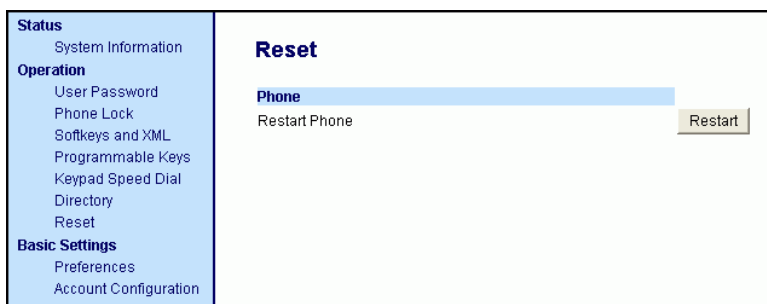

2. Click .
3. Click **OK** at the confirmation prompt.

How do I lock my phone?

You can lock your phone to prevent the phone from being used or configured. You can lock the phone using any of the following:

- At the path *Options->Phone Lock* on the IP Phone UI.
- At the path *Operations->Phone Lock* on the Aastra Web UI.
- At a configured key on the phone. For more information about configuring a Lock/Unlock key on your phone, see [“Paging Key \(Sends the RTP Stream\)”](#) on page 143.

Use the following procedures to lock an IP phone and prevent it from being used or configured.



IP Phone UI

Lock the Phone

1. Press on the phone to enter the Options List.
2. Select **Phone Lock** and press **Enter**.
3. Press 4 to set the phone to lock.
4. Press on the phone.
The following message displays:
"Phone is locked".

Unlock the Phone

1. Press on the phone to enter the Options List.
2. Enter your user password and press **Enter**.
The phone unlocks.



Aastra Web UI

1. Click on **Operation->Phone Lock**.

<p>Status</p> <ul style="list-style-type: none"> System Information <p>Operation</p> <ul style="list-style-type: none"> User Password Phone Lock Softkeys and XML Programmable Keys Keypad Speed Dial Directory Reset <p>Basic Settings</p> <ul style="list-style-type: none"> Preferences Account Configuration 	<p>Phone Lock</p> <p>Lock or unlock the phone</p> <p>Emergency Dial Plan <input type="text" value="911 999 112 110"/></p> <p>Lock the phone? <input type="button" value="Lock"/></p> <p>Reset User Password <input type="button" value="Reset"/></p> <p><input type="button" value="Save Settings"/></p>
---	--

Lock the Phone

2. In the "**Lock the Phone?**" field, click .
The phone locks dynamically and displays the following message:
"Phone is locked".

Unlock the Phone

3. Click on **Operation->Phone Lock**.
4. In the "**Unlock the Phone?**" field, click .
The phone unlocks dynamically and displays the following message:
"Phone is unlocked".

Limited Warranty

Aastra Telecom warrants this product against defects and malfunctions during a one (1) year period from the date of original purchase. If there is a defect or malfunction, Aastra Telecom shall, at its option, and as the exclusive remedy, either repair or replace the telephone set at no charge, if returned within the warranty period.

If replacement parts are used in making repairs, these parts may be refurbished, or may contain refurbished materials. If it is necessary to replace the telephone set, it may be replaced with a refurbished telephone of the same design and color. If it should become necessary to repair or replace a defective or malfunctioning telephone set under this warranty, the provisions of this warranty shall apply to the repaired or replaced telephone set until the expiration of ninety (90) days from the date of pick up, or the date of shipment to you, of the repaired or replacement set, or until the end of the original warranty period, whichever is later. Proof of the original purchase date is to be provided with all telephone sets returned for warranty repairs.

Exclusions

Aastra Telecom does not warrant its telephone sets to be compatible with the equipment of any particular telephone company. This warranty does not extend to damage to products resulting from improper installation or operation, alteration, accident, neglect, abuse, misuse, fire or natural causes such as storms or floods, after the telephone is in your possession.

Aastra Telecom shall not be liable for any incidental or consequential damages, including, but not limited to, loss, damage or expense directly or indirectly arising from the customer's use of or inability to use this telephone, either separately or in combination with other equipment. This paragraph, however, shall not apply to consequential damages for injury to the person in the case of telephones used or bought for use primarily for personal, family or household purposes.

This warranty sets forth the entire liability and obligations of Aastra Telecom with respect to breach of warranty, and the warranties set forth or limited herein are the sole warranties and are in lieu of all other warranties, expressed or implied, including warranties or fitness for particular purpose and merchantability.

Warranty Repair Services

Should the set fail during the warranty period;

In North America, please call 1-800-574-1611 for further information.

Outside North America, contact your sales representative for return instructions.

You will be responsible for shipping charges, if any. When you return this telephone for warranty service, you must present proof of purchase.

After Warranty Service

Aastra Telecom offers ongoing repair and support for this product. This service provides repair or replacement of your Aastra Telecom product, at Aastra Telecom's option, for a fixed charge. You are responsible for all shipping charges. For further information and shipping instructions;

In North America, contact our service information number: 1-800-574-1611.

Outside h America, contact your sales representative.



Note: Repairs to this product may be made only by the manufacturer and its authorized agents, or by others who are legally authorized. This restriction applies during and after the warranty period. Unauthorized repair will void the warranty.

Appendix A - Time Zone Codes

The following table identifies the time zone name and time zone code to use on the IP phone.

Time Zone Name/Time Zone Code Table

Time Zone Name	Time Zone Code
AD-Andorra	CET
AE - Dubai	GST
AG-Antigua	AST
AI-Anguilla	AST
AL-Tirane	CET
AN-Curacao	AST
AR-Buenos Aires	ART
AS-Pago Pago	BST
AT-Vienna	CET
AU-Lord Howe	LHS
AU-Tasmania	EST
AU-Melbourne	EST
AU-Sydney	EST
AU-Broken Hill	CST
AU-Brisbane	EST
AU-Lindeman	EST
AU-Adelaide	CST
AU-Darwin	CST
AU-Perth	WST
AW-Aruba	AST
AZ - Baku	AZT
BA-Sarajevo	EET
BB-Barbados	AST
BE-Brussels	CET
BG-Sofia	EET
BM-Bermuda	AST
BO-La Paz	BOT
BR-Noronha	FNT
BR-Belem	BRT
BR-Fortaleza	BRT
BR-Recife	BRT
BR-Araguaina	BRS
BR-Maceio	BRT
BR-Sao Paulo	BRS
BR-Cuiaba	AMS
BR-Porto Velho	AMT
BR-Boa Vista	AMT
BR-Manaus	AMT
BR-Eirunepe	ACT
BR-Rio Branco	ACT
BS-Nassau	EST
BY-Minsk	EET
BZ-Belize	CST

Appendix A - Time Zone Codes

Time Zone Name	Time Zone Code
CA-Newfoundland	NST
CA-Atlantic	AST
CA-Eastern	EST
CA-Saskatchewan	EST
CA-Central	CST
CA-Mountain	MST
CA-Pacific	PST
CA-Yukon	PST
CH-Zurich	CET
CK-Rarotonga	CKS
CL-Santiago	CLS
CL-Easter	EAS
CN-China	CST
CO-Bogota	COS
CR-Costa Rica	CST
CU-Havana	CST
CY-Nicosia	EES
CZ-Prague	CET
DE-Berlin	CET
DK-Copenhagen	CET
DM-Dominica	AST
DO-Santo Domingo	AST
EE-Tallinn	EET
ES-Madrid	CET
ES-Canary	WET
FI-Helsinki	EET
FJ-Fiji	NZT
FK-Stanley	FKS
FO-Faeroe	WET
FR-Paris	CET
GB-London	GMT
GB-Belfast	GMT
GD-Grenada	AST
GE - Tbilisi	GET
GF-Cayenne	GFT
GI-Gibraltar	CET
GP-Guadeloupe	AST
GR-Athens	EET
GS-South Georgia	GST
GT-Guatemala	CST
GU-Guam	CST
GY-Guyana	GYT
HK-Hong Kong	HKS
HN-Tegucigalpa	CST
HR-Zagreb	CET
HT-Port-au-Prince	EST
HU-Budapest	CET
IE-Dublin	GMT
IS-Reykjavik	GMT
IT-Rome	CET
JM-Jamaica	EST
JP-Tokyo	JST

Time Zone Name	Time Zone Code
KY-Cayman	EST
LC-St Lucia	AST
LI-Vaduz	CET
LT-Vilnius	EET
LU-Luxembourg	CET
LV-Riga	EET
MC-Monaco	CET
MD-Chisinau	EET
MK-Skopje	CET
MQ-Martinique	AST
MS-Montserrat	AST
MT-Malta	CET
MU - Mauritius	MUT
MX-Mexico City	CST
MX-Cancun	CST
MX-Merida	CST
MX-Monterrey	CST
MX-Mazatlan	MST
MX-Chihuahua	MST
MX-Hermosillo	MST
MX-Tijuana	PST
NI-Managua	CST
NL-Amsterdam	CET
NO-Oslo	CET
NR-Nauru	NRT
NU-Niue	NUT
NZ-Auckland	NZS
NZ-Chatham	CHA
OM - Muscat	GST
PA-Panama	EST
PE-Lima	PES
PL-Warsaw	CET
PR-Puerto Rico	AST
PT-Lisbon	WET
PT-Madeira	WET
PT-Azores	AZO
PY-Asuncion	PYS
RO-Bucharest	EET
RU-Kaliningrad	EET
RU-Moscow	MSK
RU-Samara	SAM
RU-Yekaterinburg	YEK
RU-Omsk	OMS
RU-Novosibirsk	NOV
RU-Krasnoyarsk	KRA
RU-Irkutsk	IRK
RU-Yakutsk	YAK
RU-Vladivostok	VLA
RU-Sakhalin	SAK
RU-Magadan	MAG
RU-Kamchatka	PET
RU-Anadyr	ANA

Appendix A - Time Zone Codes

Time Zone Name	Time Zone Code
SE-Stockholm	CET
SG-Singapore	SGT
SI-Ljubljana	CET
SK-Bratislava	CET
SM-San Marino	CET
SR-Paramaribo	SRT
SV-El Salvador	CST
TR-Istanbul	EET
TT-Port of Spain	AST
TW-Taipei	CST
UA-Kiev	EET
US-Eastern	EST
US-Central	CST
US-Mountain	MST
US-Pacific	PST
US-Alaska	AKS
US-Aleutian	HAS
US-Hawaii	HST
UY-Montevideo	UYS
VA-Vatican	CET
YU-Belgrade	CET

Index

Numerics

6755i

- additional features of 211
- features of 2
- line settings 60
- making calls 152
- requirements of 2

A

Aastra Web UI

- Basic Settings parameters 21
- Operaton parameters 20
- phone status 20

about this guide 1

account configuration 188

ACD key 90

allow barge-in, for intercom 232

answering incoming calls 159

auto-answer, for intercom 232

autodial (hotline and warmline) 242

B

backlight, setting 31

bad encrypted config 257

BLF key 84

BLF List key 87

BLF List, setting softkey for 87

BLF, setting softkey for 85

BLF/Xfer 123

BLF/Xfer key 123

BLF/Xfer, softkeys for 124, 127, 130

C

call destination, displaying 249

Call Forward key 121

call forwarding, softkeys for 121

call waiting tone 217

callers list 183

- deleting entries in 186
- downloading to phone 182, 187
- editing 185

using 184

using on phone 184

Callers List key 137

callers list key, customizable 242

callers list, softkey for 137

calls

receiving 159

calls, ending 171

calls, transferring 163

conferencing

ending 170

transfer remaining parties 170

conferencing calls 165

conferencing, centralized 242

contrast level, setting 30

D

DCP key 95

deleting a key 151

dial plan, emergency 58

dial tones, stuttered 218

dialing

pre-dialling a number 153

dialing a number 152

dialpad, live 33

Directory key 135

directory key, softkey for 135

directory list 172

adding and editing entries 174

arranging entries 177

deleting numbers and labels for an entry 178

downloading to PC 181

limitations for 174

scrolling multiple screens 176

sorting 173

using 182

diverting calls 248

DND key 82

DND, enabling/disabling 188, 193

do not disturb, setting softkey for 82

documentation 1

Index

DTMF digits, displaying 213
DTMF, suppressing playback 211

E

emergency dial plan, defining 58
Empty key 149
empty key, softkey for 147, 149
expansion module, M670i and M675i 250
expansion module, M675i 250

F

Flash key 108

G

GCP key 95
getting started 4
Goodbye key cancels incoming call 226
 configuring 226
 using 227
group RTP paging 235

H

handling calls 161
headset mic 154
headset mode 34
headset, using 154
headset/speaker mode 34
held calls, retrieving 162
hold, automatic 162
hold, feature enhancement for 247

I

idle screen 8
incoming call interrupts dialing 221
installation and setup, 9122i 3
intercom calls
 incoming call features 231
Intercom key 139
Intercom key, softkey for 139
intercom, outgoing calls using 241
Intercom, using 155
Introduction 261

introduction 2
IP address, finding 23, 256

K

key descriptions 12
key redirection 245
keys
 ACD key 90
 BLF key 84
 BLF List key 87
 BLF/Xfer key 123
 Call Forward key 121
 Callers List key 137
 DCP and GCP 95
 deleting 151
 Directory key 135
 DND key 82
 Empty key 149
 Flash key 108
 Intercom key 139
 Last Call Return (lcr) 119
 Line key 67
 None key 147
 Paging key 143
 Park and Pickup keys 112
 Phone Lock key 141
 Services key 132
 Speeddial/Conf key 129
 Speeddial/Xfer key 126
 Sprecode key 110
 XML key 101

L

language
 latin 2 character set 51
 overview 44
 specifying on IP phone 44
last call return, softkeys for 119
LCR key 119
Line key 67
line, setting a softkey for 69
LLDP ELIN 237
lock/unlock the phone 56, 259

Index

M

- M670i 250
- M675i 250
- making calls 152
- managing calls 172
- message waiting indicator, configuring 230
- microphone mute, for intercom 231
- microphone volume, headset 35
- missed call summary subscription 241
- missed calls indicator
 - accessing and clearing 209
 - overview 209
- multiple line call appearances 60

N

- network disconnected 7
- no service 256
- None key 147

O

- on-hold calls 161
- options
 - setting via the phone UI 15
 - setting via the Web UI 18

P

- Paging key 143
- paging, softkeys for 143
- park and pickup
 - configuring 115
 - using on phone 118
- Park and Pickup keys 112
- park static configuration 112
- park/pickup
 - configuring a static configuration 114
- password, resetting user's 54
- phone lock 56
- Phone Lock key 141
- pickup static configuration 112
- playing a WAV file 244
- plugging in the phone 4

- preferred line 224
- preferred line timeout 224
- programmable keys 61

R

- redial 157
- restarting the phone 55
- ring tone sets 28
- ring tones 27
- RTP paging, group 235

S

- Services key 132
- services key, customizable 242
- softkeys 61
 - answer softkey for XML 243
 - ignore softkey for XML 243
 - special character softkey for XML 243
 - state-based 64
- speaker mode 34
- speaker/headset mode 34
- Speeddial
 - creating using function keys 76
 - creating using Keypad Speeddial 77
 - creating using Speed Dial Edit 74
 - editing 80
- speeddial
 - assigning as softkey or programmable key 71
 - creating from Keypad Speeddial in Web UI 77
 - prefix 71
- Speeddial key 71
 - press-and-hold 72
- speeddial keys, editing 78
- speeddial/Xfer 126
- Speeddial/Xfer key 126
- Sprecode key 110
- sprecode, setting key for 110
- star codes 211
- starting up the phone 4
- status scroll delay 220
- switch UI focus to ringing line 223

Index

Index

T

- time and date 37
- time and date format 37
- transferring calls, blind 163
- transferring calls, consultative 163
- troubleshooting solutions 255
 - changing user password 256
 - display blank 255
 - finding IP address 256
 - handset not working 255
 - locking/unlocking phone 259
 - no dial tone 255
 - no ring 255
 - no speakerphone 255
 - phone displays "Bad Encrypted Config" 257
 - phone displays "No Service" 256
 - restarting the phone 258
 - using services 256
 - VM message light not working 255

U

- UPnP mapping lines 228
- user password 52

V

- voicemail 160, 210

W

- warning tone, for Intercom 232
- warranty, limited 261
- Web UI, using 18

X

- XML application title 101
- XML application URI 101
- XML beep support 219
- XML features 244, 246
- XML key 101
- XML services
 - accessing 106

Aastra Telecom will not accept liability for any damages and/or long distance charges, which result from unauthorized and/or unlawful use.

While every effort has been made to ensure accuracy, Aastra Telecom will not be liable for technical or editorial errors or omissions contained within this documentation. The information contained in this documentation is subject to change without notice.

